

LIGHTING DESIGN GUIDE

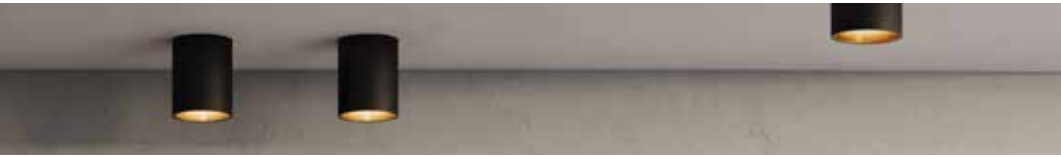

2025



dals





# Our mission is to offer the highest level of service and quality through an innovative, functional and complete product line.

DALS Lighting is a manufacturer of designer lighting products with a focus on innovation and emerging technologies. Our systems are showcased in lighting showrooms, retailers, electrical distributors, and e-commerce platforms. Additionally, they are specified in projects across North

America through a robust network of agents collaborating with architects, engineers, contractors, and distributors. We are dedicated to providing exceptional service, fast lead times, environmentally conscious solutions, and superior product quality.









## OUR MILESTONES

### 2008

DALS Lighting Inc. was founded and quickly established itself as a leader in accent lighting by introducing an innovative LED product line.

### 2009 - 2015

Building on early success, DALS shifted all product lines to LED technology and prioritized best-in-class service. This focus on innovation and quality culminated in the launch of the LED Design Guide in 2015, showcasing cutting-edge products and exclusive LED solutions. DALS also opened its first LED lighting showroom at the Dallas Market Center in Dallas, Texas, solidifying its position in the North American market.

### 2016

To support continued growth, DALS moved into a new headquarters in Blainville, Quebec, Canada, and expanded its U.S. operations in Coral Springs, Florida.

### 2017-2022

DALS entered the smart home market with the launch of its smart home ecosystem, featuring connected products controlled through the DALS mobile app. A dedicated team was established to drive innovation in this category. During this period, DALS accelerated its product launch cadence, introduced the DALS Connect and DALS Connect PRO smart platforms, and expanded into landscape lighting. In 2020, the company unveiled a new atrium showroom at the Dallas Market Center, which contributed to substantial growth.

### 2023

DALS doubled the size of its headquarters and main warehouse, underscoring its commitment to operational excellence and scalability. This expansion was paired with a strategic financial partnership, positioning the company for its next phase of accelerated development.

### 2024

DALS achieved several significant milestones in 2024. The company delivered its largest-ever product launch, introduced an expanded range of offerings, and began exhibiting at LEDucation, further establishing its presence in the lighting industry. The team continued to grow, reinforcing DALS's dedication to operational excellence and innovation.

### 2025

Heading into 2025, DALS is excited to introduce new products featuring innovative designs and enhanced technical features. The company remains committed to continuously improving its offerings while thoughtfully exploring strategic opportunities to strengthen its market position. With a focus on team development and operational excellence, DALS is dedicated to delivering exceptional service and value to its customers.

Symbols provide a quick visual reference for key product features, compliance standards, and performance attributes. Strategically integrated into product descriptions throughout the catalog, their meanings are detailed in the accompanying legend for accurate interpretation. These symbols are designed to help you make informed decisions with confidence.



---

### New Product

This symbol indicates a new product launching this year. Look through the catalog to discover these exciting additions and find detailed specifications for each.



---

### Product Upgrade

This symbol signifies that an existing product has been extensively enhanced to improve its features or performance.



---

### Low-Glare

The recessed positioning of the LED module in this series of downlights effectively minimizes glare, providing a more comfortable lighting experience.



---

### Change Colors

The RGB+CCT color-changing light allows you to choose your favorite color to create different atmospheres or use it for general illumination, with a range from warm to cool white.



---

### Air tight

Air tight fixtures, tested to meet ASTM E283-04 standards, are designed to prevent air leakage through ceiling holes, improving energy efficiency and maintaining consistent indoor temperatures.



---

### Title 24/JA8

This certification ensures that the lighting control system meets the requirements of California's Title 24 energy code, specifically the JA8 section, which focuses on high-efficacy lighting. It ensures that the system is designed, installed, and programmed correctly for compliance with energy efficiency standards.



---

### Multi-Voltage

This symbol indicates that a product family offers multi-voltage drivers (120V/277V/347V) that are compatible with 0-10V dimming systems.



---

### Fire Rated

Fire-rated recessed lights feature fire-resistant housings and seals designed to prevent the spread of fire through ceiling or wall openings, ensuring safety and compliance with building codes.

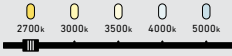

### CCT Switch

These lights allow you to adjust the color temperature, offering a range from warm white to cool white within a single fixture.



### Dry Location

Dry-rated lights are not designed to protect against condensation and should not come into contact with water. However, these fixtures can withstand brief exposure to moisture, provided there is proper ventilation.

### IC

### IC Rated

“IC” stands for Insulation Contact. The IC rating indicates whether a recessed downlight is safe to come into contact with your home’s insulation.



### Multi-Wattage

A multi-wattage light fixture is designed to offer adjustable brightness levels by incorporating varying wattages within the fixture, providing flexibility to meet different lighting needs.



### Damp Rated

Damp-rated lights are designed for areas with occasional moisture exposure, but not for locations with constant or direct water contact. For example, these fixtures can be used to illuminate areas directly outside your shower.



### Wet Rated

Wet-rated lighting fixtures are designed for areas with direct exposure to water, though they cannot be submerged. These fixtures use waterproof seals to protect their internal components from moisture.

### ADA

### ADA Compliant

The ADA sets standards for light fixture installations in public buildings. To be ADA compliant, fixtures must not extend more than 4 inches into hallways, walkways, or corridors, helping to prevent hazards for individuals with disabilities.



### Bluetooth Compatible

This smart light is Bluetooth-compatible and can be seamlessly integrated into your DALI Connect ecosystem for enhanced control and functionality.



### Motion Sensor

This symbol indicates that the light fixture features responsive technology, detecting movement nearby and automatically activating the light for improved efficiency and convenience.



### Coastal Friendly

These fixtures resist rust, corrosion, fading, and wear from salt air, extreme temperatures, and UV exposure. Approved for 480h salt spray testing, they offer durability equivalent to 6.5 years in coastal conditions.



### Gravity Glide

The Gravity Glide height adjustment feature allows you to easily raise or lower a pendant lamp by simply pulling or pushing the cord.



### Dark Sky Friendly

Dark sky friendly fixtures are designed to minimize light pollution by directing light downward, helping to preserve the natural night sky.

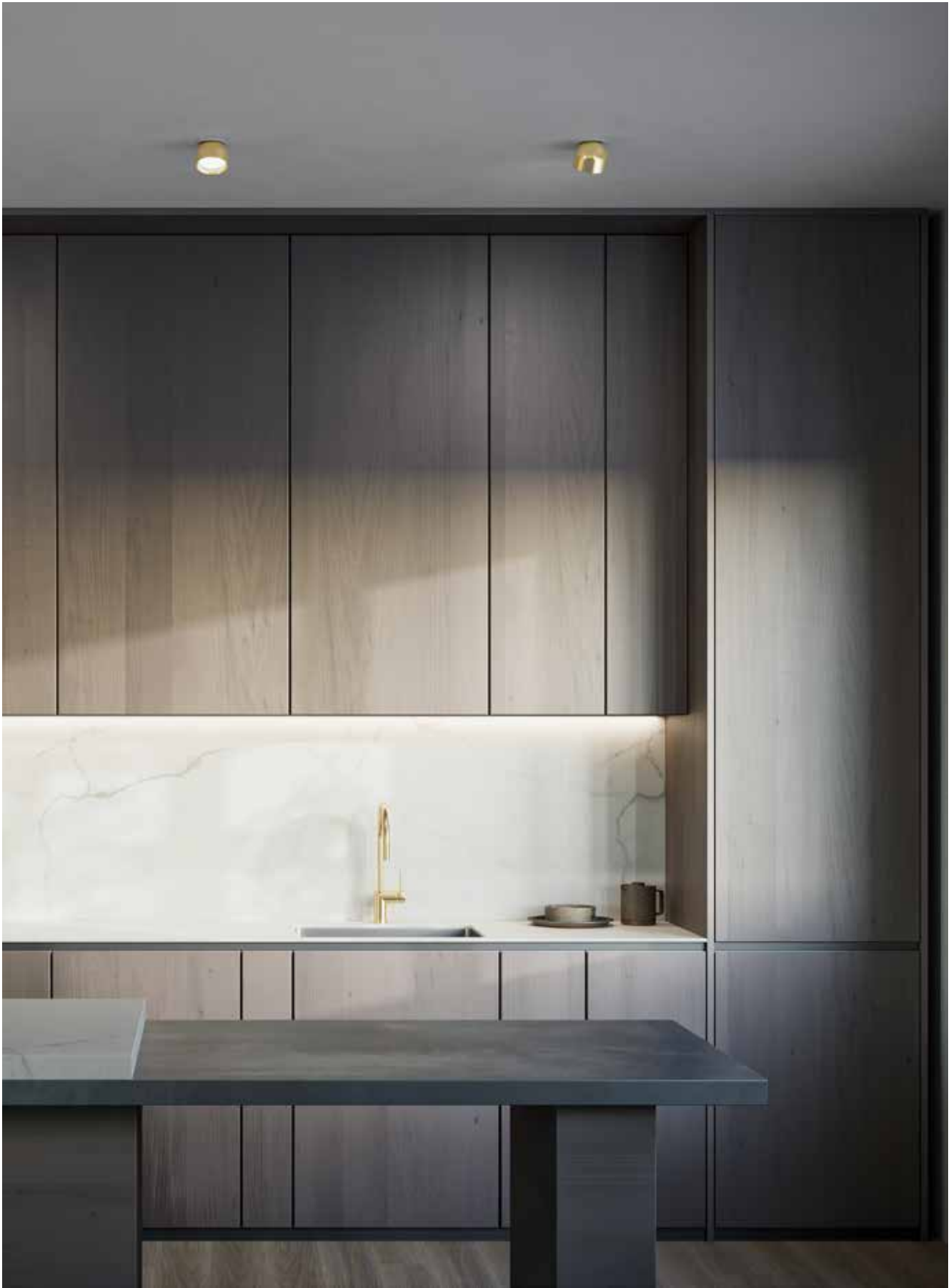

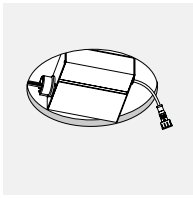

24

**INSTALLATION  
GUIDE**



28

**VERSA**  
RC-03/04/06-CC



32

**FACET**  
RGM2/4/6-CC



34

**RGR**  
RGR1/2/4/6-CC  
RGR2/4-HP  
RGR4/6SQ-CC



38

**NOTCH**  
DRR2/4/6-CC



40

**ETCH**  
DDP4-CC  
DDP6-CC



42

**INDIRECT**  
IND4/6



44

**PINPOINT SERIES**  
MSL1/2/4/5/10/56/106

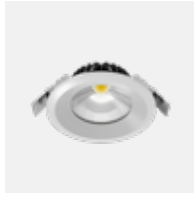

48

**HILUX**  
HPD4/6/8-CC

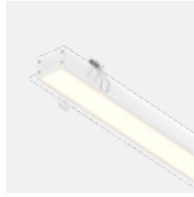

50

**BOULEVARD**  
LNR24/48-CC



52

**APERTURE**  
MFD03-CC

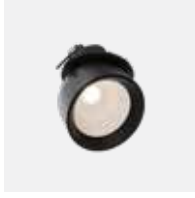

54

**HORUS**  
GSP3-CC



56

**REVOLVE**  
GBR35/04/06-CC  
GBR35/04/06-DW  
GBR35SQ-CC  
GBR35-CC-DUO  
GBR35-CC-TRIO

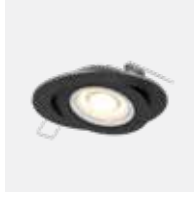

60

**PIVOT**  
FGM4-3K  
FGM2/3/4/6  
FGM4/6 SQ-CC  
FGM4-CC-DUO  
FGM4-CC-TRIO

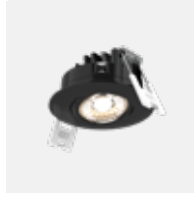

64

**SCOPE**  
LEDDOWNG3  
GMB2/4



66

**FUSION**  
GPN4-CC  
GPN6-CC



68

**MYSTIQUE**  
SPN4-CC  
SPN6-CC

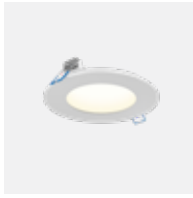

70

**EXCEL**  
5003/4/5/6-CC  
5004SQ-CC



72

**ACCESS**  
2003/2004/2006



74

**ALTER SERIES**  
RTJB4-3K  
RTJB3/4-CC

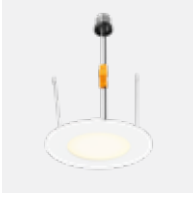











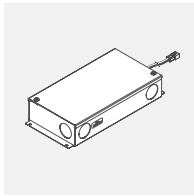
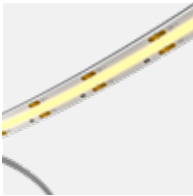
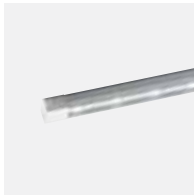

76

**ALTER SERIES**  
LEDPNLRTF56-CC

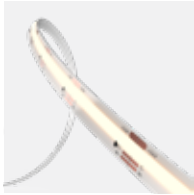

78

**ACCESSORIES**

12 V					
	<b>86</b> <b>INSTALLATION GUIDE</b>	<b>88</b> <b>COB-TAPE</b> COBTP3M/ COBTP5M/ COBTP-REEL	<b>90</b> <b>SWIVLED12</b> SWIVLED12-CC	<b>91</b> <b>SUPER-PUCK RECESSED</b> 4001-CC	<b>92</b> <b>DUO-PUCK</b> 4005-CC K4005-CC
					
	<b>93</b> <b>MINI-PUCK</b> LEDRDM1	<b>94</b> <b>ECO-PUCK</b> LEDRDP18	<b>95</b> <b>SLIDE</b> DD1260		
24 V					
<b>96</b> <b>COB-TAPE</b> COBTP24V-K10FT-CC COBTP24V-K20FT-CC COBTP24V-R50FT-CC COBTP24V-R100FT-CC					
120 V					
	<b>98</b> <b>POWERLED PUCK</b> 6001-CC	<b>99</b> <b>POWERLED LINEAR</b> 6009CC/ 6012CC/ 6024CC/ 6036CC/ 6048CC	<b>100</b> <b>PROLED LINEAR</b> HLF09/ HLF12/ HLF18/ HLF24/ HLF30	<b>102</b> <b>COUNTERLED LINEAR</b> 9009CC/ 9012CC/ 9018CC /9024CC/ 9030CC	
GENERAL					
	<b>104</b> <b>LED DIMMABLE DRIVERS</b>	<b>106</b> <b>ACCESSORIES</b>			





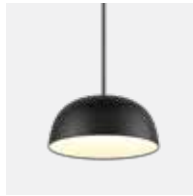

118  
NAPA  
NAPF20-CC



120  
IRIS  
IRPD-CC



122  
QUARTET  
CAPD72-CC



124  
BOULEVARD PENDANT  
LNPD48-CC  
LNPDSC48-CC



126  
PINPOINT  
MSLPD48-CC



128  
BEAM  
SPD48-CC  
SPD72-CC

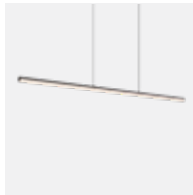

132  
CURRENT  
SLPD60-CC



134  
SWAY ONE  
W1PD48-CC



134  
SWAY THREE  
W3PD36-CC



136  
SPIN  
BRPD40-CC



136  
SPIN  
BRPD18-CC



138  
OLYMPIA FIVE  
RRPD5-CC



138  
OLYMPIA TWO  
RRPD2-CC



140  
HELIX  
SPR20-CC  
SPR34-CC



142  
TWIST  
TWPS-3K



144  
TWIRL  
TWPD-CC



146  
ATOM PENDANT  
FPD60-CC



146  
ATOM ONE  
FPD-CC



146  
ATOM THREE  
FPDC3-CC



148  
CIRCA  
RGPD24-CC

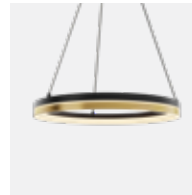

150  
ECLIPSE  
PDR14-CC

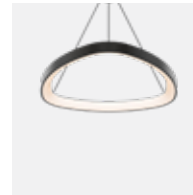

152  
PYRA  
TRPD34-CC



154  
DROP  
CFPD20-CC



158  
ASTERISK  
SSPD32-CC

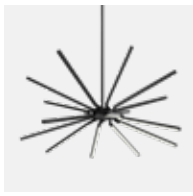

160  
STELLAR PENDANT  
STRPD-3K



164  
NOVA  
PDC18-CC

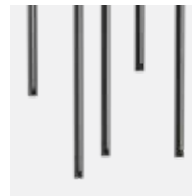

166  
CHANNEL PENDANT  
PDLED120-  
24/36 /48/60  
5/5SQ/8/8SQ



124  
BOULEVARD FLUSH  
MOUNT  
LNF48-CC



168  
FOCUS  
CYL05-CC  
CYL06-CC-V



118

**NAPA**  
NAPF20-CC



146

**ATOM**  
FDB-CC



158

**ASTERISK FLUSH MOUNT**  
SSF20-CC



160

**STELLAR FLUSH MOUNT**  
STRFM-3K



134

**SWAY FLUSH MOUNT**  
W3FM-CC



170

**HOVER**  
CCFM-CC



172

**NEWTON**  
FMT18-CC



152

**PYRA FLUSH MOUNT**  
TRFM22-CC



174

**MISTY**  
FUZ11-CC



176

**AURORA**  
CFH12-CC



178

**ORA**  
CFG13-C



180

**FUSION**  
TLFM12-CC  
TLFM21-CC



182

**DELTA**  
CFLEDR 6/10/14/18/24-CC  
CFLEDSQ6/10/14-CC



186

**RADIANCE**  
FMM09-CC  
FMM12-CC



188

**PRIME**  
FMP05-CC  
FMP05M-CC  
FMP09/12-CC



190

**SHIFT**  
VA032-CC  
VA024-CC



192

**LEDGE**  
VAL24-CC  
VAL36-CC

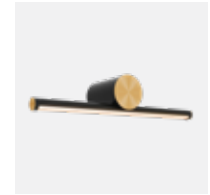

194

**BALANCE**  
VCC24-CC  
VCC36-CC



136

**SPIN SCONCE**  
BRV24-CC  
BRV36-CC

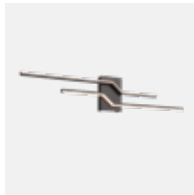

196

**LIGHTNING**  
VDL40-CC



198

**ARIA**  
VSW24-CC  
VSW36-CC



200

**NOBLE ONE**  
LEDVAN001-CC-18  
LEDVAN001-CC-24

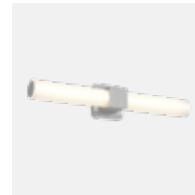

202

**NOBLE TWO**  
LEDVAN002-CC-24  
LEDVAN002-CC-36



204

**LYRA**  
LEDVAN003-CC-24  
LEDVAN003-CC-32



206

**PORTRAIT**  
VLG24-CC  
VLG36-CC

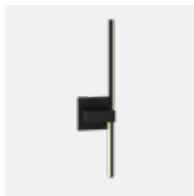

160

**STELLAR**  
STK21-CC  
STK37-CC

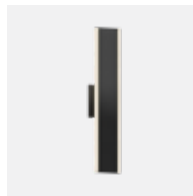

208

**GEMINI**  
SWS24-CC  
SWS36-CC  
SWS48-CC  
SWS60-CC

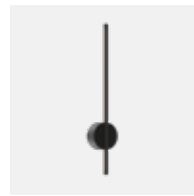

210

**MIDNIGHT**  
RWS24-CC  
RWS48-CC  
RWS60-CC



214

**PROFILE**  
LWJ08-CC  
LWJ16-CC  
LWJ24-CC

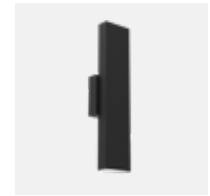

126

**PINPOINT WALL**  
MSLWALL-CC



216  
ADEN  
LEDWALL-A



218  
BROOKLYN  
LEDWALL-B



220  
EDINBURGH  
LEDWALL-E



222  
SHIELD  
DSWC05-CC  
DSWC07-CC-V



224  
GENEVA  
LEDWALL-G-CC



226  
HARLOW  
LEDWALL-H



228  
ALTO  
SQS06/10/15



230  
CUBIX  
LEDWALL001D



232  
RISE  
LSTP12-CC



228  
ALTO STEP LIGHT  
SQSTP-CC



234  
ECHO  
LEDSTEP002D-CC

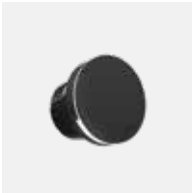

236  
PEARL  
LEDSTEP004D-CC



238  
CAMBER  
LEDSTEP005D-CC



240  
ASCEND  
LSTP07-CC



250  
GLAM  
RTL-3C



160  
STELLAR FLOOR  
STRFL-3K

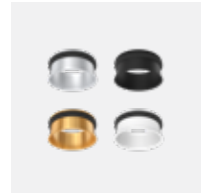

242  
ACCESSORIES



12 V

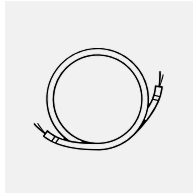

247

CONNECTION  
GUIDE



250

GLAM  
RTL-3C

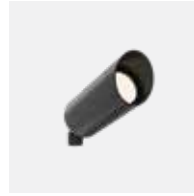

252

SLIM SPOT  
LSS10-CC

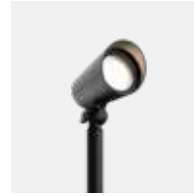

254

SPOT  
LSP3-CCL  
LSP4-CCL

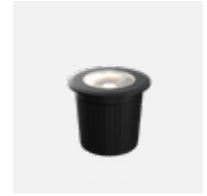

256

SOL  
GRD2-CC



258

EDGE  
LSQP-CC



260

FLUX  
LPP20-CC



262

COLUMN  
LRB20-CC  
LRB30-CC



264

CONTOUR  
LHS07-CC



266

TRANSFORMERS  
LTRP-60  
LTR-300

120 V



268

STATURE  
LEDPATH004D

GENERAL

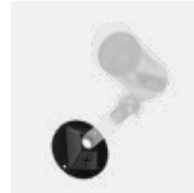

296

ACCESSORIES



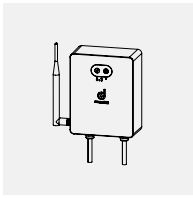

272

**SMART CONNECTION  
GUIDE**



276

**CORE**  
DCP-TR60, DCP-TR200,  
DCP-TR300

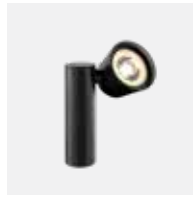

278

**ORBIT**  
DCP-SPT6



280

**GAÏA**  
DCP-CPL24

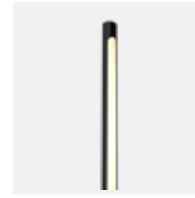

282

**AXIS**  
DCP-STK20  
DCP-STK50



284

**ACUTE**  
DCP-45HP20



286

**HORIZON**  
DCP-FLD30



288

**MASON**  
DCP-BRK12



290

**FLEX**  
DCP-NFTAP5M

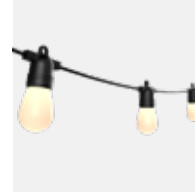

292

**ORION**  
DCP-STG48

24 V



294

**KAYU**  
DCP-RK10  
DCP-RK18



297

**ACCESSORIES**









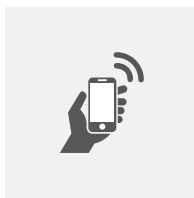

**301**  
**CONNECTION**  
**GUIDE**



**304**  
**PRO HUB**  
 DCP-HUB

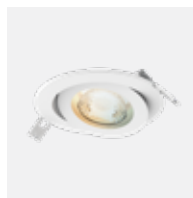

**306**  
**PIVOT PRO**  
 DCP-FGM4

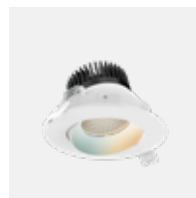

**308**  
**REVOLVE PRO**  
 DCP-GBR35

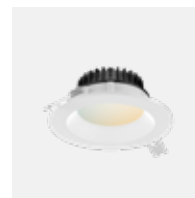

**310**  
**ETCH PRO**  
 DCP-DDP4  
 DCP-DDP6



**312**  
**EXCEL PRO**  
 DCP-PNL4  
 DCP-PNL6

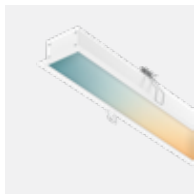

**314**  
**BOULEVARD PRO**  
 DCP-LNR24  
 DCP-LNR48



**316**  
**BOULEVARD**  
**PENDANT PRO**  
 DCP-LNPD48



**318**  
**FRAME**  
 DCP-CGWS

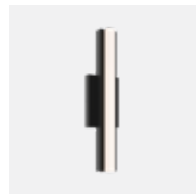

**320**  
**ARCHITECT**  
 DCP-LWS19



**322**  
**GLOW**  
 DCP-TAPXXFT



**324**  
**AXIS PRO**  
 SM-STTL20  
 SM-STFL50

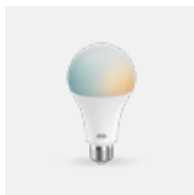

**326**  
**A21 PRO**  
 DCP-BLBA21

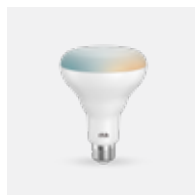

**328**  
**BR30 PRO**  
 DCP-BLBBR30



**330**  
**CLICC**  
 DCP-RMCT

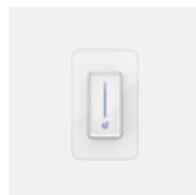

**332**  
**SMART DIMMER**  
**SWITCH**  
 SM-DIMSW



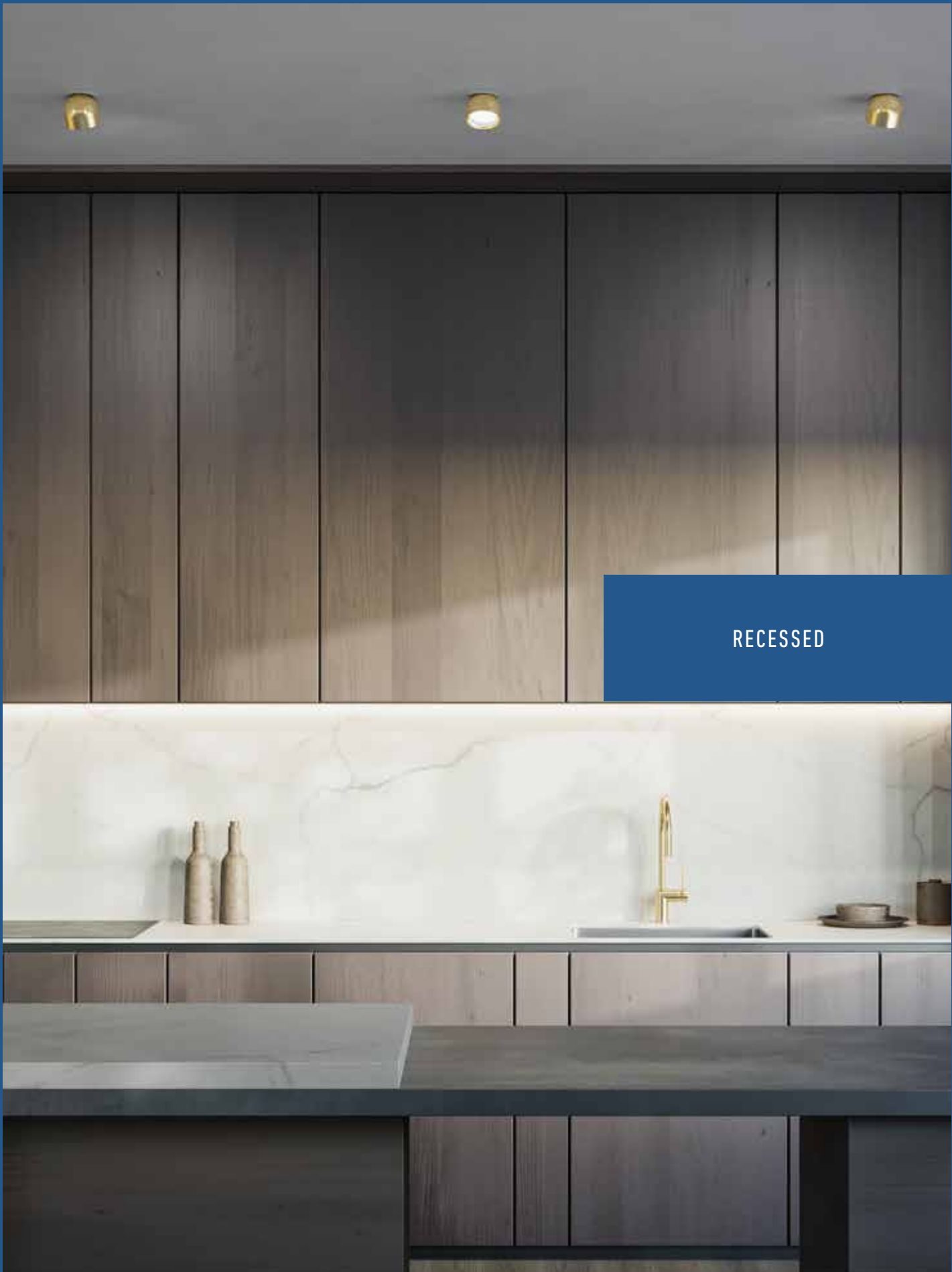

RECESSED

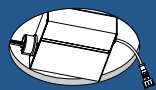

24  
**INSTALLATION  
GUIDE**



28  
**VERSA**  
RC-03/04/06-CC



32  
**FACET**  
RGM2/4/6-CC



34  
**RGR**  
RGR1/2/4/6-CC  
RGR2/4-HP  
RGR4/6SQ-CC



38  
**NOTCH**  
DRR2/4/6-CC



40  
**ETCH**  
DDP4-CC  
DDP6-CC



42  
**INDIRECT**  
IND4/6



44  
**PINPOINT SERIES**  
MSL1/2/4/5/10/5G/10G



48  
**HILUX**  
HPD4/6/8-CC



50  
**BOULEVARD**  
LNR24/48-CC



52  
**APERTURE**  
MFD03-CC



54  
**HORUS**  
GSP3-CC



56  
**REVOLVE**  
GBR35/04/06-CC  
GBR35/04/06-DW  
GBR35SQ-CC  
GBR35-CC-DUO  
GBR35-CC-TRIO



60  
**PIVOT**  
FGM4-3K  
FGM2/3/4/6  
FGM4/6 SQ-CC  
FGM4-CC-DUO  
FGM4-CC-TRIO



64  
**SCOPE**  
LEDDOWNG3  
GMB2/4



66  
**FUSION**  
GPN4-CC  
GPN6-CC



68  
**MYSTIQUE**  
SPN4-CC  
SPN6-CC



70  
**EXCEL**  
5003/4/5/6-CC  
5004SQ-CC



72  
**ACCESS**  
2003/2004/2006



74  
**ALTER SERIES**  
RTJB4-3K  
RTJB3/4-CC



76  
**ALTER SERIES**  
LEDPNLRTF56-CC



78  
**ACCESSORIES**



# Proper Sizing, Spacing and Downlighting Techniques

**The components** Our recessed kits include two main components: the driver and the fixture.

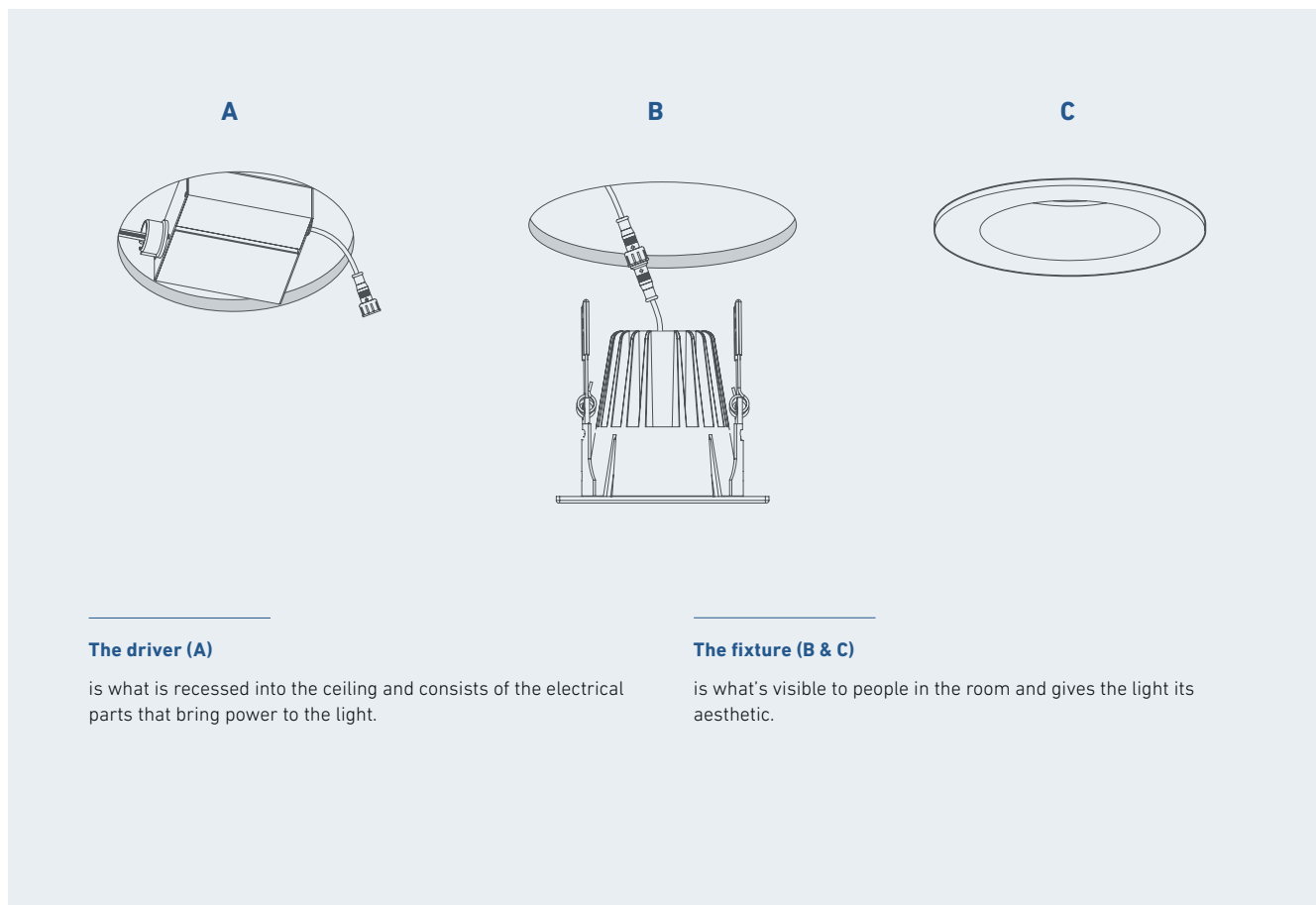

**The driver (A)**

is what is recessed into the ceiling and consists of the electrical parts that bring power to the light.

**The fixture (B & C)**

is what's visible to people in the room and gives the light its aesthetic.



Fixtures and drivers are sized to correlate with one another and are sold together with all of our recessed lights.



Panels, spotlights, downlights—whatever you call them, recessed lights are among the most versatile lighting options available. The most common use of recessed lighting, and what we'll focus on here, is recessed downlighting from the ceiling.



Most of our recessed fixtures are available with either a 120V driver or an optional multi-voltage driver (120V / 277V / 347V), ensuring compatibility with various electrical setups. They support 0-10V dimming, enabling seamless lighting control in different settings. Look for this symbol throughout the catalog to easily identify these versatile fixtures.

## Installation type

What fixture you choose starts with knowing whether it will be used in a new construction, a remodel or as a retrofit.

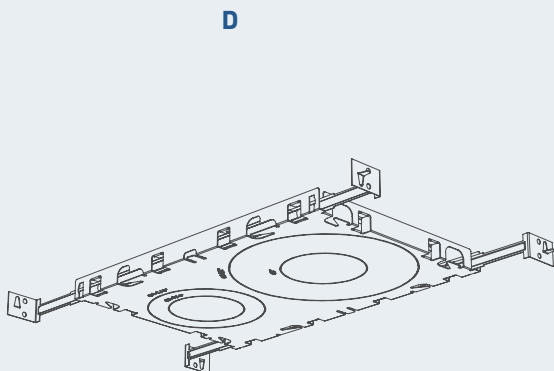

### New construction

Locations with visible ceiling joists and without drywall. Lights can be used with our rough-in plates (**D**) to help in the installation process.

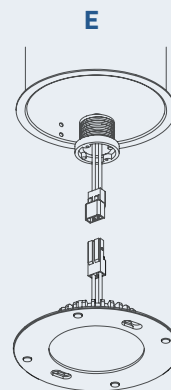

### Remodels

When the joists are not exposed or if you want to upgrade your current system to LED.

### Retrofit

When an existing bulb is removed from the original housing, and replaced with an LED trim (**E**).



Most of Dals' recessed fixtures are designed for new construction and remodels. These fixtures are installed through a small opening in the ceiling and held in place with clips.



A rough-in plate is designed for new construction or renovations where the ceiling framing is exposed. It allows for proper placement of your recessed light and is made from sturdy galvanized steel.

## How many downlights do I need?

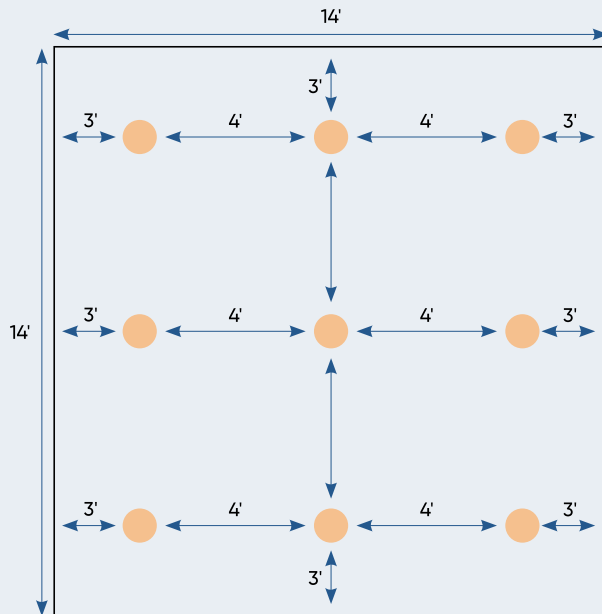

**A simple method for estimating the number of downlights required is as follows:**

Recessed downlights are generally positioned 2 to 3 feet away from walls with a space of 3 to 4 feet between each light.

Dividing the ceiling height by two is a way of gauging how much space to leave between each downlight.

**Thus, if your ceiling is 8 foot high, place your lights 4 feet apart.**



In Canada, 4" recessed lights are the most popular, in the U.S., 6" are most commonly used.





NEW

# VERSA

A versatile recessed lighting solution available in three-, four-, and six-inch sizes, featuring customizable finishes, trims, lenses, and reflectors, with options for standard, sloped ceiling, and trimless installations, all with multi-voltage compatibility. Perfect for commercial or residential spaces.

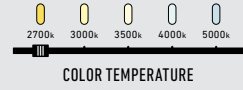

MULTI-WATTAGE



WET



LOW-GLARE



CUSTOMIZE



T24  
JA8  
CERTIFIED



RC04-CC



**DRIVER**  
Converts mains voltage (120V/277V/347V) to the appropriate current for the LEDs, featuring multiple dimming capabilities, including Triac and 0-10V dimming, for added flexibility..

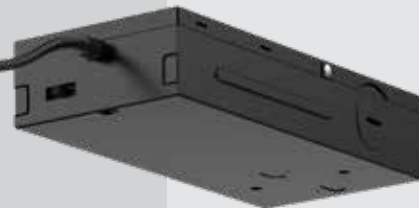

**LIGHT ENGINE**

Includes an LED module, a heatsink for efficient cooling, a lens holder for light distribution, and a rotating dial at the top to select the color temperature.



**LENS**

Sits below the light engine and shapes the light to create the desired beam angle. Available in 20°, 35°, and 60° angles.



**REFLECTOR**

Sits inside the trim, with options for sloped or regular ceiling positioning. Available in four finishes: Alzak, black, gold, and white.



**TRIM**

The visible part framing the light opening. Flanged trim has a visible edge (available in black, gold, and white), while trimless blends seamlessly with the ceiling.



**RC03-CC**

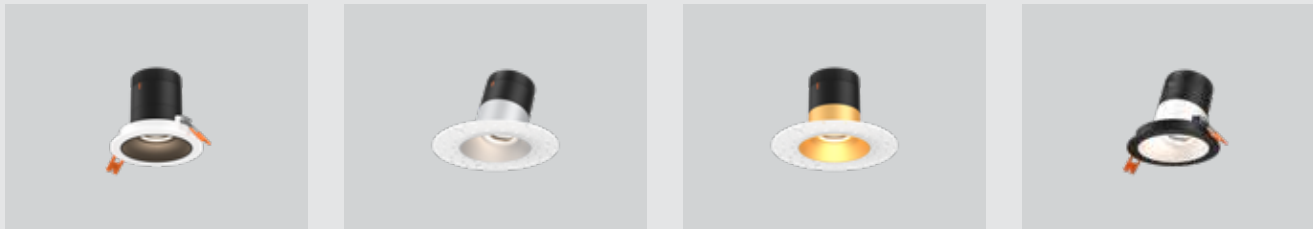

**RC04-CC**

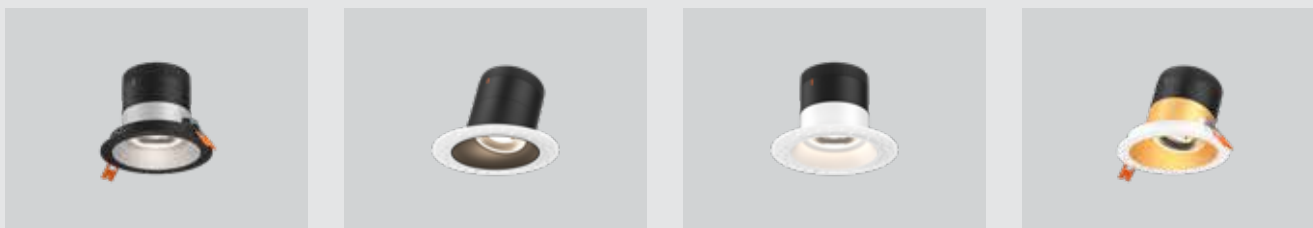

**RC06-CC**

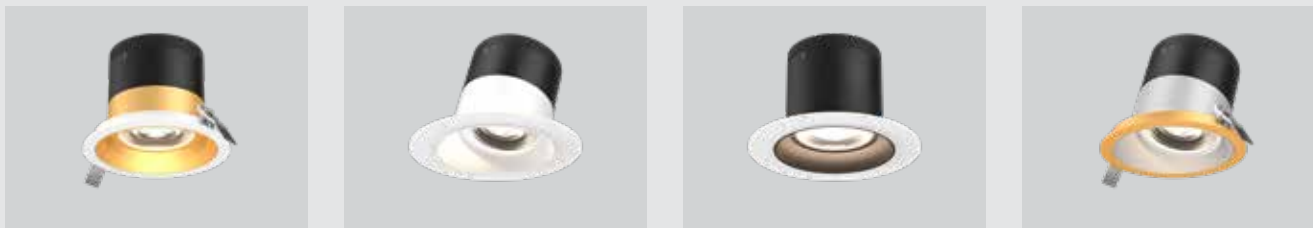

**ORDERING GUIDE**

Prefix	Light module	Beam angle	Reflector type	Reflector finish	Trim style
<b>RC</b>	<b>03-CC</b> 3" module/1000lm	<b>20</b> 20° narrow beam	<b>RG</b> Regular ceiling	<b>AZ</b> Alzac	<b>TL</b> Round trimless
	<b>04-CC</b> 4" module/2000lm	<b>35</b> 35° medium beam	<b>SL</b> Sloped ceiling	<b>BK</b> Black	<b>TBK</b> Round black trim
	<b>06-CC</b> 6" module/3000lm	<b>60</b> 60° wide beam		<b>GD</b> Gold	<b>TGD</b> Round gold trim
				<b>WH</b> White	<b>TWH</b> Round white trim

**RC 04-CC - 20 - RG BK - TBK**

**RC04-CC-20-RGBK-TBK**

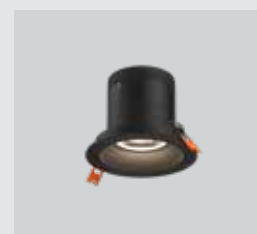

NEW

# VERSA

A versatile recessed lighting solution available in three-, four-, and six-inch sizes, featuring customizable finishes, trims, lenses, and reflectors, with options for standard, sloped ceiling, and trimless installations, all with multi-voltage compatibility. Perfect for commercial or residential spaces.

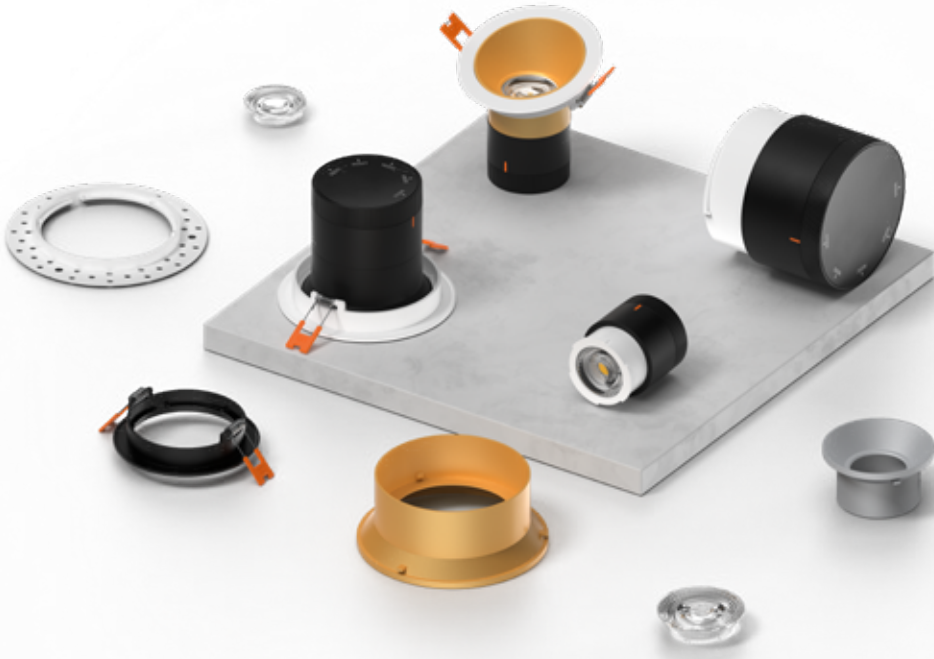

COLOR TEMPERATURE



MULTI-WATTAGE



WET



LOW-GLARE



CUSTOMIZE



IC RATED

T24 JAB CERTIFIED



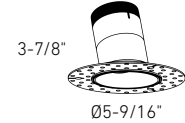
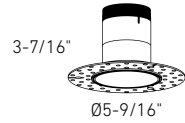
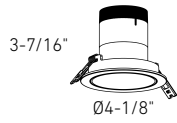

Model	Size	Watts	Delivered lumens	CRI	Color °T	Voltage ⚡
RC03-CC	3"	8/10/12 W	1000 lm	90	2700, 3000, 3500, 4000, 5000 K	120 / 277 / 347V Triac and 0-10V dimming
RC04-CC	4"	16/20/24 W	2200 lm			
RC06-CC	6"	24/30/36 W	3000 lm			

---

**RC03-CC**Ø3-1/2" 

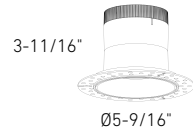
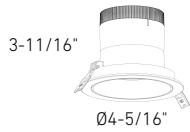
---

**RC04-CC**Ø4-1/4" 

---

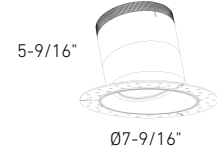
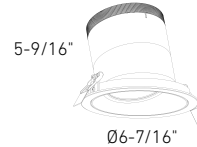
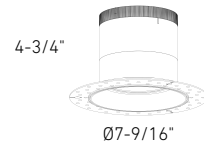
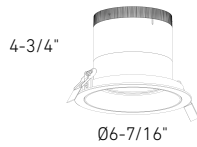
**RC06-CC**Ø6" 

---

**Specifications**

Every fixture includes a junction box with integrated dimmable driver  
Multi-watt output allows you to choose from three wattage settings for customizable brightness directly on the jbox  
Can be daisy chained  
Aluminum construction  
Rotary dial CCT switch  
20°, 35°, or 60° beam angles  
5-year warranty

---

**Accessories**

**RFP-35**  
Rough-in plate for 3" model  
**RFP-46**  
Rough-in plate for 4" models  
**RFP-RC06**  
Rough-in plate for 6" models  
**REC-CC-EXT8FT**  
8-foot extension cable  
**REC-CC-EXT20FT**  
20-foot extension cable

---

**Note**

Other color temperatures, finishes, and voltage options are available but may require minimum order quantities (MOQs) and longer lead times. Please contact your DALI representative for more information.

# FACET

This versatile modern thin-trim 2, 4 and 6-inch gimbal with multi-directional adjustable swivel produces a bright glow with minimal glare as a result of its regressed light source. Ideal for general lighting or for areas requiring a directional light to showcase unique elements or to create dramatic wall-wash effects.



COLOR TEMPERATURE



Model	Size	Watts	Delivered lumens	CRI	Color °T	Voltage options ⚡
RGM2-CC	2"	8 W	660 lm	90	2700, 3000, 3500, 4000, 5000 K	<b>120V TRIAC dimming</b>
RGM4-CC	4"	12 W	1200 lm			or
RGM6-CC	6"	20 W	1500 lm			<b>V: 120 / 277 / 347V 0-10V dimming</b> (Check for availability)

\*Model RGM4-CC only

**RGM2-CC**

Ø2-3/4"

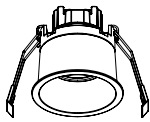

3"

Ø3-1/8"

**RGM4-CC**

Ø4-1/4"

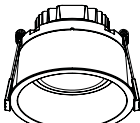

3-1/2"

Ø4-1/2"

**RGM6-CC**

Ø6-1/2"

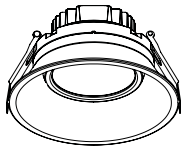

3-1/2"

Ø6-3/4"



### Specifications

Every fixture includes a junction box with integrated dimmable driver

Can be daisy chained

Aluminum construction

Switch-selectable CCT

40° beam angle

30° tilting, 360° rotation

5-year warranty

### Finish

● **BK** Black

○ **WH** White

### Accessories

#### **RFP-UNI**

Universal rough-in plate

#### **RFP-23**

Rough-in plate for 2" model

#### **RFP-46**

Rough-in plate for 4" and 6" models

#### **REC-CC-EXT8FT**

8-foot extension cable

#### **REC-CC-EXT20FT**

20-foot extension cable

### Multi-voltage (V) ⚡

This product family offers multi-voltage drivers (120/277/347) that are dimmable using 0-10V dimming systems. Please note that longer lead times may apply for this option. Kindly reach out to your DALI representative for additional information and to confirm availability.

### Note

Other color temperatures, finishes, and voltage options are available but may require minimum order quantities (MOQs) and longer lead times. Please contact your DALI representative for more information.

# RGR

When choosing a recessed fixture, eliminating glare is a priority. The unique positioning of the LED module in this series of downlights will meet that important need.

RGR6-CC



RGR1-CC



RGR2-CC



RGR4-CC







COLOR TEMPERATURE



**IC**  
RATED

**T24**  
**JA8**  
CERTIFIED



RGR6SQ-CC



RGR2SQ-CC



RGR4SQ-CC



# RGR

When choosing a recessed fixture, eliminating glare is a priority. The unique positioning of the LED module in this series of downlights will meet that important need.

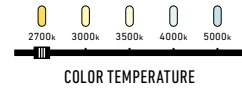

Model	Size	Watts	Delivered lumens	CRI	Color °T	Voltage options ⚡
RGR1-CC	1"	6 W	450 lm	90	2700, 3000, 3500, 4000, 5000 K	<b>120V TRIAC dimming</b>
RGR2-CC	2"	8 W	600 lm			or
RGR2HP-CC	2"	15 W	1080 lm			
RGR2SQ-CC	2"	8 W	600 lm			<b>V: 120 / 277 / 347V 0-10V dimming</b> (Check for availability)
RGR4-CC	4"	14 W	1100 lm			
RGR4HP-CC	4"	20 W	1560 lm			
RGR4SQ-CC	4"	15 W	1100 lm			
RGR6-CC	6"	20 W	1600 lm			
RGR6SQ-CC	6"	20 W	1600 lm			

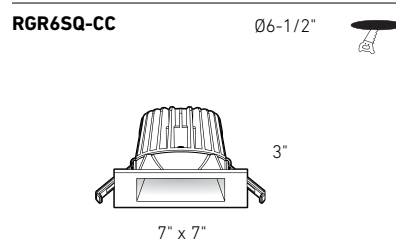
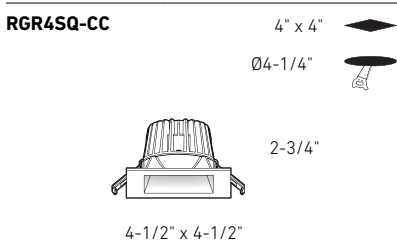
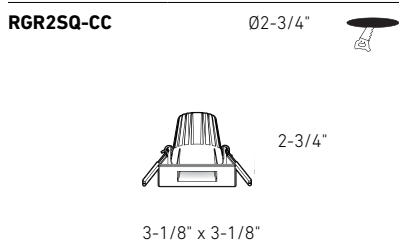
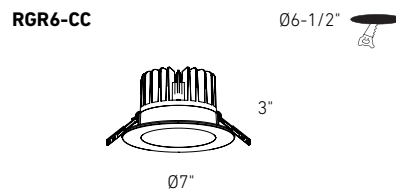
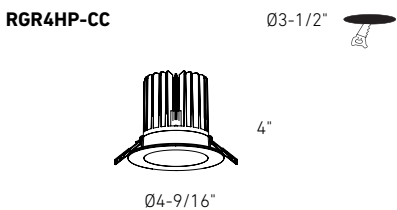
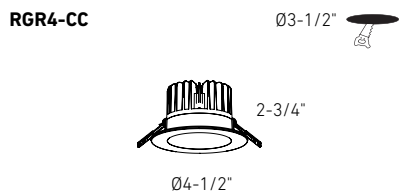
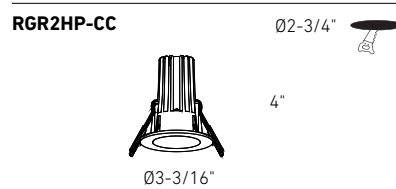
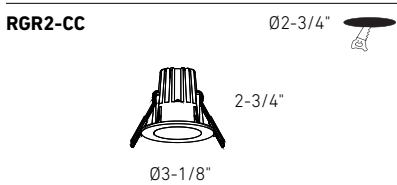
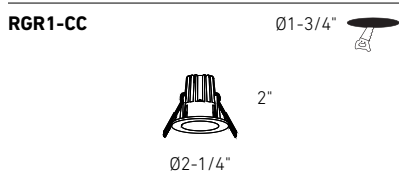

### Specifications

Every fixture includes a junction box with integrated dimmable driver  
 Can be daisy chained (4" and 6" models only)  
 Aluminum construction  
 Switch-selectable CCT  
 40° beam angle  
 5-year warranty

### Finish

- **BK** Black
- **SN** Satin Nickel
- **WH** White

### Accessories

- RFP-01**  
Rough-in plate for RGR1
- RFP-23**  
Rough-in plate for RGR2, RGR2HP, RGR2SQ
- RFP-35**  
Rough-in plate for RGR4, RGR4HP
- RFP-46**  
Rough-in plate for RGR6, RGR4SQ & RGR6SQ
- RFP-UNI**  
Universal rough-in plate for RGR2, RGR2HP, RGR2SQ, RGR4HP, RGR4SQ, RGR6, RGR6SQ
- REC-CC-EXT8FT**  
8-foot extension cable
- REC-CC-EXT20FT**  
20-foot extension cable

### Multi-voltage (V) ⚡

This product family offers multi-voltage drivers (120/277/347) that are dimmable using 0-10V dimming systems. Please note that longer lead times may apply for this option. Kindly reach out to your DALI representative for additional information and to confirm availability.

### Note

Other color temperatures, finishes, and voltage options are available but may require minimum order quantities (MOQs) and longer lead times. Please contact your DALI representative for more information.

# NOTCH

The Notch series of recessed downlights is characterized by a deep-set LED position which greatly reduces glare, neatly packaged in a price-conscious solution to general lighting.

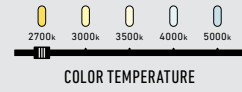

Model	Size	Watts	Delivered lumens	CRI	Color °T	Voltage options ⚡
DRR2-CC	2"	9 W	500 lm	90	2700, 3000, 3500, 4000, 5000 K	<b>120V TRIAC dimming</b>
DRR4-CC	4"	11 W	800 lm			or
DRR6-CC	6"	14 W	1000 lm			<b>V: 120 / 277 / 347V 0-10V dimming</b> (Check for availability)

**DRR2-CC**

Ø2-3/4"

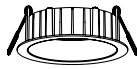

1-7/8"

Ø3-1/8"

**DRR4-CC**

Ø4-1/4"



1-13/16"

Ø4-3/4"

**DRR6-CC**

Ø6-1/2"



1-13/16"

Ø6-7/8"



### Specifications

Every fixture includes a junction box with an integrated driver

Can be daisy chained

Smooth 360° wide spread

100° beam angle

Frosted lens

Edge lit technology

Switch-selectable CCT

5-year warranty

### Finish

○ **WH** White

### Accessories

#### **RFP-23**

Rough-in plate (DRR2)

#### **RFP-46**

Rough-in plate (DRR4, DRR6)

#### **RFP-UNI**

Universal rough-in plate (DRR4, DRR6)

#### **DRR4-TRIM-BK**

4" recessed panel trim in black

#### **DRR4-TRIM-SBA**

4" recessed panel trim in sandblasted aluminum

#### **DRR6-TRIM-BK**

6" recessed panel trim in black

#### **DRR6-TRIM-SBA**

6" recessed panel trim in sandblasted aluminum

#### **REC-CC-EXT8FT**

8-foot extension cable

#### **REC-CC-EXT20FT**

20-foot extension cable

### Multi-voltage (V) ⚡

This product family offers multi-voltage drivers (120/277/347) that are dimmable using 0-10V dimming systems. Please note that longer lead times may apply for this option. Kindly reach out to your DALI representative for additional information and to confirm availability.

### Note

Other color temperatures, finishes, and voltage options are available but may require minimum order quantities (MOQs) and longer lead times. Please contact your DALI representative for more information.

# ETCH

The Etch range of circular recessed downlights, characterized by a deep-set LED position, provides a functional solution to general lighting without the uncomfortable glare.

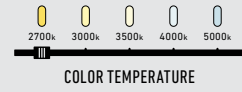

Model	Size	Watts	Delivered lumens	CRI	Color °T	Voltage options ⚡
DDP4-CC	4"	15 W	1000 lm	90	2700, 3000, 3500, 4000, 5000 K	<b>120V TRIAC dimming</b>
DDP6-CC	6"	20 W	1500 lm			

or

**V: 120 / 277 / 347V**  
**0-10V dimming**  
 (Check for availability)

**DDP4-CC**

Ø4-1/4"



**DDP6-CC**

Ø6-1/2"

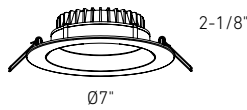

### Specifications

Every fixture includes a junction box with an integrated driver  
Can be daisy chained  
Smooth 360° wide spread  
125° beam angle  
Frosted lens  
Edge lit technology  
Cast aluminum construction  
Switch-selectable CCT  
5-year warranty

### Finish

**WH** White

### Accessories

**RFP-46**

Rough-in plate

**RFP-UNI**

Universal rough-in plate

**DDP4-TRIM-BK**

4" recessed panel trim in black

**DDP6-TRIM-BK**

6" recessed panel trim in black

**REC-CC-EXT8FT**

8-foot extension cable

**REC-CC-EXT20FT**

20-foot extension cable

### Multi-voltage (V) ⚡

This product family offers multi-voltage drivers (120/277/347) that are dimmable using 0-10V dimming systems. Please note that longer lead times may apply for this option. Kindly reach out to your DALs representative for additional information and to confirm availability.

### Note

Other color temperatures, finishes, and voltage options are available but may require minimum order quantities (MOQs) and longer lead times. Please contact your DALs representative for more information.

# INDIRECT

Imagine being able to create the perfect mood when dimming your lights. This is now possible with our Dim to Warm concept, generating a warm, exquisite glow to set the tone for your evening.



IND4-DW

IND6-DW

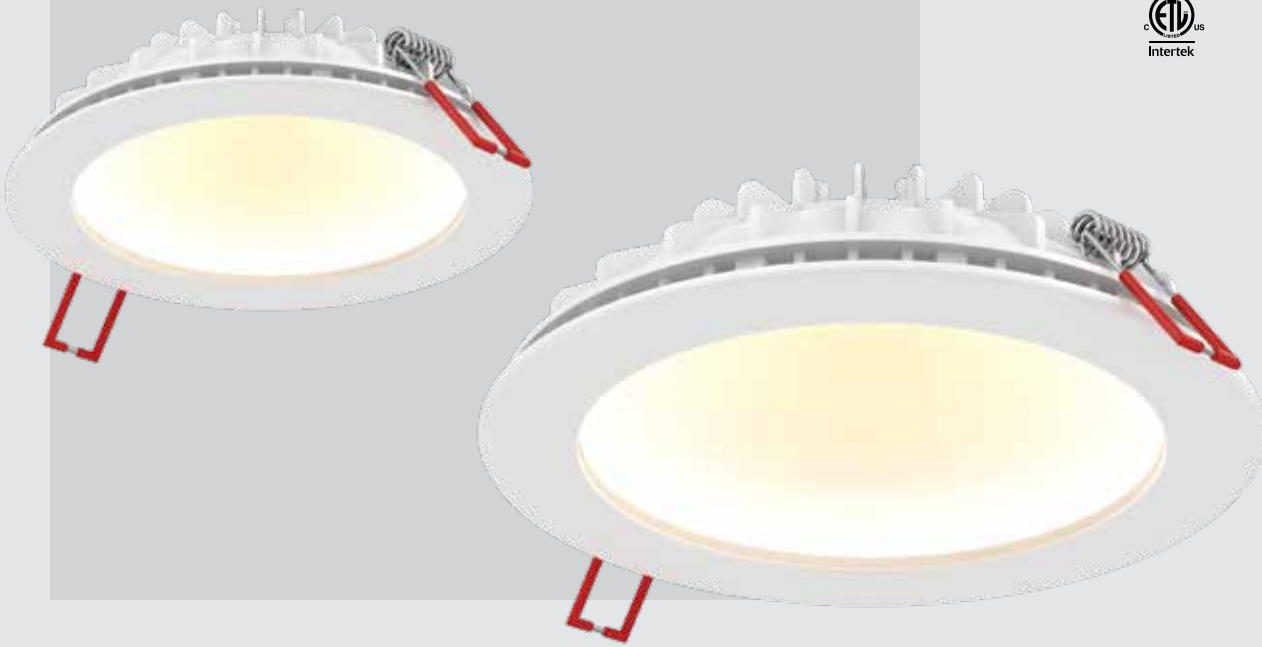

Model	Size	Watts	Delivered lumens	CRI	Color °T	Voltage
IND4-DW	4"	9 W	500 lm	80	3000 K - 2200 K	120 V
IND6-DW	6"	12 W	750 lm			



**IND4-DW**

Ø4-3/8"

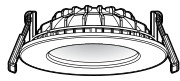

1-1/2"

Ø4-1/4"

**IND6-DW**

Ø6-1/4"

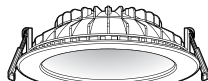

2"

Ø7-1/8"



### Specifications

Every fixture includes a junction box with integrated dimmable driver

Can be daisy chained

Dim-to-warm technology, dims from 3000 K to 2200 K to mimic incandescent light

Smooth 360° wide spread

Dome reflector

110° beam spread

Indirect lighting design with glare reduction

Aluminum construction

5-year warranty

### Finish

○ **WH** White

### Accessories

**RFP-UNI**

Universal rough-in plate

**RFP-46**

Rough-in plate for 4" and 6" models

**REC-3K-EXT8FT**

8-foot extension cable

**REC-3K-EXT20FT**

20-foot extension cable

### Note

Other color temperatures, finishes, and voltage options are available but may require minimum order quantities (MOQs) and longer lead times. Please contact your DALs representative for more information.

# PINPOINT

This series provides a contemporary aesthetic and functional design to your space. Available in various styles, and framed by a powder-coat finish, these high-output fixtures deliver crisp, low-glare light.

**MSL1**



**MSL5**



**MSL2**



**MSL5G**



**MSL4**



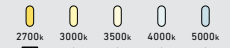

COLOR TEMPERATURE



MSL10



MSL10G



\*Models MSL5G-CC and MSL10G-CC only

# PINPOINT

This series provides a contemporary aesthetic and functional design to your space. Available in various styles, and framed by a powder-coat finish, these high-output fixtures deliver crisp, low-glare light.

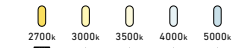

COLOR TEMPERATURE



DRY



LOW-GLARE



SWIVEL/DIRECTIONAL\*

**IC**

RATED



Intertek

Model	Size	Watts	Delivered lumens	CRI	Color °T	Voltage options ⚡
<b>MSL1-CC*</b>	1-15/16"	3 W	120 lm	90	2700, 3000, 3500, 4000, 5000 K	<b>120V TRIAC dimming</b>
<b>MSL2-CC</b>	3-1/8"	6 W	320 lm			or
<b>MSL4-CC</b>	3-1/8"	12 W	600 lm			
<b>MSL5-CC</b>	6"	14 W	800 lm			<b>V: 120 / 277 / 347V</b>
<b>MSL5G-CC</b>	6-3/4"	14 W	800 lm			<b>0-10V dimming</b>
<b>MSL10-CC</b>	11-5/8"	24 W	1300 lm			(Check for availability)
<b>MSL10G-CC</b>	11-15/16"	24 W	1300 lm			

\*MSL1-CC is available with standard 120V voltage only

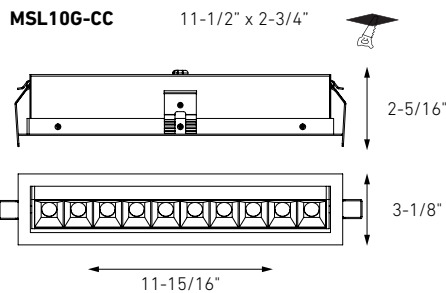
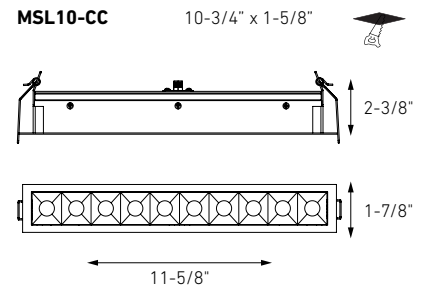
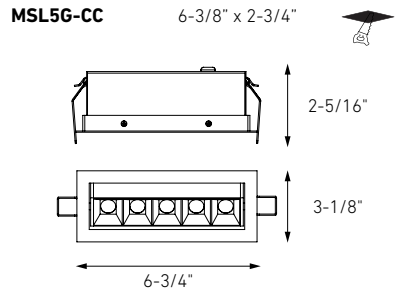
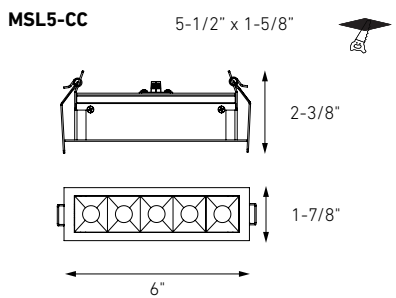
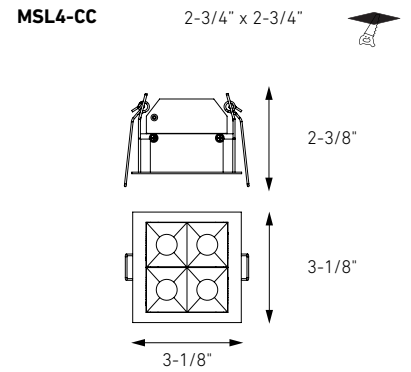
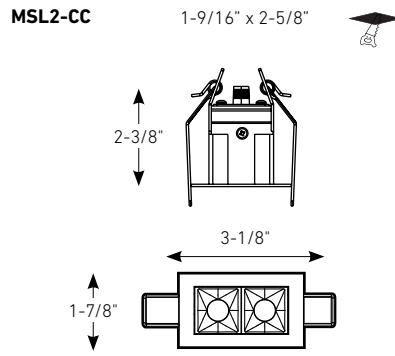
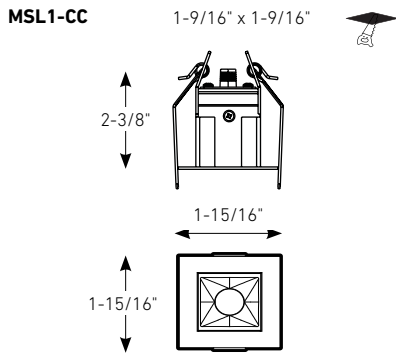

### Specifications

Every fixture includes a junction box with integrated dimmable driver  
 Switch-selectable CCT  
 Can be daisy chained  
 Aluminum construction  
 30 degree swivel (models MSL5G and MSL10G only)  
 Low-glare  
 5-year warranty

### Accessories

- RFP-MSL1**  
Rough-in plate for MSL1
- RFP-MSL2**  
Rough-in plate for MSL2
- RFP-MSL4**  
Rough-in plate for MSL4
- RFP-MSL5**  
Rough-in plate for MSL5
- RFP-MSL5G**  
Rough-in plate for MSL5G
- RFP-MSL10**  
Rough-in plate for MSL10
- RFP-MSL10G**  
Rough-in plate for MSL10G
- REC-CC-EXT8FT**  
8-foot extension cable
- REC-CC-EXT20FT**  
20-foot extension cable

### Finish

- BK** Black
- WH** White

### Multi-voltage (V) ⚡

This product family offers multi-voltage drivers (120/277/347) that are dimmable using 0-10V dimming systems. Please note that longer lead times may apply for this option. Kindly reach out to your DALI representative for additional information and to confirm availability.

### Note

Other color temperatures, finishes, and voltage options are available but may require minimum order quantities (MOQs) and longer lead times. Please contact your DALI representative for more information.

# HILUX

Dals' high-powered recessed downlight is a go-to for your commercial projects. With its five color temperatures to choose from, a cast aluminum housing, high lumen output, and indoor/outdoor rating, this can be installed just about anywhere. From clinics to schools and hotels to boutiques, this is the only recessed fixture you will need.

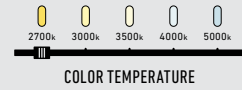

- WET
- LOW-GLARE
- AIR TIGHT
- IC**  
RATED
- T24**  
**JA8**  
CERTIFIED
- Intertek

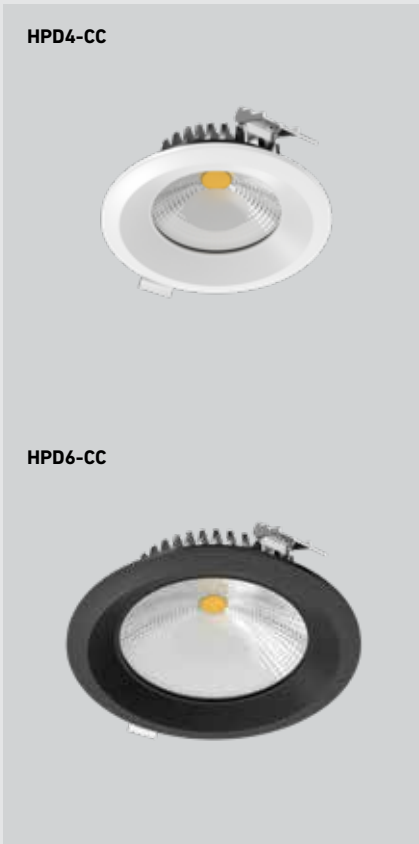

Model	Size	Watts	Delivered lumens	CRI	Color °T	Voltage options ⚡
HPD4-CC	4"	20 W	1415 lm	90	2700, 3000, 3500, 4000, 5000 K	<b>120V TRIAC dimming</b>
HPD6-CC	6"	30 W	2100 lm			or
HPD8-CC	8"	40 W	2600 lm			<b>V: 120 / 277 / 347V 0-10V dimming</b> (Check for availability)

**HPD4-CC**Ø4-1/4" 



2-1/8"

Ø5"

**HPD6-CC**Ø6-1/2" 

2-1/2"

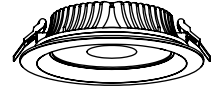
Ø7-1/4"

**HPD8-CC**Ø7-1/2" 

2-1/2"

Ø8-3/4"

**Specifications**

Every fixture includes a junction box with an integrated driver  
 Switch-selectable CCT  
 Smooth 360° wide spread  
 90° beam angle  
 Cast aluminum construction  
 5-year warranty

**Finish**

- **BK** Black (HPD4 and HPD6 only)
- **WH** White

**Accessories**

- RFP-46**  
Rough-in plate for HPD4, HPD6
- RFP-58**  
Rough-in plate for HPD8
- RFP-UNI**  
Universal rough-in plate
- REC-CC-EXT8FT**  
8-foot extension cable
- REC-CC-EXT20FT**  
20-foot extension cable

**Multi-voltage (V) ⚡**

This product family offers multi-voltage drivers (120/277/347) that are dimmable using 0-10V dimming systems. Please note that longer lead times may apply for this option. Kindly reach out to your DALSS representative for additional information and to confirm availability.

**Note**

Other color temperatures, finishes, and voltage options are available but may require minimum order quantities (MOQs) and longer lead times. Please contact your DALSS representative for more information.

# BOULEVARD

The Boulevard series, an architectural recessed lighting channel that can be installed in a wide range of commercial and residential environments. Add depth to ceiling planes with a visible separation, or seamlessly daisy-chained to create dramatic effects.

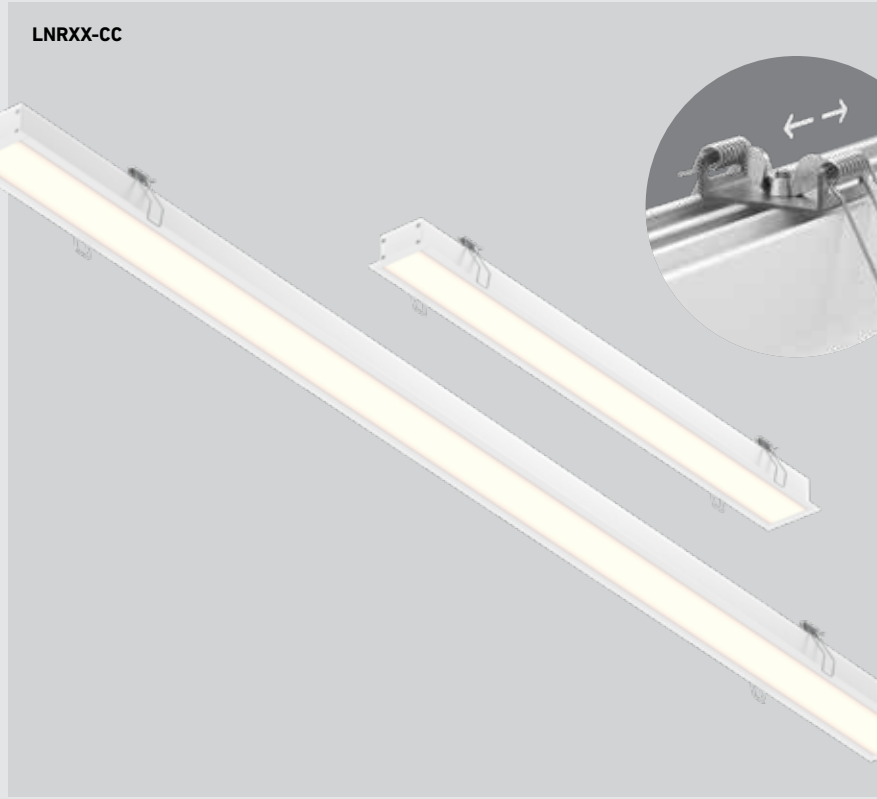
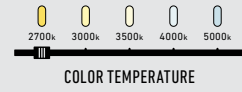

Model	Size	Watts	Delivered lumens	CRI	Color °T	Voltage options ⚡
LNR24-CC	24"	20 W	1725 lm	90	2700, 3000, 3500, 4000, 5000 K	<b>120V TRIAC dimming</b>
LNR48-CC	48"	40 W	3760 lm			

or

**V: 120 / 277 / 347V**  
**0-10V dimming**  
 (Check for availability)



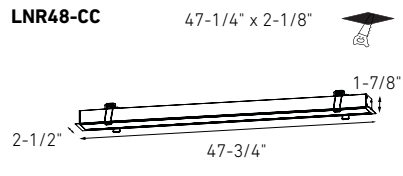
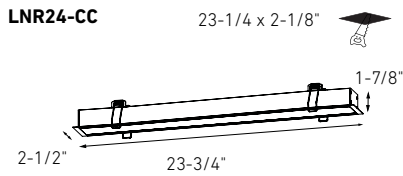

**More from this family**



**LNP48-CC**  
pg. 124



**LNP48-CC**  
pg. 124



**LNF48-CC**  
pg. 124

**Specifications**

- Every fixture includes a junction box with integrated dimmable driver
- Can be daisy chained
- Aluminum construction
- Switch-selectable CCT
- 108° beam spread
- 5-year warranty

**Finish**

- **BK** Black
- **WH** White

**Accessories**

- LNACC-L16FT**  
16-foot lens for Boulevard series pendants and recessed linears
- RFP-LNR24**  
Rough-in plate for LNR24
- RFP-LNR48**  
Rough-in plate for LNR48
- REC-CC-EXT8FT**  
8-foot extension cable
- REC-CC-EXT20FT**  
20-foot extension cable

**Multi-voltage (V) ⚡**

This product family offers multi-voltage drivers (120/277/347) that are dimmable using 0-10V dimming systems. Please note that longer lead times may apply for this option. Kindly reach out to your DALI representative for additional information and to confirm availability.

**Note**

Other color temperatures, finishes, and voltage options are available but may require minimum order quantities (MOQs) and longer lead times. Please contact your DALI representative for more information.

NEW

# APERTURE

Ideal for residential spaces, art galleries, or boutiques, our multi-function downlight offers versatile performance. It transitions seamlessly between recessed and spotlight modes, allows beam angle adjustments, tilts 90 degrees, and features multi-wattage settings to adapt to various lighting needs.



COLOR TEMPERATURE



MULTI-WATTAGE



AIR TIGHT



RATED



CERTIFIED



Model	Size	Watts	Delivered lumens	CRI	Color °T	Voltage options ⚡
MFD03-MW-CC	3"	8, 10, 12 W	600, 800, 1000 lm	90	2700, 3000, 3500, 4000, 5000 K	<b>120 V TRIAC dimming</b>  or  <b>V: 120 / 277 / 347V 0-10V dimming</b> (Check for availability)

MFD03-CC

Ø3-3/8" 

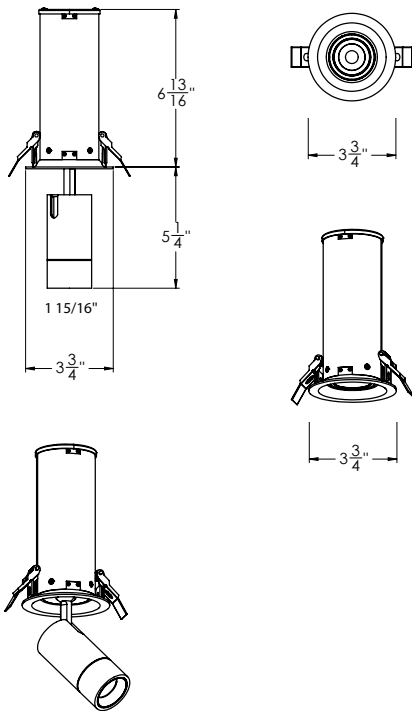

### Specifications

Every fixture includes a junction box with integrated dimmable driver  
Switch-selectable CCT  
Multi-watt output allows you to choose from three wattage settings for customizable brightness directly on the jbox  
Can be daisy chained  
90° tilting, 360° rotation  
Adjustable beam angle from 30° to 60°  
5-year warranty

### Finish

- **BK** Black
- **WH** White

### Accessories

- RFP-23I**  
Rough-in plate
- RFP-UNI**  
Universal rough-in plate
- REC-CC-EXT8FT**  
8-foot extension cable
- REC-CC-EXT20FT**  
20-foot extension cable

### Multi-voltage (V) ⚡

This product family offers multi-voltage drivers (120/277/347) that are dimmable using 0-10V dimming systems. Please note that longer lead times may apply for this option. Kindly reach out to your DALI representative for additional information and to confirm availability.

### Note

Other color temperatures, finishes, and voltage options are available but may require minimum order quantities (MOQs) and longer lead times. Please contact your DALI representative for more information.

UPGRADE

# HORUS

A versatile lighting solution with a flexible design for precise illumination, its gimbal mechanism allows users to easily adjust the light angle, making it ideal for residential or commercial settings. The compact 3-inch size is suitable for tight spaces, and the spotlight's focused beam makes it perfect for accent lighting or task-oriented applications.



COLOR TEMPERATURE



DAMP



360°  
SWIVEL/DIRECTIONAL



AIR TIGHT

IC

RATED



Model	Size	Watts	Delivered lumens	CRI	Color °T	Voltage options ⚡
GSP3-CC	3"	12 W	950 lm	90	2700, 3000, 3500, 4000, 5000 K	<b>120V TRIAC dimming</b>

or

**V: 120 / 277 / 347V**  
**0-10V dimming**  
(Check for availability)



**GSP3-CC**

Ø2-3/4"

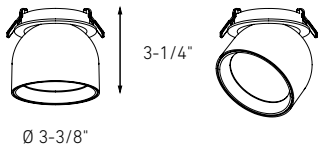

### Specifications

Every fixture includes a junction box with an integrated driver  
 Switch-selectable CCT  
 60° beam angle  
 30° tilting, 360° rotation  
 Cast aluminum construction  
 5-year warranty

### Finish

- **BK** Black
- **GD** Gold
- **WH** White

### Accessories

- RFP-23**  
Rough-in plate
- RFP-UNI**  
Universal rough-in plate
- GSP-CC-EXT8FT**  
8-foot extension cable
- GSP-CC-EXT20FT**  
20-foot extension cable

### Multi-voltage (V) ⚡

This product family offers multi-voltage drivers (120/277/347) that are dimmable using 0-10V dimming systems. Please note that longer lead times may apply for this option. Kindly reach out to your DALI representative for additional information and to confirm availability.

### Note

Other color temperatures, finishes, and voltage options are available but may require minimum order quantities (MOQs) and longer lead times. Please contact your DALI representative for more information.

# REVOLVE

Our Recessed family has grown with a new range of adjustable downlights. The effortless design and high functionality of these fixtures are sure to make a welcome addition in any room.

**GBR35-CC, GBR35-DW**



**GBR04-CC, GBR04-DW**



**GBR06-CC, GBR06-DW**



**GBR35SQ-CC**



NEW



COLOR TEMPERATURE



IC  
RATED

T24  
JA8  
CERTIFIED

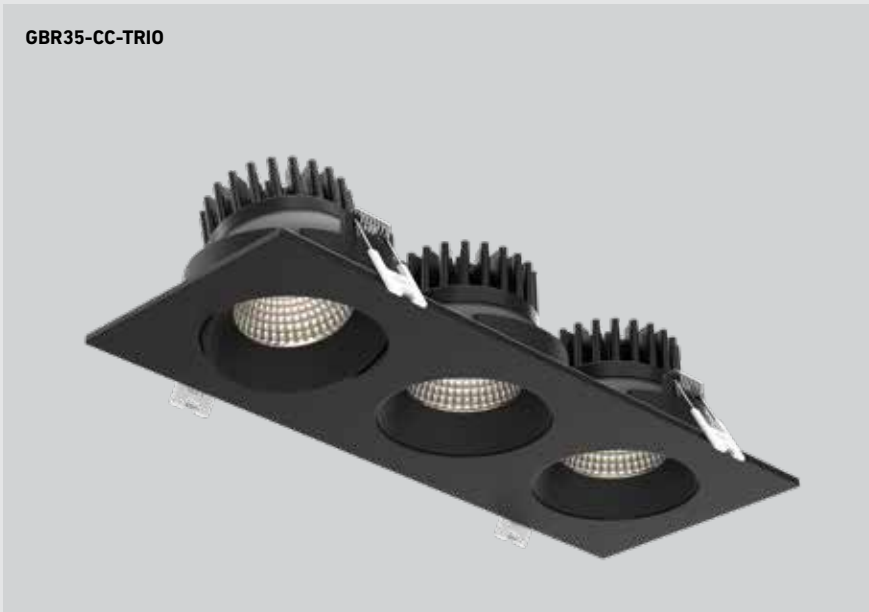
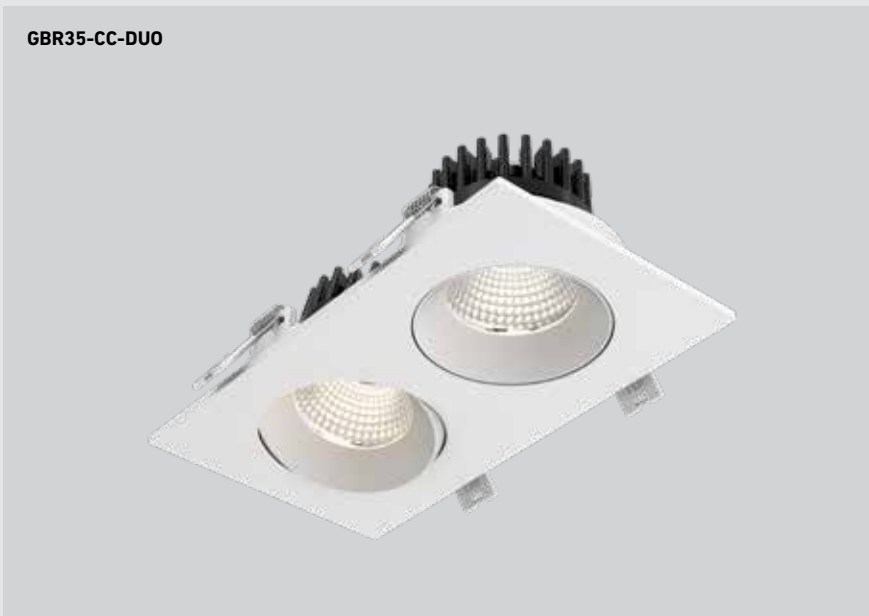

\*Models GBR35-DW , GBR04-DW, GBR06-DW only

\*\*Model GBR04-CC only

NEW

# REVOLVE

Our Recessed family has grown with a new range of adjustable downlights. The effortless design and high functionality of these fixtures are sure to make a welcome addition in any room.

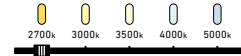

COLOR TEMPERATURE



WET



WARM DIMMING\*



LOW-GLARE



30°  
SWIVEL/DIRECTIONAL



AIR TIGHT

IC  
RATED

T24  
JA8  
CERTIFIED



Model	Size	Watts	Delivered lumens	CRI	Color °T	Voltage options ⚡
GBR35-CC	3.5"	12 W	860 lm	90	2700, 3000, 3500, 4000, 5000 K	<b>120V TRIAC dimming</b>
GBR04-CC	4"	15 W	1240 lm			or
GBR06-CC	6"	20 W	1500 lm			
GBR35-DW†	3.5"	12 W	825 lm		3000 K - 2200 K	<b>V: 120 / 277 / 347V 0-10V dimming</b> (Check for availability)
GBR04-DW†	4"	15 W	1210 lm			
GBR06-DW†	6"	20 W	1540 lm			
GBR35SQ-CC	3.5"	12 W	860 lm		2700, 3000, 3500, 4000, 5000 K	
GBR35-CC-DUO	2x 3.5"	24 W	1740 lm			
GBR35-CC-TRIO	3x 3.5"	36 W	3010 lm			

\*Models GBR35-DW , GBR04-DW, GBR06-DW only

\*\*Model GBR04-CC only

†Not available in multi-voltage



**GBR35-CC, GBR35-DW** Ø3-1/2" 

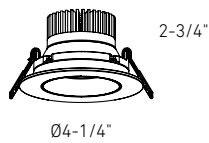

**GBR04-CC, GBR04-DW** Ø4-1/4" 

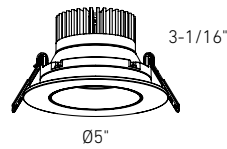

**GBR06-CC, GBR06-DW** Ø6-1/2" 

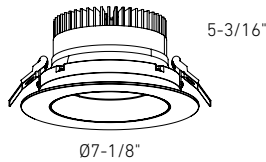

**GBR35SQ-CC** Ø3-1/2" 

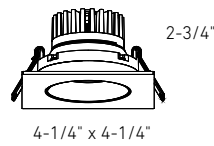

**GBR35-CC-DUO** 7-1/8" x 3-1/2" 

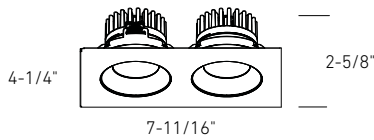

**GBR35-CC-TRIO** 10-1/2" x 3-1/2" 

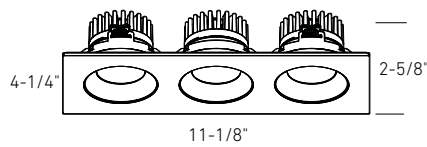

## Specifications

- Every fixture includes a junction box with an integrated driver
- Can be daisy chained
- 30° tilting, 360° rotation
- Switch-selectable CCT (CC models only)
- Dim-to-warm technology, dims from 3000 K to 2200 K to mimic incandescent light (GBRXX-DW models only)
- 40° beam angle
- 30° tilting, 360° rotation
- 5-year warranty

## Finish

- **BK** Black
- **WH** White

## Accessories

- RFP-35**  
Rough-in plate for GBR35, GBR35SQ
- RFP-UNI**  
Universal rough-in plate for GBR04, GBR06
- RFP-46**  
Rough-in plate for GBR04, GBR06
- RFP-DUO**  
Rough-in plate for GBR35-DUO
- RFP-TRIO**  
Rough-in plate for GBR35-TRIO
- REC-CC-EXT8FT**  
8-foot extension cable for GBRXX-CC models
- REC-CC-EXT20FT**  
20-foot extension cable for GBRXX-CC models
- REC-3K-EXT8FT**  
8-foot extension cable for GBRXX-DW models
- REC-3K-EXT20FT**  
20-foot extension cable for GBRXX-DW models

## Multi-voltage (V) ⚡

This product family offers multi-voltage drivers (120/277/347) that are dimmable using 0-10V dimming systems. Please note that longer lead times may apply for this option. Kindly reach out to your DALI representative for additional information and to confirm availability.

## Note

Other color temperatures, finishes, and voltage options are available but may require minimum order quantities (MOQs) and longer lead times. Please contact your DALI representative for more information.

# PIVOT

When searching for lighting flexibility, look no further than our 3", 4" & 6" flat gimbal LED downlights. With powerful lumen output and the ability to direct light with a 360° rotation and a 90° tilt angle, this product will meet your every need.

**FGM4-3K, FGM4-CC**



**FGM2-CC**



**FGM3-CC**



**FGM6-CC**



**FGM4SQ-CC**

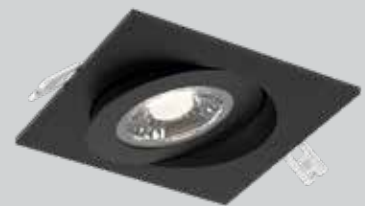

NEW



COLOR TEMPERATURE\*



WET

90°

SWIVEL/DIRECTIONAL



AIR TIGHT

IC

RATED

T24  
JA8

CERTIFIED



Intertek

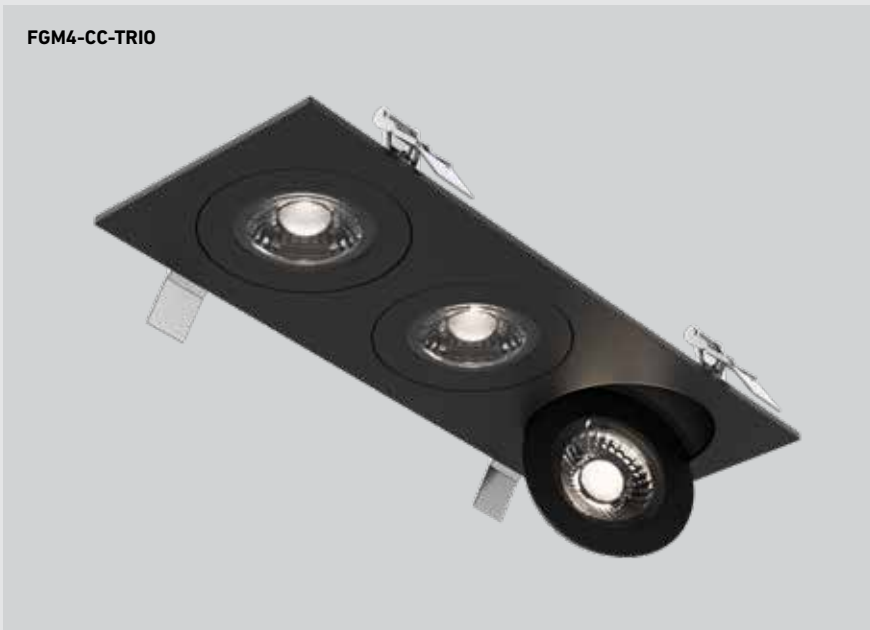

\*Not available for model FGM4-3K

\*\*Models FGM3-3k, FGM3-CC, FGM4-CC, and FGM4SQ-CC only

NEW

# PIVOT

When searching for lighting flexibility, look no further than our 4-inch square flat gimbal LED downlight. With a powerful lumen output and the ability to direct light through a 360° rotation and a 90° tilt angle, this product will meet all your lighting needs.



COLOR TEMPERATURE\*



WET

90°

SWIVEL/DIRECTIONAL



AIR TIGHT

IC

RATED

T24  
JA8

CERTIFIED



Intertek



Model	Size	Watts	Delivered lumens	CRI	Color °T	Voltage options ⚡
FGM4-3K	4"	9 W	700 lm	90	3000 K	120V TRIAC dimming
FGM2-CC	2"	6 W	500 lm		2700, 3000, 3500, 4000, 5000 K	
FGM3-CC	3"	6 W	570 lm			or
FGM4-CC	4"	9 W	800 lm			V: 120 / 277 / 347V 0-10V dimming (Check for availability)
FGM6-CC	6"	14 W	1050 lm			
FGM4SQ-CC	4"	9 W	800 lm			
FGM4-CC-DUO	2x 4"	18 W	1475 lm			
FGM4-CC-TRIO	3x 4"	27 W	2300 lm			

\*Not available for model FGM4-3K

\*\*Models FGM3-3k, FGM3-CC, FGM4-CC, and FGM4SQ-CC only

**FGM2-CC**

Ø2-3/4"

**FGM3-CC**

Ø3-3/8"

**FGM4-CC**

Ø4-1/4"

**FGM6-CC**

Ø6-1/4"

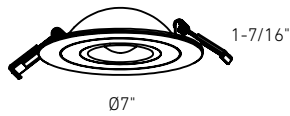
**FGM4SQ**

Ø4-1/4"

**FGM4-CC-DUO**

8-5/8" X 4-3/4"

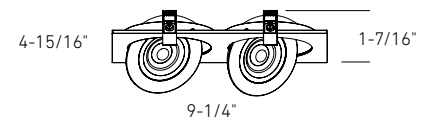
**FGM4-CC-TRIO**

13" X 4-5/8"

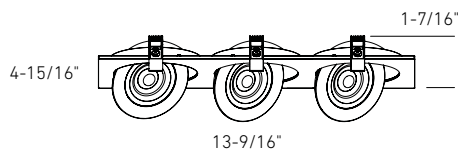
**Specifications**

Every fixture includes a junction box with integrated dimmable driver  
 Can be daisy chained  
 90° tilting, 360° rotation  
 Aluminum construction  
 Switch-selectable CCT  
 Low profile  
 40° beam spread  
 5-year warranty

**Finish**

- **BK** Black
- **SN** Satin Nickel (FGM4, FGM6 only)
- **WH** White

**Accessories**

- RFP-UNI**  
Universal rough-in plate
- RFP-23**  
Rough-in plate for 3" model
- RFP-46**  
Rough-in plate for 4" and 6" models
- RFP-DUO**  
Rough-in plate for FGM4-CC-DUO
- RFP-TRIO**  
Rough-in plate for FGM4-CC-TRIO
- REC-3K-EXT8FT**  
8-foot extension cable for FGM4-3K
- REC-3K-EXT20FT**  
20-foot extension cable for FGM4-3K
- REC-CC-EXT8FT**  
8-foot extension cable for FGMX-CC models
- REC-CC-EXT20FT**  
20-foot extension cable for FGMX-CC models

**Multi-voltage (V)**

This product family offers multi-voltage drivers (120/277/347) that are dimmable using 0-10V dimming systems. Please note that longer lead times may apply for this option. Kindly reach out to your DALI representative for additional information and to confirm availability.

**Note**

Other color temperatures, finishes, and voltage options are available but may require minimum order quantities (MOQs) and longer lead times. Please contact your DALI representative for more information.

# SCOPE

There are moments when you want the ability to direct light as you please. With our LED Gimbal recessed fixture, this has now become a reality with the easiest of installations.

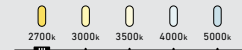

COLOR TEMPERATURE



WET



SWIVEL/DIRECTIONAL



AIR TIGHT

**IC**  
RATED

**T24**  
**JA8**  
CERTIFIED



Model	Size	Watts	Delivered lumens	CRI	Color °T	Voltage options ⚡
GMB2-CC	2"	8 W	725 lm	90	2700, 3000, 3500, 4000, 5000 K	<b>120V TRIAC dimming</b>
LEDDOWNG3-CC	3"	8 W	680 lm			or
GMB4-CC	4"	11 W	810 lm			<b>V: 120 / 277 / 347V 0-10V dimming</b> (Check for availability)

**GMB2-CC**

Ø2-1/4"



1-5/8"

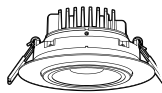

Ø2-1/2"

**GMB4-CC**

Ø4-1/4"



1-5/8"

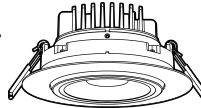

Ø4-7/8"

**LEDDOWNG3-CC**

Ø2-3/4"



2"

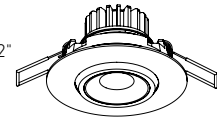

Ø3-1/4"



### Specifications

Every fixture includes a junction box with integrated dimmable driver

Can be daisy chained (3" and 4" models only)

30° tilting, 360° rotation

Aluminum construction

Switch-selectable CCT

Low profile

40° beam spread

5-year warranty

### Finish

- **BK** Black
- **SN** Satin Nickel (3" and 4" models only)
- **WH** White

### Accessories

#### **RFP-UNI**

Universal rough-in plate for 3" and 4" models

#### **RFP-GMB2**

Rough-in plate for GMB2-CC

#### **RFP-23**

Rough-in plate for LEDDOWNG3-CC

#### **RFP-46**

Rough-in plate for GMB4-CC

#### **REC-CC-EXT8FT**

8-foot extension cable

#### **REC-CC-EXT20FT**

20-foot extension cable

### Multi-voltage (V) ⚡

This product family offers multi-voltage drivers (120/277/347) that are dimmable using 0-10V dimming systems. Please note that longer lead times may apply for this option. Kindly reach out to your DALI representative for additional information and to confirm availability.

### Note

Other color temperatures, finishes, and voltage options are available but may require minimum order quantities (MOQs) and longer lead times. Please contact your DALI representative for more information.

# FUSION

The Fusion is a slim gimbal recessed panel with 5CCT, offering advanced lighting flexibility for precise illumination. Its gimbal design allows users to direct light as needed, and the 5CCT feature provides color temperature versatility, making the Fusion an ideal choice for both residential and commercial applications.



COLOR TEMPERATURE



WET



SWIVEL/DIRECTIONAL



AIR TIGHT

**IC**  
RATED

**T24**  
**JA8**  
CERTIFIED



Model	Size	Watts	Delivered lumens	CRI	Color °T	Voltage options ⚡
GPN4-CC	4"	10 W	850 lm	90	2700, 3000, 3500, 4000, 5000 K	<b>120V</b> <b>TRIAC dimming</b>
GPN6-CC	6"	13 W	1050 lm			

or

**V: 120 / 277 / 347V**  
**0-10V dimming**  
(Check for availability)



**GPN4-CC**

Ø4-1/4"

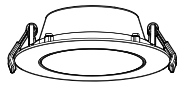

1-1/2"

Ø4-15/16"

**GPN6-CC**

Ø6-1/4"

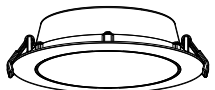

1-3/4"

Ø7"

**Specifications**

Every fixture includes a junction box with an integrated driver

Switch-selectable CCT

110° beam angle

25° tilting, 360° rotation

Cast aluminum construction

5-year warranty

**Finish**

● **BK** Black

○ **WH** White

**Accessories****RFP-UNI**

Universal rough-in plate

**RFP-46**

Rough-in plate for 4" and 6" models

**GPN-CC-EXT8FT**

8-foot extension cable

**GPN-CC-EXT20FT**

20-foot extension cable

**Multi-voltage (V) ⚡**

This product family offers multi-voltage drivers (120/277/347) that are dimmable using 0-10V dimming systems. Please note that longer lead times may apply for this option. Kindly reach out to your DALI representative for additional information and to confirm availability.

**Note**

Other color temperatures, finishes, and voltage options are available but may require minimum order quantities (MOQs) and longer lead times. Please contact your DALI representative for more information.

# MYSTIQUE

If you are looking for a sleek, attractive LED option for your ceilings, then our color-changing panel light with interchangeable trims is the perfect choice. With the flick of a switch, you have the ability to select one of five pre-set color temperatures – 2700K, 3000K, 3500K, 4000K, and 5000K – convenience at your fingertips.

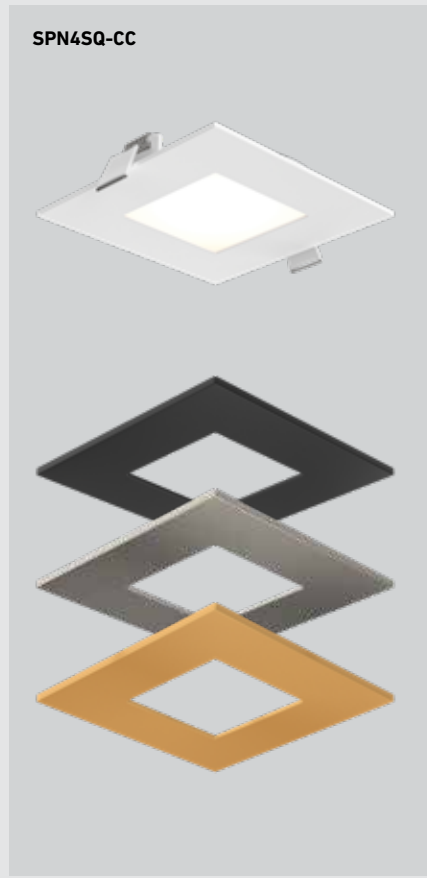
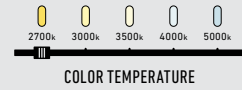

Model	Size	Watts	Delivered lumens	CRI	Color °T	Voltage options ⚡
SPN4-CC	4"	11 W	800 lm	90	2700, 3000, 3500, 4000, 5000 K	<b>120V TRIAC dimming</b>
SPN4SQ-CC	4"	11 W	800 lm			or
SPN6-CC	6"	14 W	1100 lm			<b>V: 120 / 277 / 347V</b>
SPN6SQ-CC	6"	14 W	1100 lm			<b>0-10V dimming</b> (Check for availability)

**SPN4-CC**

Ø4-1/4"



**SPN6-CC**

Ø6-1/2"

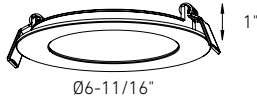

**SPN4SQ-CC**

Ø4-1/4"

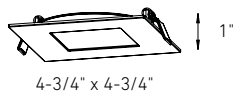

**SPN6SQ-CC**

Ø6-1/2"

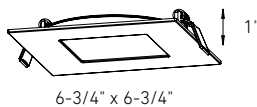

### Specifications

Every fixture includes a junction box with integrated dimmable driver  
Can be daisy chained  
Switch-selectable CCT  
3 interchangeable trim colors included  
110° beam angle  
Aluminum construction  
5-year warranty

### Finish

- **BK** Black
- **GD** Gold
- **SN** Satin Nickel
- **WH** White

### Accessories

- RFP-UNI**  
Universal rough-in plate
- RFP-46**  
Rough-in plate for 4" and 6" models
- 5000-EXT8FT**  
8-foot extension cable
- 5000-EXT20FT**  
20-foot extension cable

### Multi-voltage (V) ⚡

This product family offers multi-voltage drivers (120/277/347) that are dimmable using 0-10V dimming systems. Please note that longer lead times may apply for this option. Kindly reach out to your DALI representative for additional information and to confirm availability.

### Note

Other color temperatures, finishes, and voltage options are available but may require minimum order quantities (MOQs) and longer lead times. Please contact your DALI representative for more information.

# EXCEL

LED panel lights are more accessible than ever before. The sleek and minimal construction allows for the easiest of installations.

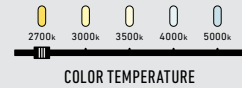

Model	Size	Watts	Delivered lumens	CRI	Color °T	Voltage options ⚡
5003-CC	3"	8 W	600 lm	90	2700, 3000, 3500, 4000, 5000 K	120V TRIAC dimming
5004-CC	4"	11 W	800 lm			or
5005-CC	5"	12 W	900 lm			V: 120 / 277 / 347V 0-10V dimming (Check for availability)
5006-CC	6"	14 W	1100 lm			
5004SQ-CC	4"	11 W	800 lm			
5004-FR-CC*	4"	11 W	825 lm	80		
5006-FR-CC*	6"	14 W	1230 lm	80		
5004-DW**	4"	11 W	850 lm	80	3000 K - 2200 K	120V

<sup>1</sup>Model 5004-DW only

<sup>2</sup>Models 5004-FR-CC, 5006-FR-CC only

\*2-hour fire-rated without additional housing or hardware, in accordance with UL 263, ASTM E119, and CAN ULC S101

\*\*Dim-to-warm technology dims from 3000 K to 2200 K, Not available in multi-voltage

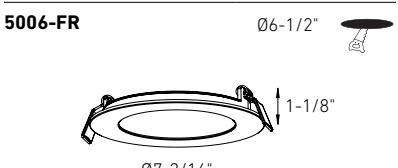
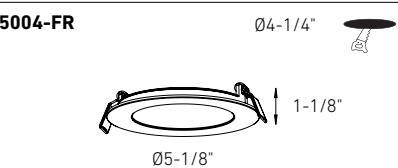
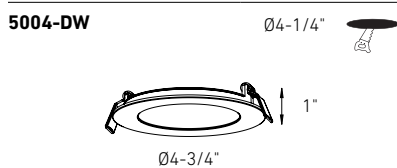
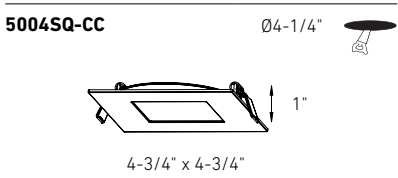
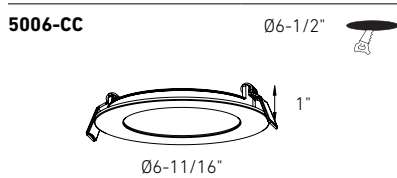
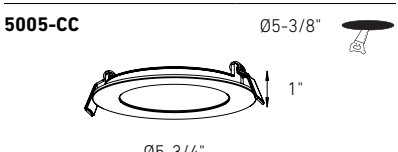
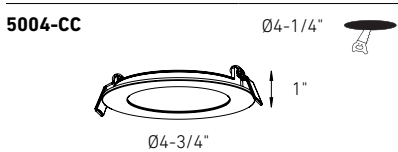
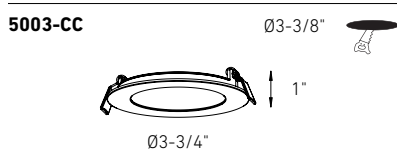

**Specifications**

- Every fixture includes a junction box with an integrated driver
- Can be daisy chained
- Smooth 360° wide spread
- Frosted lens
- Edge lit technology
- Aluminum construction
- Switch-selectable CCT
- Very low profile
- 5-year warranty

**Finish**

- **BK** Black (3", 4", and 6" models only)
- **SN** Satin Nickel (5004, 5004-DW only)
- **WH** White

**Multi-voltage (V) ⚡**

This product family offers multi-voltage drivers (120/277/347) that are dimmable using 0-10V dimming systems. Please note that longer lead times may apply for this option. Kindly reach out to your DALI representative for additional information and to confirm availability.

**Note**

Other color temperatures, finishes, and voltage options are available but may require minimum order quantities (MOQs) and longer lead times. Please contact your DALI representative for more information.

**Accessories**

- REC-TRIM4-BK/GD/SN** (5004)  
4" recessed panel trim in black, gold, or satin nickel
- REC-PT4-GD** (5004-DW)  
4" recessed panel trim in gold or satin nickel
- REC-TRIM6-BK/GD/SN** (5006)  
6" recessed panel trim in black, gold, or satin nickel
- 5000-EXT8FT**  
8-foot extension cable
- 5000-EXT20FT**  
20-foot extension cable
- RFP-23** (5003)  
Rough-in plate
- RFP-46** (5004, 5006)  
Rough-in plate
- RFP-58** (5005)  
Rough-in plate
- RFP-UNI** (5003, 5004, 5006)  
Universal rough-in plate

# ACCESS

LED panel lights are more accessible than ever before. The sleek and minimal construction allows for the easiest of installations.



**IC**  
RATED



Model	Size	Watts	Delivered lumens	CRI	Color °T	Voltage
2003	3"	6 W	400 lm	80	3000 K	120 V
2004	4"	9 W	600 lm			
2006	6"	11 W	800 lm			

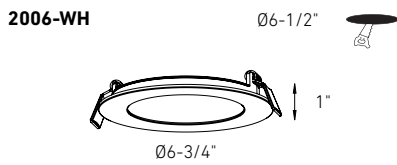
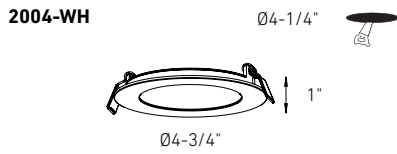

### Specifications

- Every fixture includes a junction box with an integrated driver
- Can be daisy chained
- Superior LED performance and lifespan
- Frosted lens
- Edge lit technology
- Aluminum construction
- Very low profile
- 5-year warranty

### Finish

- WH** White

### Note

Other color temperatures, finishes, and voltage options are available but may require minimum order quantities (MOQs) and longer lead times. Please contact your DALI representative for more information.

### Accessories

**REC-TRIM4-BK/GD/SN** (2004)  
4" recessed panel trim in black, gold, or satin nickel

**REC-TRIM6-BK/GD/SN** (2006)  
6" recessed panel trim in black, gold, or satin nickel

**2000-EXT8FT**  
8-foot extension cable

**2000-EXT20FT**  
20-foot extension cable

**RFP-23**  
Rough-in plate for 2003

**RFP-46**  
Rough-in plate for 2004, 2006

**RFP-UNI**  
Universal rough-in plate for 2004, 2006

NEW

# ALTER SERIES

This aluminum retrofit LED panel offers the easiest and most practical solution for upgrading your outdated recessed lighting. For style and convenience, the removable outer trim attaches with magnetic fasteners, creating a seamless look. It can be easily retrofitted into existing 4" canisters or standard octagonal junction boxes.

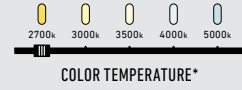

**T24  
JA8**  
CERTIFIED



Model	Size	Watts	Delivered lumens	CRI	Color °T	Voltage
RTJB4-3K	4"	9 W	550 lm	90	3000 K	120 V
RTJB3-CC	3"	8 W	620 lm		2700, 3000, 3500, 4000, 5000 K	
RTJB4-CC	4"	9 W	565 lm			

\*Not available for model RTJB4-3K



### RTJB3-CC

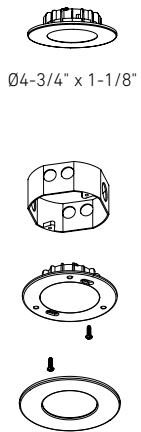

### RTJB4-XX + RTJB4-ACC

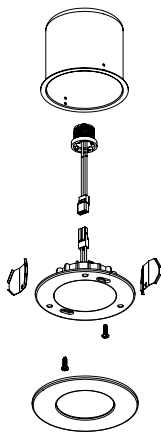

### RTJB4-XX

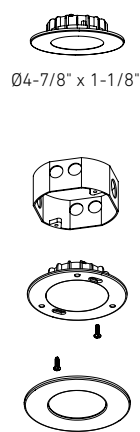

### Specifications

- Fits on U.S. and Canadian octagonal junction boxes (RTJB3 only)
- Integrated dimmable driver
- Fire rated alternative when mounted onto a fire rated junction box
- Minimal heat emission
- Aluminum construction
- Switch-selectable CCT (models RTJB3-CC, RTJB4-CC only)
- Magnetic trim finish
- 5-year warranty

### Finish

- WH** White

### Accessories

- RTJB4-ACC**  
4" recessed can mounting kit for RTJB4-XX - clips and E26 socket
- RTJB4-TRIM-BK**  
4" recessed panel trim in black

### Note

Other color temperatures, finishes, and voltage options are available but may require minimum order quantities (MOQs) and longer lead times. Please contact your DALI representative for more information.

# ALTER SERIES

Our LED retrofit panels provide the perfect solution for your renovations. There's no need to completely change your current lighting, simply use these innovative products and retrofit your existing installation. The change will be illuminating.

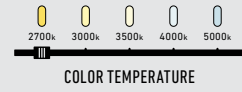

**T24  
JA8**  
CERTIFIED



Model	Size	Watts	Delivered lumens	CRI	Color °T	Voltage
LEDPNLRTF56-CC	6"	10 W	720 lm	90	2700, 3000, 3500, 4000, 5000 K	120 V

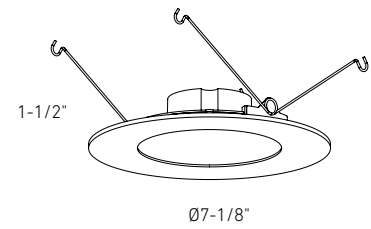

---

**LEDPNLRTF56-CC**

---

**Specifications**

120V AC, A19 bulb replacement  
Fits into 5-1/2" to 6" recessed housings  
Integrated dimmable driver  
Switch-selectable CCT  
Aluminum trim and housing  
Frosted lens  
Edge-lit technology  
Very low profile  
5-year warranty

---

**Finish**

○ **WH** White

---

**Note**

Other color temperatures, finishes, and voltage options are available but may require minimum order quantities (MOQs) and longer lead times. Please contact your DALI representative for more information.

# ACCESSORIES

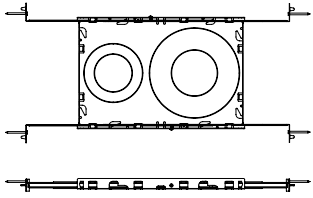
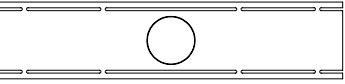
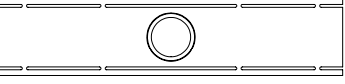
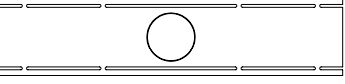
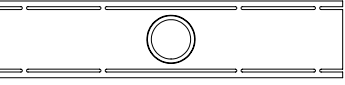
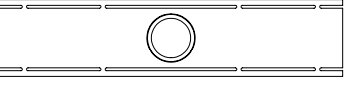
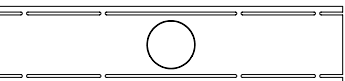
Model	Description		Specifications
<b>RFP-UNI</b>	Universal drilling plate	 <p> <math>\varnothing 2 \frac{3}{4}</math>"  <math>\varnothing 3 \frac{3}{8}</math>"  <math>\varnothing 4 \frac{1}{4}</math>"  <math>\varnothing 6 \frac{1}{2}</math>" </p>	<p>Expandable with on-center spacing up to 24"</p> <p>Plates serve as template for cutting precise product openings (Please refer to product cut size)</p> <p>Adds extra support and allows for easy and quick installation</p> <p>Galvanized steel finish</p>
<b>RFP-GMB2</b>	Drilling plate for GMB2-CC recessed fixture	 <p><math>\varnothing 2\text{-}1\frac{1}{4}</math>"</p>	<p>Plates serve as template for cutting precise product openings (Please refer to product cut size)</p> <p>Adds extra support and allows for easy and quick installation</p> <p>Galvanized steel finish</p>
<b>RFP-23</b>	Drilling plate for 2 and 3" fixtures	 <p> <math>\varnothing 2\text{-}3\frac{1}{4}</math>"  <math>\varnothing 3\text{-}3\frac{1}{8}</math>" </p>	<p>Plates serve as template for cutting precise product openings (Please refer to product cut size)</p> <p>Adds extra support and allows for easy and quick installation</p> <p>Galvanized steel finish</p>
<b>RFP-35</b>	Drilling plate for 3.5" fixtures	 <p><math>\varnothing 3\text{-}1\frac{1}{2}</math>"</p>	<p>Plates serve as template for cutting precise product openings (Please refer to product cut size)</p> <p>Adds extra support and allows for easy and quick installation</p> <p>Galvanized steel finish</p>
<b>RFP-46</b>	Drilling plate for 4 and 6" fixtures	 <p> <math>\varnothing 4\text{-}1\frac{1}{4}</math>"  <math>\varnothing 6\text{-}1\frac{1}{2}</math>" </p>	<p>Plates serve as template for cutting precise product openings (Please refer to product cut size)</p> <p>Adds extra support and allows for easy and quick installation</p> <p>Galvanized steel finish</p>
<b>RFP-58</b>	Drilling plate for 5 and 8" fixtures	 <p> <math>\varnothing 5\text{-}3\frac{1}{8}</math>"  <math>\varnothing 7\text{-}1\frac{1}{2}</math>" </p>	<p>Plates serve as template for cutting precise product openings (Please refer to product cut size)</p> <p>Adds extra support and allows for easy and quick installation</p> <p>Galvanized steel finish</p>
<b>RFP-RC06</b>	Drilling plate for 6" customizable recessed fixture	 <p><math>\varnothing 6</math>"</p>	<p>Plates serve as template for cutting precise product openings (Please refer to product cut size)</p> <p>Adds extra support and allows for easy and quick installation</p> <p>Galvanized steel finish</p>



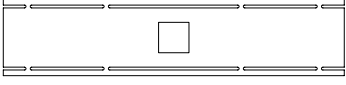
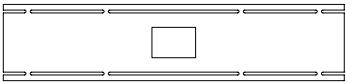
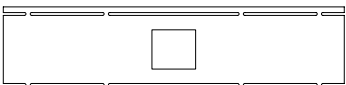
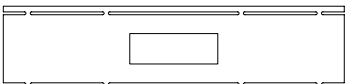
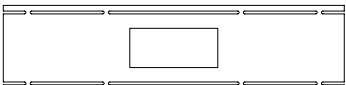
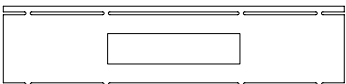
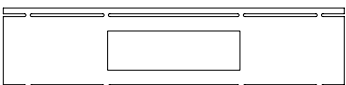



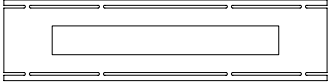
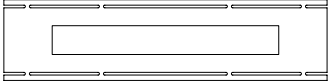
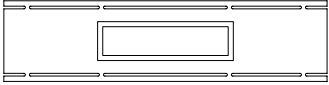
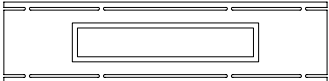

Model	Description		Specifications
<b>RFP-MSL1</b>	Drilling plate for MSL1 recessed fixture 	1-9/16" X 1-9/16"	Plates serve as template for cutting precise product openings (Please refer to product cut size) Adds extra support and allows for easy and quick installation Galvanized steel finish
<b>RFP-MSL2</b>	Drilling plate for MSL2 recessed fixture 	1-9/16" X 2-5/8"	Plates serve as template for cutting precise product openings (Please refer to product cut size) Adds extra support and allows for easy and quick installation Galvanized steel finish
<b>RFP-MSL4</b>	Drilling plate for MSL4 recessed fixture 	2-3/4" X 2-3/4"	Plates serve as template for cutting precise product openings (Please refer to product cut size) Adds extra support and allows for easy and quick installation Galvanized steel finish
<b>RFP-MSL5</b>	Drilling plate for MSL5 recessed fixture 	5-1/2" X 1-5/8"	Plates serve as template for cutting precise product openings (Please refer to product cut size) Adds extra support and allows for easy and quick installation Galvanized steel finish
<b>RFP-MSL5G</b>	Drilling plate for MSL5G recessed fixture 	6-3/8" X 2-3/4"	Plates serve as template for cutting precise product openings (Please refer to product cut size) Adds extra support and allows for easy and quick installation Galvanized steel finish
<b>RFP-MSL10</b>	Drilling plate for MSL10 recessed fixture 	10-3/4" X 1-5/8"	Plates serve as template for cutting precise product openings (Please refer to product cut size) Adds extra support and allows for easy and quick installation Galvanized steel finish
<b>RFP-MSL10G</b>	Drilling plate for MSL10G recessed fixture 	11-1/2" X 2-3/4"	Plates serve as template for cutting precise product openings (Please refer to product cut size) Adds extra support and allows for easy and quick installation Galvanized steel finish

# ACCESSORIES

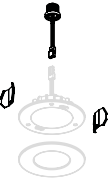
Model	Description		Specifications
<b>RFP-LNR24</b>	Drilling plate for LNR24-CC, LNR24-CC-V, DCP-LNR24	2-1/8" X 23-3/8"	Plates serve as template for cutting precise product openings (Please refer to product cut size)  Adds extra support and allows for easy and quick installation Galvanized steel finish
			
<b>RFP-LNR48</b>	Drilling plate for LNR48-CC, LNR48-CC-V, DCP-LNR48	2-1/8" X 47-3/8"	Plates serve as template for cutting precise product openings (Please refer to product cut size)  Adds extra support and allows for easy and quick installation Galvanized steel finish
			
<b>RFP-DUO</b>	Drilling plate for FGM4-CC-DUO and GBR35-CC-DUO recessed fixtures	7-1/8" X 3-1/2"  8-5/8" X 4-3/4"	Plates serve as template for cutting precise product openings (Please refer to product cut size)  Adds extra support and allows for easy and quick installation Galvanized steel finish
			
<b>RFP-TRIO</b>	Drilling plate for FGM4-CC-TRIO and GBR35-CC-TRIO recessed fixtures	10-3/8" X 3-5/8"  13" X 4-5/8"	Plates serve as template for cutting precise product openings (Please refer to product cut size)  Adds extra support and allows for easy and quick installation Galvanized steel finish
			

Model		Finish	Specification
<b>GMB2-GOOF</b>	 02-1/4" 03-7/8"	White	Goof ring for GMB2 recessed lights Allows 2" fixtures to fit in a hole with a maximum diameter of 3-3/4"
<b>REC-GOOF2</b>	 02-3/4" 03-7/8"	White	Goof ring for 2" recessed lights (not compatible with RGM2) Allows 2" fixtures to fit in a hole with a maximum diameter of 3-3/4"
<b>LEDDOWNACC-GOOF3</b>	 03-3/8" 05-1/4"	White	Goof ring for 3" recessed lights Allows 3" fixtures to fit in a hole with a maximum diameter of 4-3/4"
<b>LEDDOWNACC-GOOF4</b>	 04-3/8" 06-1/2"	White Black	Goof ring for 4" recessed lights Allows 4" fixtures to fit in a hole with a maximum diameter of 6"
<b>LEDDOWNACC-GOOF6</b>	 06-1/2" 08-1/2"	White	Goof ring for 6" recessed lights Allows 6" fixtures to fit in a hole with a maximum diameter of 8"

Model		Finish	Specification
REC-PT4-GD		Gold	4" recessed panel trim Compatible products: 5004-DW
REC-TRIM4-BK REC-TRIM4-GD REC-TRIM4-SN REC-TRIM6-BK REC-TRIM6-GD REC-TRIM6-SN		Black Gold Satin Nickel	4" and 6" panel trims Compatible products: 2004, 2006 5004-CC, 5006-CC
RTJB4-TRIM-BK		Black	4" recessed panel trim Compatible products: RTJB4-3K, RTJB4-CC
RTJB4-ACC		-	4" recessed can mounting kit for RTJB4-XX - clips and E26 socket
DDP4-TRIM-BK DDP6-TRIM-BK		Black	4" and 6" recessed panel trims Compatible products: DDP4-CC, DCP-DDP4, DDP6-CC, DCP-DDP6
DRR4-TRIM-BK DRR4-TRIM-SBA DRR6-TRIM-BK DRR6-TRIM-SBA		Black Sandblasted aluminum	4" and 6" recessed panel trims Compatible products: DRR4-CC, DRR6-CC
2000-EXT8FT 2000-EXT20FT REC-3K-EXT8FT REC-3K-EXT20FT		White	8-foot extension cord for 2-pin recessed fixtures 20-foot extension cord for 2-pin recessed fixtures  Male/female connector for quick-connect installation. Connect together for a total length of up to 40 feet
5000-EXT8FT 5000-EXT20FT GPN-CC-EXT8FT GPN-CC-EXT20FT GSP-CC-EXT8FT GSP-CC-EXT20FT REC-CC-EXT8FT REC-CC-EXT20FT		White	8-foot extension cord for 3-pin recessed fixtures 20-foot extension cord for 3-pin recessed fixtures  Male/female connector for quick-connect installation. Connect together for a total length of up to 40 feet





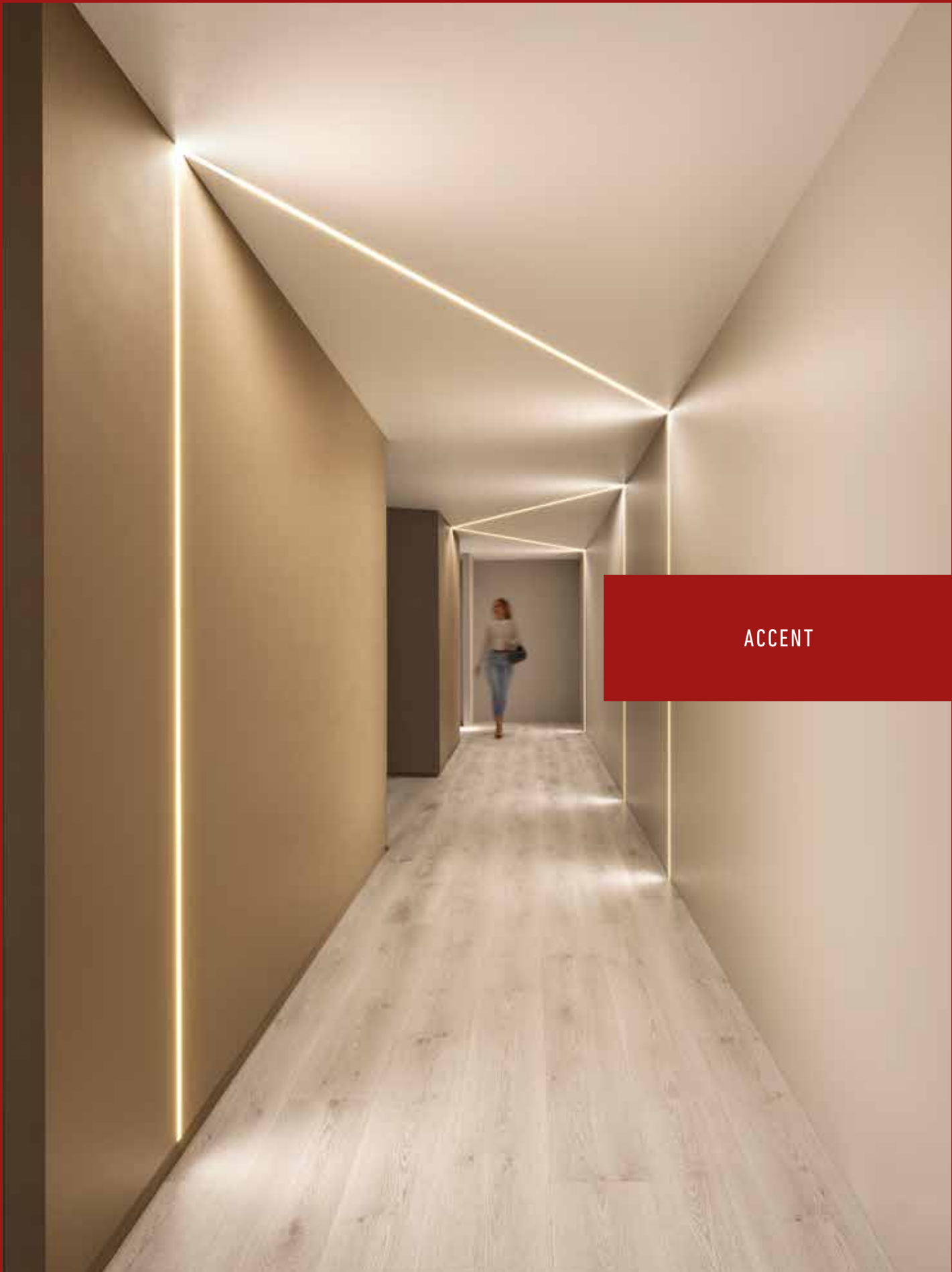

ACCENT

12 V

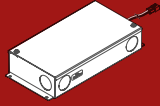

86  
**INSTALLATION  
GUIDE**

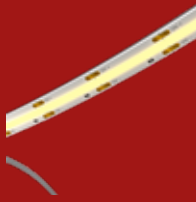

88  
**COB-TAPE**  
COBTP1M/ COBTP5M/  
COBTP-REEL



90  
**SWIVLED12-CC**



91  
**SUPER-PUCK  
RECESSED**  
4001-CC



92  
**DUO-PUCK**  
4005-CC  
K4005-CC



93  
**MINI-PUCK**  
LEDRDM1



94  
**ECO-PUCK**  
LEDRDP18



95  
**SLIDE**  
DD1260

24 V



96  
**COB-TAPE**  
COBTP24V-K10FT-CC  
COBTP24V-K20FT-CC  
COBTP24V-R50FT-CC  
COBTP24V-R100FT-CC

120 V



98  
**POWERLED PUCK**  
6001-CC



99  
**POWERLED LINEAR**  
6009CC/ 6012CC/  
6024CC/ 6036CC/  
6048CC100



100  
**PROLED LINEAR**  
HLF09/ HLF12/ HLF18/  
HLF24/ HLF30



102  
**COUNTERLED LINEAR**  
9009CC/ 9012CC/  
9018CC /9024CC/  
9030CC

GENERAL



104  
**LED DIMMABLE  
DRIVERS**



106  
**ACCESSORIES**



# Proper Sizing, Spacing and Lighting Techniques

As its name suggests, under cabinet lighting refers to lights that are installed under a cabinet, resulting in illumination of the area immediately below a section of cabinets. It is most commonly used in kitchen areas, where additional lighting is useful for food preparation.

## Types of under cabinet lighting



### Puck lights

Pucks are the most versatile products as they can be installed in any application. Most of our pucks can be either surface-mounted or recessed into cabinetry, ensuring a flush surface appearance. Our pucks are designed to provide smooth and uniform light output.

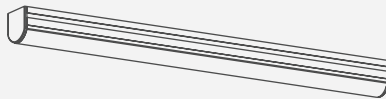

### Linears

Linears are ideal for efficient and uniform solutions. All our linears are designed for surface mounting, and many of them can pivot to focus on features such as the backsplash. Most linears come in various sizes, allowing them to be combined to cover the length of most surfaces.

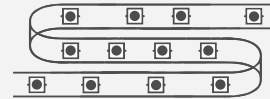

### Tape lights

Tape lights are flexible rolls of LEDs with adhesive backs, suitable for virtually any application, extending beyond under-cabinet lighting. Tape lights have a super low profile and are easy to install.

### How many do I need?

If you are installing pucks, we recommend spacing them approximately 24 inches apart. For linears, you can either seamlessly install them from end to end or leave a gap equivalent to the size of the product.

## Power source

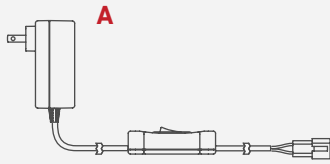

### Low-voltage (12V)

A 12V system includes a driver and fixtures, with one driver powering multiple products. It allows for compact fixture designs and uses thin, flexible wiring for easier installation.

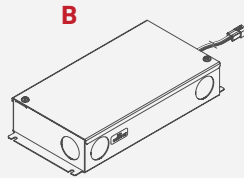

### Low-voltage (24V)

A 24V system also uses a driver and fixtures, supporting longer wiring runs than 12V. It enables sleek designs and employs thin, flexible wiring for streamlined installations.

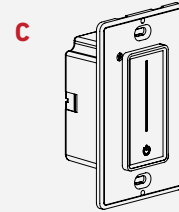

### Direct wire (120V)

120V direct means that no other components are required to power the product. Either the LED's are 120V direct or a driver is integrated in each product. The advantage of a 120V product is the ease of installation.

### Dimmer/driver switch (12V)

Replace your 12V driver with an integrated driver/dimmer to control the brightness of your low-voltage lights. Simply connect this unit to your 120V input current to regulate your low-voltage lighting.

### Choosing the right driver

We offer a wide range of plug-in (A), direct wire (B), and dimmer/driver switches (C). To select the correct driver, simply add up the wattage from all your lights and choose a driver with a higher wattage that suits your specific needs.

## Connections

### Direct wire

Direct wire systems are typically installed by electrical contractors. This means the power feed is connected directly inside the product or driver, without any plugs, and with no exposed wires. Direct wire installations must be enclosed in a connection box with sufficient volume to ensure a safe connection. All our direct wire products feature built-in connection boxes with convenient knockouts to discreetly route the wiring.

### Plug-in

Plug-in options are really easy to install as they plug directly into an electrical outlet.

### Dimmer/driver switch

Dimmer/driver switch systems, two-in-one integrated units often installed by qualified electricians, seamlessly replace your standard wall switch and transformer simultaneously. This involves connecting the power feed directly inside the switch, eliminating the need for plugs and exposed wires.

**GOOD  
TO KNOW!**

For optimal dimming try to use up at least 50% of the driver's capacity. For example, if all products come up to 10 watts, you would be much better off with a 12W driver than a 24W driver.

# COB-TAPE

This tape will not only emit a wonderful warm glow but also provide you with continuous, seamless light. You can cut it every inch and reattach it with the supplied connectors. No more waste.

3000k

COLOR TEMPERATURE



DRY



VOLTAGE



Intertek

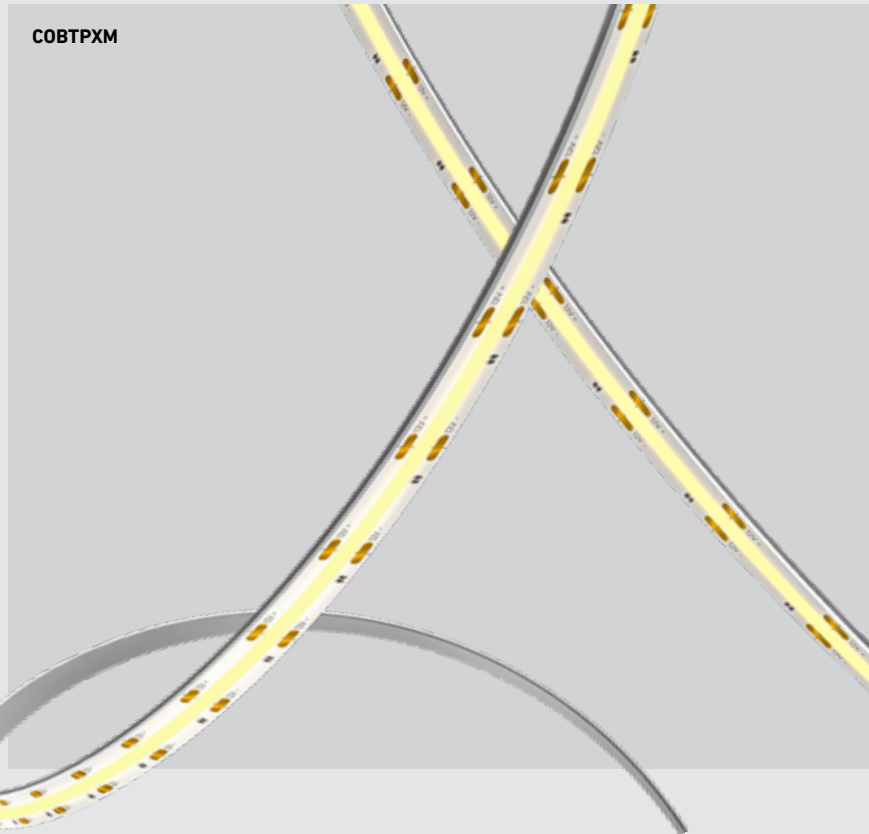

Model	Size	Watts	Delivered lumens	CRI	Color °T	Voltage
<b>COBTP3M</b>	3m (118")	24 W	1500 lm	90	3000 K	12 V
<b>COBTP5M</b>	5m (196")	48 W	2250 lm			
<b>COBTP-REEL*</b>	20m (65')	8 W /meter	500 lm /meter			

\*20m COB reels do not include a 12V driver. Plug-in or hard-wired power supply required for installation. Sold separately.

- COBTP3M**                    1 x 3m
  - COBTP5M**                    1 x 5m
  - COBTP-REEL\***                1 x 20m (65')
- \* Driver not included

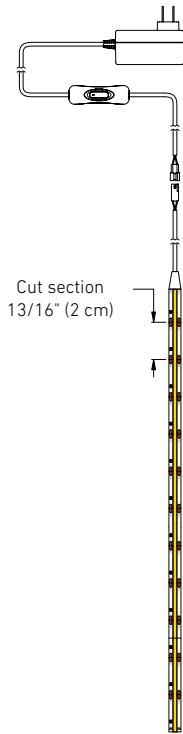

### Specifications

12V DC LED plug-in driver included  
(3m=24w / 5m=48w)

Seamless light emission (360 LEDs/meter)

Can be cut at every cut mark (every 2 cm)

Maximum run length of 5m (196") in a series

Dimmable with DALI dimming power supply and most low-voltage electronic dimmers

5-year warranty

### Power supplies: plug-in

- ETR-LED10WPI**  
12V DC/10W class 2 LED driver
- ETR-LED24WPI**  
12V DC/24W class 2 LED driver

### Power supplies: hard-wired

- DD1260**  
LED driver and dimmer in one unit
- BT06DIM-IC**  
6W dimmable LED hardwire driver
- BT12DIM-IC**  
12W dimmable LED hardwire driver
- BT24DIM-IC**  
24W dimmable LED hardwire driver
- BT36DIM**  
36W dimmable LED hardwire driver
- BT48DIM**  
48W dimmable LED hardwire driver

### Accessories

- COBTP-ALXT-BK**  
1 meter black aluminum extrusion with black lens
- COBTP-ALXT-WH**  
1 meter white aluminum extrusion with white lens
- COBTP-ALXT-L5M-BK**  
5 meter black lens for extrusions
- COBTP-ALXT-L5M-WH**  
5 meter white lens for extrusions
- COBTP-EXT02**  
2" extension with reconnect connectors
- COBTP-EXT24**  
24" extension with reconnect connectors
- COBTP-EXT60**  
60" extension with reconnect connectors
- COBTP-CC06**  
Connection cord for hard-wired driver installation

# SWIVLED



A 5 CCT ultra-slim LED strip can be fixed or directional. Both types of brackets are included, the choice is yours.

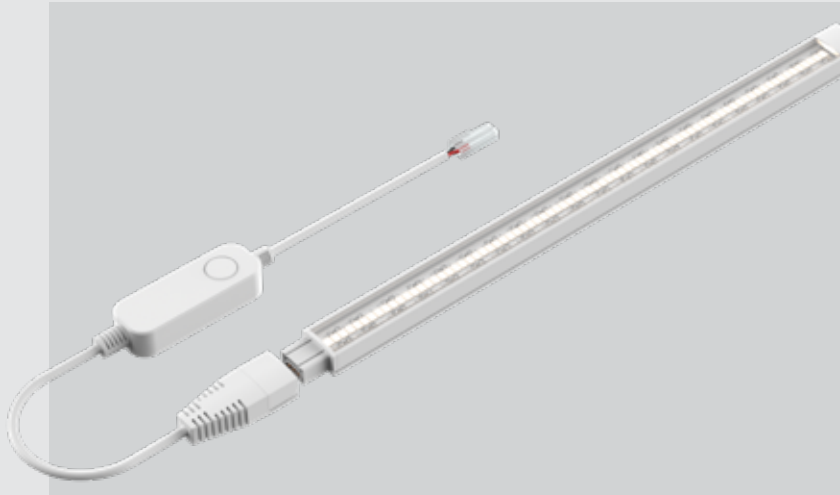

## SWIVLED12-CC

\*Add 12.5" for each additional unit

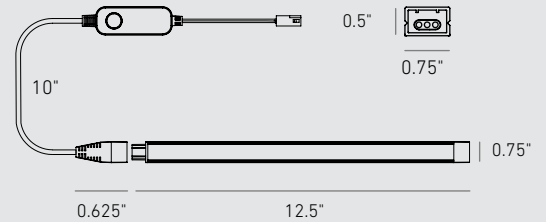

Model	Size	Watts	Delivered lumens	CRI	Color °T	Voltage
SWIVLED12-CC	12.5"	3 W	300 lm	80	2700 K/ 3000 K/ 3500 K/ 4000 K/ 5000 K	12 V

### Specifications

10" (25 cm) power cord with CCT switch included  
 Switch-selectable CCT  
 Multiple fixtures can be linked together (Up to 8x SWIVLED in series)  
 5-year warranty

### Note

Plug-in or hard-wired power supply required for installation. Sold separately.  
 Other color temperatures, finishes, and voltage options are available but may require minimum order quantities (MOQs) and longer lead times. Please contact your DALI representative for more information.

### Finish

**WH** White

### Power supplies: plug-in

**ETR-LED10WPI**  
 12V DC/10W class 2 LED driver  
**ETR-LED24WPI**  
 12V DC/24W class 2 LED driver

### Power supplies: hard-wired

**DD1260**  
 LED driver and dimmer in one unit  
**BT06DIM-IC**  
 6W dimmable LED hardwire driver  
**BT12DIM-IC**  
 12W dimmable LED hardwire driver  
**BT24DIM-IC**  
 24W dimmable LED hardwire driver  
**BT36DIM**  
 36W dimmable LED hardwire driver  
**BT48DIM**  
 48W dimmable LED hardwire driver

### Accessories

**SWIVLEDCC-EXT10**  
 10" extension cord  
**SWIVLEDCC-EXT36**  
 36" extension cord  
**SWIVLEDCC-EXT60**  
 60" interconnection harness  
**SWIVLEDACC-45VCLIP**  
 45 degree mounting brackets  
**SWIVLED-CC10-OUTPUT**  
 10" extension cord with male/female connectors



# SUPER-PUCK RECESSED



Enjoy energy-saving white light in a variety of attractive finishes. These LED pucks are well suited to accent and task lighting under cabinets and in other areas.

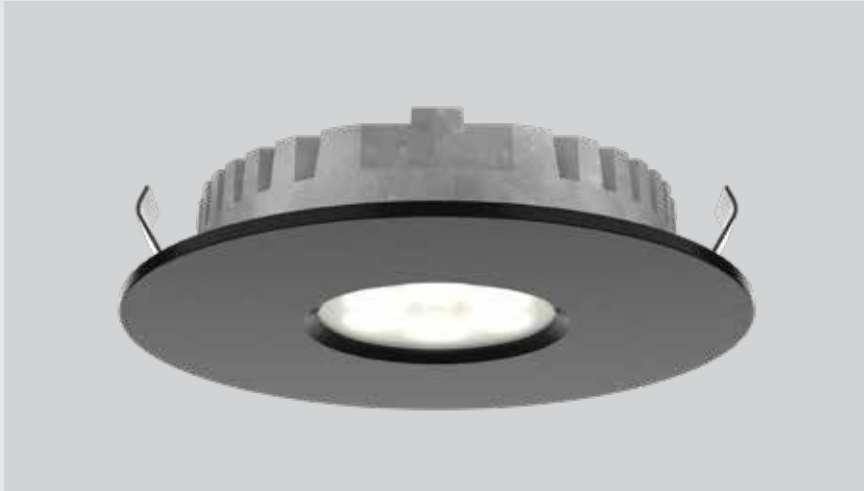

4001-CC

Ø2.375"

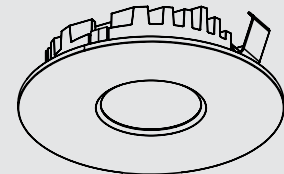

Ø2.625"

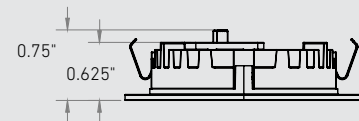

Model	Size	Watts	Delivered lumens	CRI	Color °T	Voltage
4001-CC	Ø2.625"	3 W	150 lm	90	2700, 3000, 3500, 4000, 5000 K	12 V

## Specifications

12V DC LED driver required  
 12" input lead with quick connector  
 24" interconnection harness included  
 Switch-selectable CCT  
 Smooth 360° wide spread  
 5-year warranty

## Power supplies: plug-in

**ETR-LED10WPI**  
 12V DC/10W class 2 LED driver  
**ETR-LED24WPI**  
 12V DC/24W class 2 LED driver

## Power supplies: hard-wired

**DD1260**  
 LED driver and dimmer in one unit  
**BT06DIM-IC**  
 6W dimmable LED hardwire driver  
**BT12DIM-IC**  
 12W dimmable LED hardwire driver  
**BT24DIM-IC**  
 24W dimmable LED hardwire driver  
**BT36DIM**  
 36W dimmable LED hardwire driver  
**BT48DIM**  
 48W dimmable LED hardwire driver

## Finish

- **BK** Black
- **GD** Gold
- **SN** Satin Nickel
- **WH** White

## Accessories

- 4000-E24**  
24" extension cord
- 4000-E60**  
60" extension cord
- 4000HRNS-24**  
24" interconnection harness

## Note

Plug-in or hard-wired power supply required for installation. Sold separately.  
 Other color temperatures, finishes, and voltage options are available but may require minimum order quantities (MOQs) and longer lead times. Please contact your DALI representative for more information.

# DUO-PUCK



These robust LED pucks, equipped with a frosted lens, deliver highly efficient punches of white light, making them well-suited for under-cabinet lighting and various other applications.

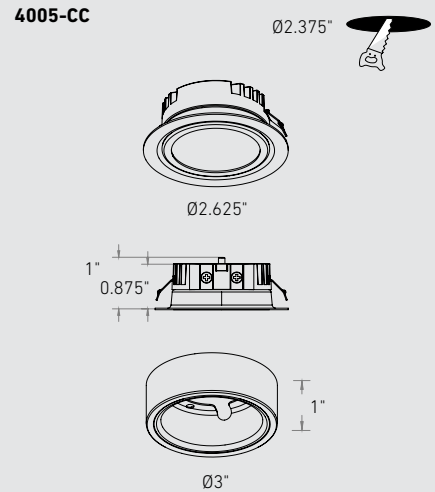

Model	Size	Watts	Delivered lumens	CRI	Color °T	Voltage
<b>4005-CC</b>	Ø2.625"	2 W	138 lm	80	2700 K/ 3000 K/ 3500 K/ 4000 K/ 5000 K	12 V
*Per fixture <b>K4005-CC</b>	Ø2.625"	2 W*	138 lm*			

## Specifications

12V DC LED driver required  
 12" input lead with quick connector  
 24" interconnection harness included  
 Can be recessed or surface mounted  
 Switch-selectable CCT  
 Smooth 360° wide spread  
 Kits available  
 5-year warranty

## Power supplies: plug-in

**ETR-LED10WPI**  
 12V DC/10W class 2 LED driver  
**ETR-LED24WPI**  
 12V DC/24W class 2 LED driver

## Power supplies: hard-wired

**DD1260**  
 LED driver and dimmer in one unit  
**BT06DIM-IC**  
 6W dimmable LED hardwire driver  
**BT12DIM-IC**  
 12W dimmable LED hardwire driver  
**BT24DIM-IC**  
 24W dimmable LED hardwire driver  
**BT36DIM**  
 36W dimmable LED hardwire driver  
**BT48DIM**  
 48W dimmable LED hardwire driver

## Finish

- **BK** Black
- **SN** Satin Nickel
- **WH** White

## Accessories

**4000-E24**  
 24" extension cord  
**4000-E60**  
 60" extension cord  
**4000HRNS-24**  
 24" interconnection harness

## Note

Plug-in or hard-wired power supply required for installation. Sold separately.  
 Other color temperatures, finishes, and voltage options are available but may require minimum order quantities (MOQs) and longer lead times. Please contact your DALs representative for more information.

# MINI-PUCK

Enjoy complete flexibility with our mini LED pucks. Feel free to recess, surface mount, or direct-wire these directional pucks to achieve your desired lighting effect.



LEDRDM1

Ø1.75"

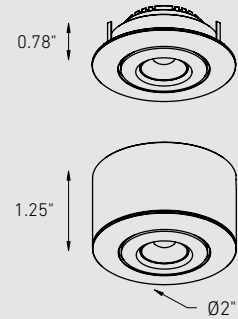

Model	Size	Watts	Delivered lumens	CRI	Color °T	Voltage
LEDRDM1	Ø2"	1.1 W	80 lm	80	3000 K	12 V

## Specifications

- 12V DC LED driver required
- 12" input lead with quick connector
- 24" interconnection harness included
- Smooth 360° wide spread
- Can be recessed or surface mounted
- Surface adapter included
- Gimbal LED module
- 5-year warranty

## Power supplies: plug-in

- ETR-LED10WPI**  
12V DC/10W class 2 LED driver
- ETR-LED24WPI**  
12V DC/24W class 2 LED driver

## Power supplies: hard-wired

- DD1260**  
LED driver and dimmer in one unit
- BT06DIM-IC**  
6W dimmable LED hardwire driver
- BT12DIM-IC**  
12W dimmable LED hardwire driver
- BT24DIM-IC**  
24W dimmable LED hardwire driver
- BT36DIM**  
36W dimmable LED hardwire driver
- BT48DIM**  
48W dimmable LED hardwire driver

## Finish

- BK** Black
- SBA** Sandblasted aluminum
- WH** White

## Accessories

- 4000-E24**  
24" extension cord
- 4000-E60**  
60" extension cord
- 4000HRNS-24**  
24" interconnection harness

## Note

Plug-in or hard-wired power supply required for installation. Sold separately. Other color temperatures, finishes, and voltage options are available but may require minimum order quantities (MOQs) and longer lead times. Please contact your DALs representative for more information.

# ECO-PUCK

The sleek design of this LED puck makes it the ideal choice for cabinet and kitchen lighting applications. It can be dimmed to create just the right ambiance for your decor.



**LEDRDP18**

Ø2.5"



7/16"

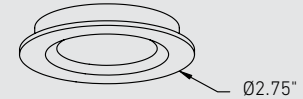

Ø2.75"

5/8"

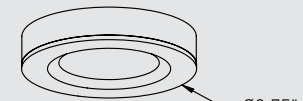

Ø2.75"

Model	Size	Watts	Delivered lumens	CRI	Color °T	Voltage
LEDRDP18	Ø2.75"	1.7 W	100 lm	80	3000 K	12 V

## Specifications

- 12V DC LED driver required
- 12" input lead with quick connector
- 24" interconnection harness included
- Recessed or surface mounted installation
- Surface adapter included
- Smooth 360° wide spread
- 5-year warranty

## Power supplies: plug-in

- ETR-LED10WPI**  
12V DC/10W class 2 LED driver
- ETR-LED24WPI**  
12V DC/24W class 2 LED driver

## Power supplies: hard-wired

- DD1260**  
LED driver and dimmer in one unit
- BT06DIM-IC**  
6W dimmable LED hardwire driver
- BT12DIM-IC**  
12W dimmable LED hardwire driver
- BT24DIM-IC**  
24W dimmable LED hardwire driver
- BT36DIM**  
36W dimmable LED hardwire driver
- BT48DIM**  
48W dimmable LED hardwire driver

## Finish

- WH** White

## Accessories

- 4000-E24**  
24" extension cord
- 4000-E60**  
60" extension cord
- 4000HRNS-24**  
24" interconnection harness

## Note

Plug-in or hard-wired power supply required for installation. Sold separately. Other color temperatures, finishes, and voltage options are available but may require minimum order quantities (MOQs) and longer lead times. Please contact your DALI representative for more information.

# SLIDE

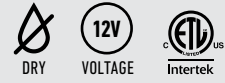

Replace your 12V driver with this 12V dimmer switch with an integrated driver to control the brightness of your low voltage lights. Connect this unit to your 120V input current, and all your lights will dim to a nice, soft glow.

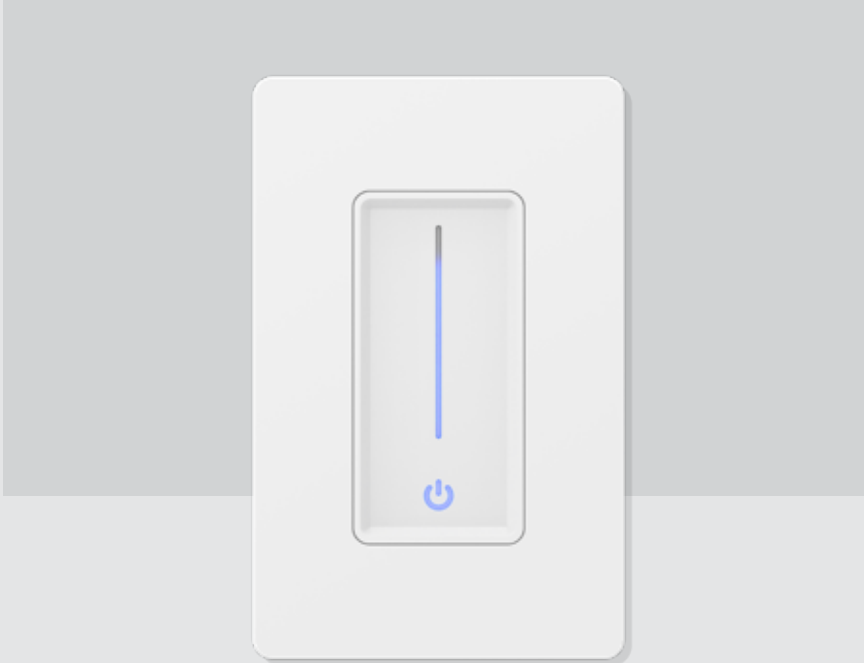

**DD1260**

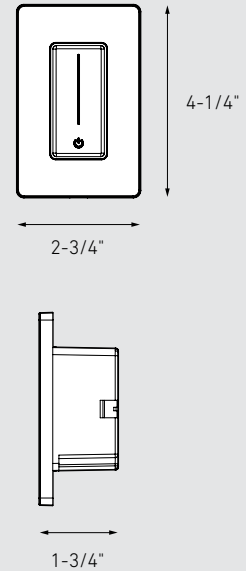

Model	Size	Dimmer	Switch	Minimum load	Maximum load	Input voltage	Output voltage
DD1260	4-1/4"	✓	✓	5 W	60 W	120 VAC	12 VDC

## Specifications

LED driver and dimmer in one unit  
 Indoor use only  
 Input: 120 VAC ~ 1.0 A, 60 Hz  
 Dimming range: 100% - 10%  
 Dimming type: TRIAC edge cut  
 Fits in a standard electrical box  
 Single pole  
 Works with all dimmable 12V lights  
 5-year warranty

## Finish

**WH** White

## Note

Does not work with Dals smart lights.  
 Requires a neutral wire. Works in a single-pole setup only.

NEW

# 24V COB TAPE

Our 24V COB tape light with 5 CCT adjustability delivers a smooth, dot-free glow, five versatile color temperature options, and minimized voltage drop for consistent performance in any space or ambiance.

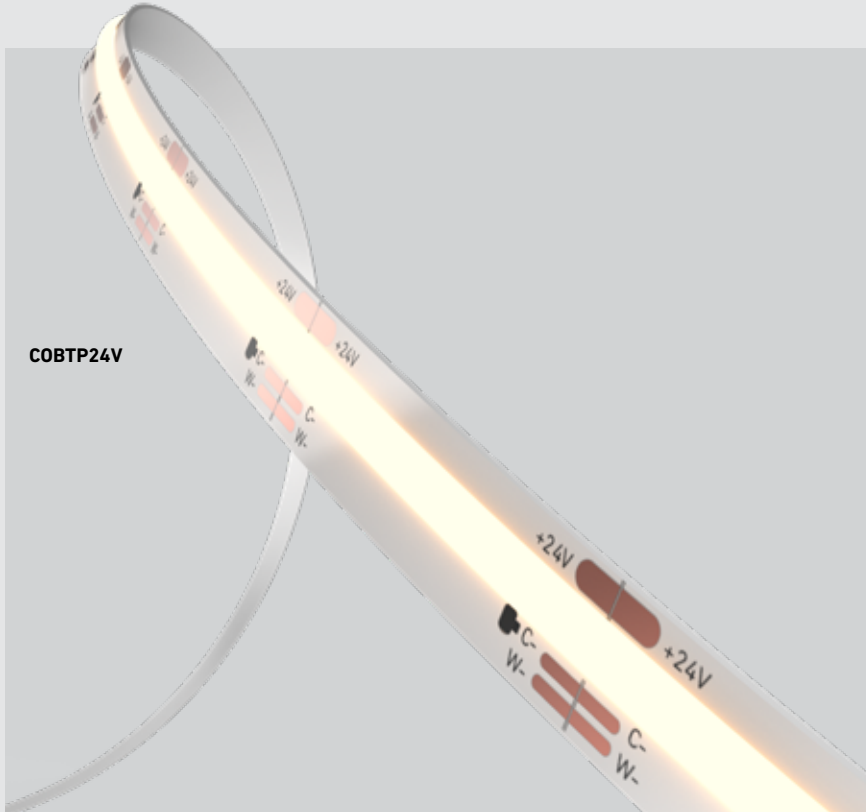
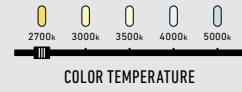

COBTP24V

Model	Size	Watts	Delivered lumens	CRI	Color °T	Voltage
COBTP24V-K10FT-CC	10' (3m)	18 W	1590 lm	90	2700 K/ 3000 K/ 3500 K/ 4000 K/ 5000 K	24 V
COBTP24V-K20FT-CC	20' (6m)	36 W	3180 lm			
COBTP24V-R50FT-CC*	50' (15m)	1.8 W /foot	160 lm /foot			
COBTP24V-R100FT-CC*	100' (30m)	1.8 W /foot	160 lm /foot			

\*50m and 100m 24V COB reels do not include a driver.  
Plug-in or hard-wired power supply required for installation. Sold separately.

<b>COBTP24V-K10FT-CC</b>	1 x 10' (3m) kit
<b>COBTP24V-K20FT-CC</b>	1 x 20' (6m) kit
<b>COBTP24V-R50FT-CC</b>	1 x 50' (15m)
Reel only, driver not included	
<b>COBTP24V-R100FT-CC</b>	1 x 100' (30m)
Reel only, driver not included	

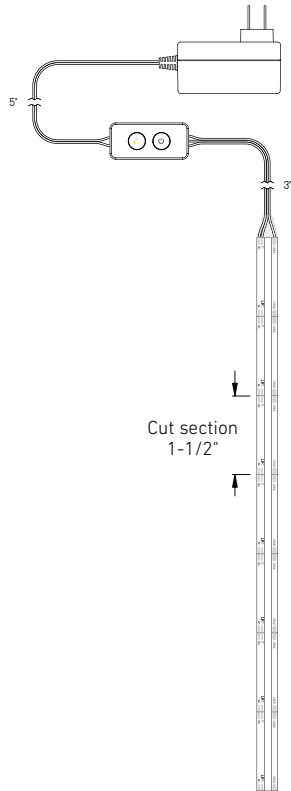

## Specifications

24V DC LED plug-in driver included for 10- and 20-foot kits only (10 feet = 30W / 20 feet = 60W)

Seamless light emission (190 LEDs/foot)

Includes a wired remote with selectable CCT and on/off functionality for 10- and 20-foot kits only

Quick-connect assembly for easy installation

Self adhesive

Can be cut at every cut mark (every 1-1/2")

Maximum run of 40 feet

5-year warranty

## Power supplies: plug-in

### COBTP24V-ETR30

24V DC/30W class 2 LED driver

### COBTP24V-ETR60

24V DC/60W class 2 LED driver

## Power supplies: hard-wired

### DR2412DIM

12W 24V dimmable hardwired driver

### DR2424DIM

24W 24V dimmable hardwired driver

### DR2448DIM

48W 24V dimmable hardwired driver

### DR2460DIM

60W 24V dimmable hardwired driver

### DR2496DIM

96W 24V dimmable hardwired driver

## Accessories

### COBTP24V-ACCI

I-shaped connector (strip-to-strip)

### COBTP24V-ACCL

L-shaped connector (strip-to-strip)

### COBTP24V-EXT24

24" extension cable

### COBTP24V-EXT60

60" extension cable

### COBTP24V-EXT120

120" extension cable

### COBTP24V-CC36

36" extension cable (strip-to-controller)

### COBTP24V-SWT

CCT controller with on/off functionality

### COBTP-ALXT-L5M-BK

5 meter black lens for extrusions

### COBTP-ALXT-L5M-WH

5 meter white lens for extrusions

# POWERLED PUCK



Simplifying life for our customers is always a priority for us. With a direct 120V driverless connection, we have achieved our goal with our PowerLED pucks.

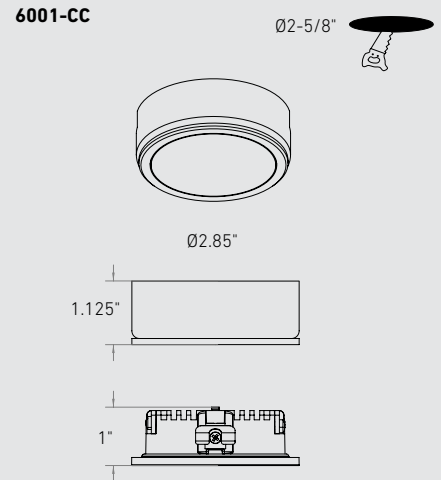



Model	Size	Watts	Delivered lumens	CRI	Color °T	Voltage
6001-CC	Ø2.875"	4 W	235 lm	90	2700, 3000, 3500, 4000, 5000 K	120 V

## Specifications

- 12" input and output lead with quick connector
- Can be hardwired to a junction box
- Can be interconnected
- Switch-selectable CCT
- Recessed or surface mounted installation
- Surface adapter included
- Smooth 360° wide spread
- Aluminum construction
- 5-year warranty

## Finish

-  **BK** Black
-  **SN** Satin Nickel
-  **WH** White

## Accessories

- 6000-JB**  
Junction box for 120 V series with one 12" extension cord
- 6001-PC**  
72" power cord
- 6001-E24**  
24" extension cord
- 6001-E60**  
60" extension cord

## Note

Junction box model 6000-JB or power cord model 6001-PC are required for installation. Sold separately.

Other color temperatures, finishes, and voltage options are available but may require minimum order quantities (MOQs) and longer lead times. Please contact your DALs representative for more information.



# POWERLED LINEAR



Long runs and flexibility are the primary features of our smooth PowerLED linears. A sleek, driverless connection ensures smooth and continuous light in every application.



**6009CC**

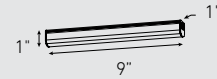

**6012CC**

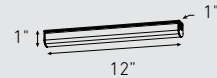

**6024CC**

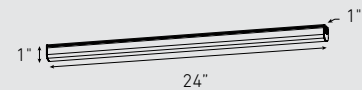

**6036CC**

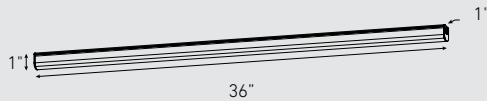

**6048CC**

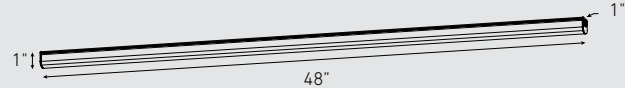

Model	Size	Watts	Delivered lumens	CRI	Color °T	Voltage
<b>6009CC</b>	9"	3 W	250 lm	80	2700 K/ 3000 K/ 3500 K/ 4000 K/ 5000 K	120 V
<b>6012CC</b>	12"	4 W	330 lm			
<b>6024CC</b>	24"	8 W	675 lm			
<b>6036CC</b>	36"	12 W	1080 lm			
<b>6048CC</b>	48"	16 W	1300 lm			

## Specifications

- Switch-selectable CCT
- Dimmable with regular low-voltage electronic dimmers
- Smooth linear wide spread
- Multiple fixtures can be linked together (up to 200W)
- 5-year warranty

## Finish

- SBA** Sandblasted aluminum

## Note

Junction box model 6000-JB or power cord model 6000-ACCPC are required for installation. Sold separately.

Other color temperatures, finishes, and voltage options are available but may require minimum order quantities (MOQs) and longer lead times. Please contact your DALs representative for more information.

## Accessories

- 6000-ACCE06**  
6" extension cord
- 6000-ACCE24**  
24" extension cord
- 6000-ACCE60**  
60" extension cord
- 6000-ACCLR**  
Kit of left and right L connectors
- 6000-ACCPC**  
6' power cord
- 6000-JB**  
Junction box

# PROLED LINEAR

Everyone loves simplicity. That is exactly what you get when ordering this linear design. All accessories are included, and the ease of installation make it the right choice for your project.



3000k  
COLOR TEMPERATURE



DAMP



VOLTAGE



Model	Size	Watts	Delivered lumens	CRI	Color °T	Voltage
HLF09-3K	9"	3 W	200 lm	90	3000 K	120 V
HLF12-3K	12"	4 W	380 lm			
HLF18-3K	18"	8 W	675 lm			
HLF24-3K	24"	12 W	900 lm			
HLF30-3K	30"	16 W	1100 lm			

---

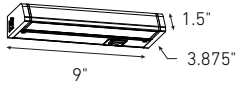
**HLF09**

---

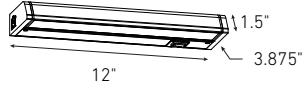
**HLF12**

---

**HLF18**

---

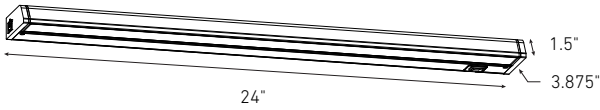
**HLF24**

---

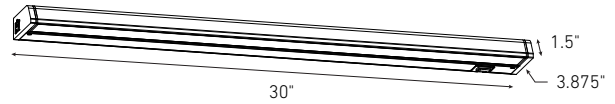
**HLF30**

---

**Specifications**

120 V direct connection or plug-in  
Dimmable with regular low-voltage electronic dimmers  
Interconnectable  
Robust construction

**Note**

Other color temperatures, finishes, and voltage options are available but may require minimum order quantities (MOQs) and longer lead times. Please contact your DALI representative for more information.

---

**Finish**

**WH** White

---

**Accessories**

**9000-ACCE24**  
24" extension cord  
**9000-ACCE72**  
72" extension cord

# COUNTERLED LINEAR

When designing a linear, we always want our customers to have flexibility at their fingertips. This has become a reality with our CCT linear, as the toggle switch gives you the ability to choose between three color temperatures.

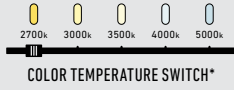

Model	Size	Watts	Delivered lumens	CRI	Color °T	Voltage
9009CC-WH*	9"	3.5 W	200 lm	90	2700 K/ 3000 K/ 4000 K	120 V
9012CC-WH	12"	4 W	335 lm		2700 K/ 3000 K/ 3500 K/ 4000 K/ 5000 K	
9018CC-WH	18"	8 W	560 lm			
9024CC-WH	24"	12 W	850 lm			
9030CC-WH	30"	16 W	1115 lm			

\*Model 9009CC is plug-in only and comes with three selectable CCTs: 2700K, 3000K, 4000K

---

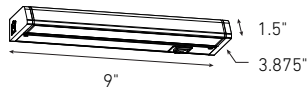
**9009CC-WH**

---

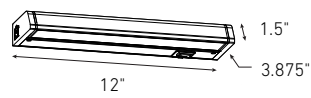
**9012CC-WH**

---

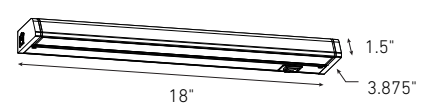
**9018CC-WH**

---

**9024CC-WH**

---

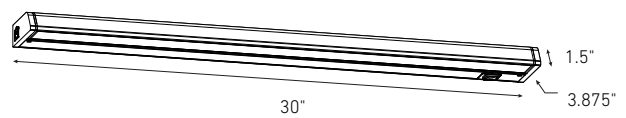
**9030CC-WH**

---

**Specifications**

Switch-selectable CCT  
120 V direct connection or plug-in\*  
Dimmable with regular low-voltage electronic dimmers  
Interconnectable  
5-year warranty

---

**Finish**

**WH** White

---

**Note**

Other color temperatures, finishes, and voltage options are available but may require minimum order quantities (MOQs) and longer lead times. Please contact your DALI representative for more information.

---

**Accessories**

**9000-ACCE24**  
24" extension cord  
**9000-ACCE72**  
72" extension cord

NEW

# LED DIMMABLE DRIVERS

Dimming is seamlessly integrated with our LED Dimmable Driver series, enabling precise control over light output. These drivers allow for optimal adjustment, ensuring the ideal lighting level based on the time of day and usage requirements of your fixtures.



IC\*  
RATED



DR2496DIM



BT12DIM-IC

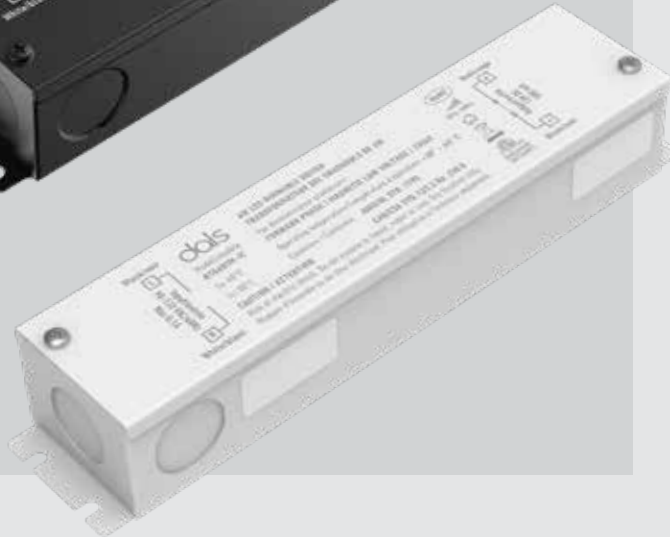

Model	Watts	Input voltage	Output voltage	Model	Watts	Input voltage	Output voltage
BT06DIM-IC*	6 W	100VAC-230VAC, 50/60Hz	12 VDC	DR2412DIM	12 W	100VAC-230VAC, 50/60Hz	24 VDC
BT12DIM-IC*	12 W			DR2424DIM	24 W		
BT24DIM-IC*	24 W			DR2448DIM	48 W		
BT36DIM	36 W			DR2460DIM	60 W		
BT48DIM	48 W			DR2496DIM	96 W		

\*IC rated

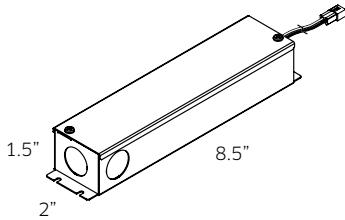
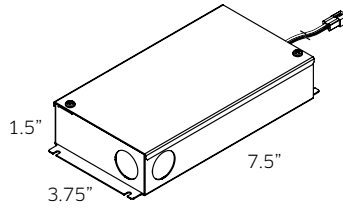
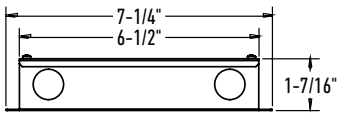
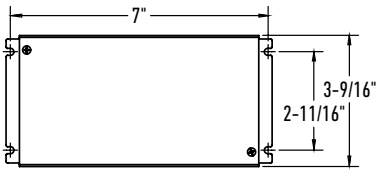
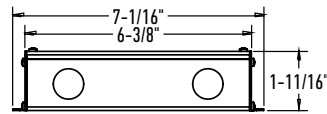
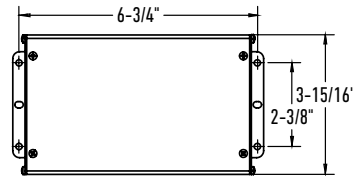
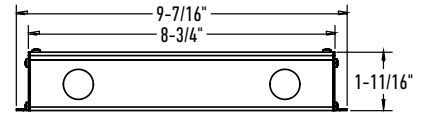
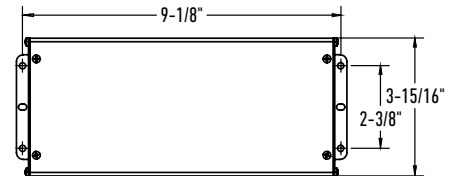
**BT06DIM-IC / BT12DIM-IC****BT24DIM-IC / BT36DIM / BT48DIM****DR2412DIM / DR2424DIM / DR2448DIM****DR2460DIM****DR2496DIM****12V Specifications**

Constant voltage mode power supply  
 AC-dimming supply  
 (with TRIAC or ELV dimmer)  
 Protection: short circuit / Over voltage  
 Integrated junction box for  
 hard-wire installation  
 Fully isolated metal case -  
 Cooling by air convection  
 Optimal dimming when used at 50%  
 or more of total load  
 Load Range: 50% to 100%  
 Operating temperature: -30°C to 45°C  
 5-year warranty

**24V Specifications**







Constant voltage mode power supply  
 DC-dimming supply  
 (with TRIAC or ELV dimmer)  
 Protection: short circuit / Over voltage  
 Integrated junction box for  
 hard-wire installation  
 Fully isolated metal case -  
 Cooling by air convection  
 Optimal dimming when used at 50%  
 or more of total load  
 Load Range: 50% to 100%  
 5-year warranty

**Finish**

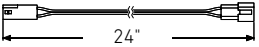
- **BK** Black (24V models)
- **WH** White (12V models)

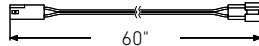

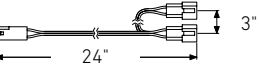

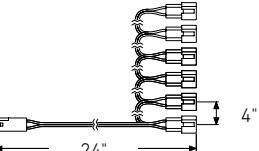







# ACCESSORIES

## 12V GENERAL ACCESSORIES

Title		Model	Finish	Specification
<b>LED EXTENSION ACCESSORY</b>  <small>DRY</small>		4000-E24	Black	<ul style="list-style-type: none"> <li>• 24" extension cord for 12 V LED products</li> <li>• Quick-connect installation</li> </ul>
<b>LED EXTENSION ACCESSORY</b>  <small>DRY</small>		4000-E60	Black	<ul style="list-style-type: none"> <li>• 60" extension cord for 12 V LED products</li> <li>• Quick-connect installation</li> </ul>
<b>LED HARNESS ACCESSORY</b>  <small>DRY</small>		4000HRNS-24	Black	<ul style="list-style-type: none"> <li>• 24" interconnection harness for 12 V LED products</li> <li>• Quick-connect installation</li> </ul>
<b>LED HARNESS ACCESSORY</b>  <small>DRY</small>		LEDHRNS-6	Black	<ul style="list-style-type: none"> <li>• 24" 6 direction interconnection harness for 12 V LED products</li> <li>• Quick-connect installation</li> </ul>









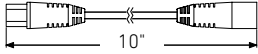

## 12V 3000K COB-TAPE ACCESSORIES

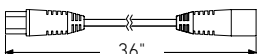

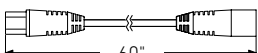

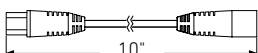

		Model	Finish	Specifications
<p><b>EXTRUSIONS</b></p> 		COBTP-ALXT-BK COBTP-ALXT-WH	Black White	<ul style="list-style-type: none"> <li>• 1 meter black aluminum extrusion with black lens</li> <li>• 1 meter white aluminum extrusion with white lens</li> </ul>
<p><b>EXTRUSIONS</b></p> 		COBTP-ALXT-L5M-BK COBTP-ALXT-L5M-WH	Black White	<ul style="list-style-type: none"> <li>• 5 meter roll of black aluminum extrusion with black lens</li> <li>• 5 meter roll of white aluminum extrusion with white lens</li> </ul>
<p><b>COB-TAPE EXTENSION CORD</b></p> 		COBTP-CC06	White	<ul style="list-style-type: none"> <li>• 6 in. connection cord for hard-wired driver installation for COB tape</li> </ul>
<p><b>COB-TAPE EXTENSION CORD</b></p> 		COBTP-EXT02	White	<ul style="list-style-type: none"> <li>• 2 in. extension cord with reconnect connectors for COB tape</li> </ul>
<p><b>COB-TAPE EXTENSION CORD</b></p> 		COBTP-EXT24	White	<ul style="list-style-type: none"> <li>• 24 in. extension cord with reconnect connectors for COB tape</li> </ul>
<p><b>COB-TAPE EXTENSION CORD</b></p> 		COBTP-EXT60	White	<ul style="list-style-type: none"> <li>• 60 in. extension cord with reconnect connectors for COB tape</li> </ul>

# ACCESSORIES

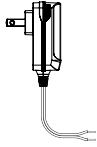
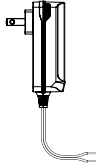
## 12V SWIVLED ACCESSORIES

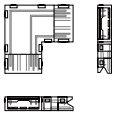

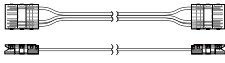
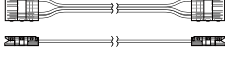
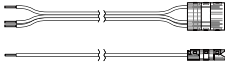



		Model	Finish	Specifications
<b>SWIVLED EXTENSION CORD</b> 		SWIVLEDCC-EXT10	White	<ul style="list-style-type: none"> <li>• 10" extension cord for SwivLED series</li> <li>• One end with male connector and one end with female connector</li> <li>• Can be connected together</li> <li>• Quick-connect installation</li> </ul>
<b>SWIVLED EXTENSION CORD</b> 		SWIVLEDCC-EXT36	White	<ul style="list-style-type: none"> <li>• 36" extension cord for SwivLED series strips</li> <li>• One end with male connector and one end with female connector</li> <li>• Can be connected together</li> <li>• Quick-connect installation</li> </ul>
<b>SWIVLED EXTENSION CORD</b> 		SWIVLEDCC-EXT60	White	<ul style="list-style-type: none"> <li>• 60" extension cord for SwivLED series strips</li> <li>• One end with male connector and one end with female connector</li> <li>• Can be connected together</li> <li>• Quick-connect installation</li> </ul>
<b>SWIVLED MOUNTING BRACKETS</b> 		SWIVLEDACC-45VCLIP	Chrome	<ul style="list-style-type: none"> <li>• 45 Degree Brackets for SwivLED Series</li> </ul>
<b>SWIVLED CONNECTION ACCESSORY</b> 		SWIVLED-CC10-OUTPUT	White	<ul style="list-style-type: none"> <li>• 10" extension cord for SwivLED series</li> <li>• One end with male connector and one end with female connector</li> <li>• Can be connected together</li> <li>• Quick-connect installation</li> </ul>

## 24V 5CCT COB-TAPE ACCESSORIES

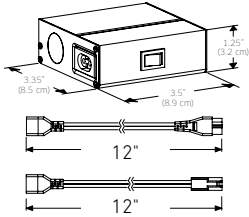

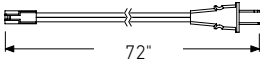

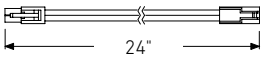

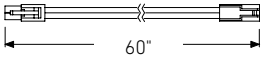



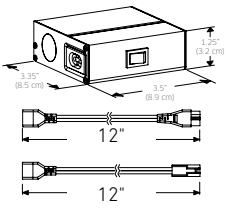

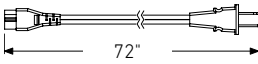

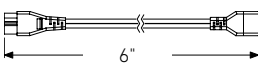
		Model	Finish	Specifications
<b>EXTRUSIONS</b>		COBTP-ALXT-BK COBTP-ALXT-WH	Black White	<ul style="list-style-type: none"> <li>• 1 meter black aluminum extrusion with black lens</li> <li>• 1 meter white aluminum extrusion with white lens</li> </ul>
<b>30W 24V COB-TAPE PLUG-IN DRIVER</b>		COBTP24V-ETR30	White	<ul style="list-style-type: none"> <li>• 30W Plug-in driver for 24V COB tape</li> </ul>
<b>60W 24V COB-TAPE PLUG-IN DRIVER</b>		COBTP24V-ETR60	White	<ul style="list-style-type: none"> <li>• 60W Plug-in driver for 24V COB tape</li> </ul>
<b>COB-TAPE I-CONNECTOR</b>		COBTP24V-ACCI	White	<ul style="list-style-type: none"> <li>• I-shaped connector (strip-to-strip)</li> </ul>
<b>COB-TAPE L-CONNECTOR</b>		COBTP24V-ACCL	White	<ul style="list-style-type: none"> <li>• L-shaped connector (strip-to-strip)</li> </ul>
<b>COB-TAPE EXTENSION CABLE</b>		COBTP24V-EXT24	White	<ul style="list-style-type: none"> <li>• 24" extension cable</li> </ul>
<b>COB-TAPE EXTENSION CABLE</b>		COBTP24V-EXT60	White	<ul style="list-style-type: none"> <li>• 60" extension cable</li> </ul>
<b>COB-TAPE EXTENSION CABLE</b>		COBTP24V-EXT120	White	<ul style="list-style-type: none"> <li>• 120" extension cable</li> </ul>
<b>COB-TAPE CABLE FOR CONTROLLER</b>		COBTP24V-CC36	White	<ul style="list-style-type: none"> <li>• 36" extension cable (strip-to-controller)</li> </ul>
<b>COB-TAPE CCT CONTROLLER</b>		COBTP24V-SWT	White	<ul style="list-style-type: none"> <li>• CCT controller</li> </ul>

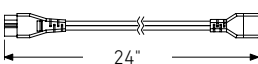
# 120V ACCESSORIES

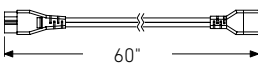
## 120V POWERLED PUCK ACCESSORIES

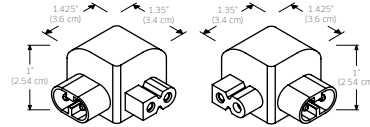
Model		Compatibility	Finish	Specification
<b>6000-JB</b>  DRY		6001	White	<ul style="list-style-type: none"> <li>• Hardwire junction box for PowerLed pucks and linears series</li> <li>• Quick-connect installation</li> <li>• Allows hard-wired 120V setup</li> </ul>
<b>6001-PC</b>  DRY		6001	White	<ul style="list-style-type: none"> <li>• 72" power cord for PowerLed pucks</li> <li>• On/off switch on cord</li> <li>• Quick-connect installation</li> <li>• Plug-in version</li> </ul>
<b>6001-E24</b>  DRY		6001	White	<ul style="list-style-type: none"> <li>• 24" extension cord for PowerLed pucks series</li> <li>• One end with male connector and one end with female connector</li> <li>• Quick-connect installation</li> </ul>
<b>6001-E60</b>  DRY		6001	White	<ul style="list-style-type: none"> <li>• 60" extension cord for PowerLed pucks series</li> <li>• One end with male connector and one end with female connector</li> <li>• Quick-connect installation</li> </ul>

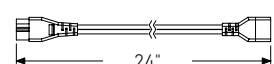
## 120V LINEAR ACCESSORIES

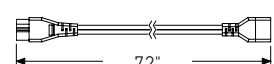
Model	Compatibility	Finish	Specification
<b>6000-JB</b> 		6009CC 6012CC 6024CC 6036CC 6048CC	White <ul style="list-style-type: none"> <li>• Hardwire junction box for PowerLED pucks and linears series</li> <li>• Quick-connect installation</li> <li>• Allows hard-wired 120V setup</li> </ul>
<b>6000-ACCPC</b> 		6009CC 6012CC 6024CC 6036CC 6048CC	White <ul style="list-style-type: none"> <li>• 72" power cord for PowerLED linear series</li> <li>• On/off switch on cord</li> <li>• Quick-connect installation</li> <li>• Plug-in version</li> </ul>
<b>6000-ACCE06</b> 		6009CC 6012CC 6024CC 6036CC 6048CC	White <ul style="list-style-type: none"> <li>• 6" extension cord for PowerLED linear series</li> <li>• One end with male connector and one end with female connector</li> <li>• Quick-connect installation</li> </ul>
<b>6000-ACCE24</b> 		6009CC 6012CC 6024CC 6036CC 6048CC	White <ul style="list-style-type: none"> <li>• 24" extension cord for PowerLED linear series</li> <li>• One end with male connector and one end with female connector</li> <li>• Quick-connect installation</li> </ul>
<b>6000-ACCE60</b> 		6009CC 6012CC 6024CC 6036CC 6048CC	White <ul style="list-style-type: none"> <li>• 60" extension cord for PowerLED linear series</li> <li>• One end with male connector and one end with female connector</li> <li>• Quick-connect installation</li> </ul>
<b>6000-ACCLR</b> 		6009CC 6012CC 6024CC 6036CC 6048CC	White <ul style="list-style-type: none"> <li>• Kit of left and right L connectors</li> </ul>
<b>9000-ACCE24</b> 		9009CC HLF09 9012CC HLF12 9018CC HLF18 9024CC HLF24 9030CC HLF30	White <ul style="list-style-type: none"> <li>• 24" extension cord for 9000 and HLF linear series</li> <li>• One end with male connector and one end with female connector</li> <li>• Quick-connect installation</li> </ul>
<b>9000-ACCE72</b> 		9009CC HLF09 9012CC HLF12 9018CC HLF18 9024CC HLF24 9030CC HLF30	White <ul style="list-style-type: none"> <li>• 72" extension cord for 9000 and HLF linear series</li> <li>• One end with male connector and one end with female connector</li> <li>• Quick-connect installation</li> </ul>





FORMS



118  
NAPA  
NAPF20-CC



120  
IRIS  
IRPD-CC



122  
QUARTET  
CAPD72-CC



124  
BOULEVARD PENDANT  
LNPD48-CC  
LNPDSC48-CC



126  
PINPOINT  
MSLPD48-CC



128  
BEAM  
SPD48-CC  
SPD72-CC

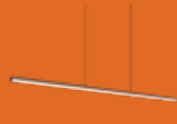

132  
CURRENT  
SLPD60-CC



134  
SWAY ONE  
W1PD48-CC



134  
SWAY THREE  
W3PD36-CC



136  
SPIN  
BRPD40-CC



136  
SPIN  
BRPD18-CC



138  
OLYMPIA FIVE  
RRPD5-CC



138  
OLYMPIA TWO  
RRPD2-CC



140  
HELIX  
SPR20-CC  
SPR34-CC



142  
TWIST  
TWPS-3K



144  
TWIRL  
TWPD-CC

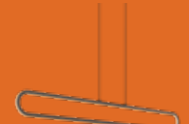

146  
ATOM PENDANT  
FPD60-CC



146  
ATOM ONE  
FPD-CC



146  
ATOM THREE  
FPDC3-CC



148  
CIRCA  
RGPD24-CC



150  
ECLIPSE  
PDR14-CC



152  
PYRA  
TRPD34-CC



154  
DROP  
CFPD20-CC



158  
ASTERISK  
SSPD32-CC



160  
STELLAR PENDANT  
STRPD-3K



164  
NOVA  
PDC18-CC



166  
CHANNEL PENDANT  
PDLED120-  
24/36 /48/60  
5/5SQ/8/8SQ



124  
BOULEVARD FLUSH  
MOUNT  
LNFM48-CC



168  
FOCUS  
CYL05-CC  
CYL06-CC-V





118

NAPA  
NAPF20-CC



146

ATOM  
FDB-CC



158

ASTERISK FLUSH  
MOUNT  
SSF20-CC



160

STELLAR  
FLUSH MOUNT  
STRFM-3K



134

SWAY FLUSH MOUNT  
W3FM-CC



170

HOVER  
CCFM-CC



172

NEWTON  
FMT18-CC



152

PYRA FLUSH MOUNT  
TRFM22-CC



174

MISTY  
FUZ11-CC



176

AURORA  
CFH12-CC



178

ORA  
CFG13-C



180

FUSION  
TLFM12-CC  
TLFM21-CC



182

DELTA  
CFLEDR 6/10/14/18/24-CC  
CFLEDSQ6/10/14-CC



186

RADIANCE  
FMM09-CC  
FMM12-CC



188

PRIME  
FMP05-CC  
FMP05M-CC  
FMP09/12-CC



190

SHIFT  
VA032-CC  
VA024-CC



192

LEDGE  
VAL24-CC  
VAL36-CC



194

BALANCE  
VCC24-CC  
VCC36-CC



136

SPIN SCONCE  
BRV24-CC  
BRV36-CC



196

LIGHTNING  
VDL40-CC



198

ARIA  
VSW24-CC  
VSW36-CC



200

NOBLE ONE  
LEDVAN001-CC-18  
LEDVAN001-CC-24



202

NOBLE TWO  
LEDVAN002-CC-24  
LEDVAN002-CC-36



204

LYRA  
LEDVAN003-CC-24  
LEDVAN003-CC-32



206

PORTRAIT  
VLG24-CC  
VLG36-CC



160

STELLAR  
STK21-CC  
STK37-CC



208

GEMINI  
SWS24-CC  
SWS36-CC  
SWS48-CC  
SWS60-CC



210

MIDNIGHT  
RWS24-CC  
RWS48-CC  
RWS60-CC



214

PROFILE  
LWJ08-CC  
LWJ16-CC  
LWJ24-CC



126

PINPOINT WALL  
MSLWALL-CC



216  
ADEN  
LEDWALL-A



218  
BROOKLYN  
LEDWALL-B



220  
EDINBURGH  
LEDWALL-E



222  
SHIELD  
DSWC05-CC  
DSWC07-CC-V



224  
GENEVA  
LEDWALL-G-CC



226  
HARLOW  
LEDWALL-H



228  
ALTO  
SQS06/10/15



230  
CUBIX  
LEDWALL001D



232  
RISE  
LSTP12-CC



228  
ALTO STEP LIGHT  
SQSTP-CC



234  
ECHO  
LEDSTEP002D-CC



236  
PEARL  
LEDSTEP004D-CC



238  
CAMBER  
LEDSTEP005D-CC



240  
ASCEND  
LSTP07-CC



250  
GLAM  
RTL-3C



160  
STELLAR FLOOR  
STRFL-3K



242  
ACCESSORIES



NEW

# NAPA

The versatile Napa fixture features a timeless dome-shaped design and the flexibility to be mounted as either a pendant or a sleek ceiling flush mount. Its unique internal dome lens hides the light source, delivering a soft, gradient glow without glare.

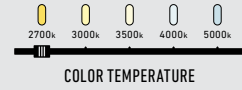

DAMP



LOW-GLARE

**T24  
JA8**  
CERTIFIED



NAPF20-CC



### Quick-Connect

Pendant with Quick-Connect stems for effortless installation. No wires—just screw in the desired length directly to the canopy.



Model	Size	Watts	Delivered lumens	CRI	Color °T	Voltage
NAPF20-CC	20"	40 W	1825 lm	80	2700, 3000, 3500, 4000, 5000 K	120 V



## NAPF20-CC

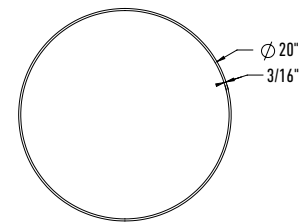
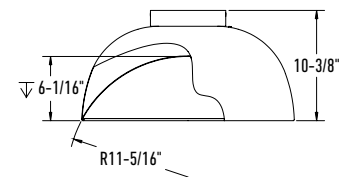
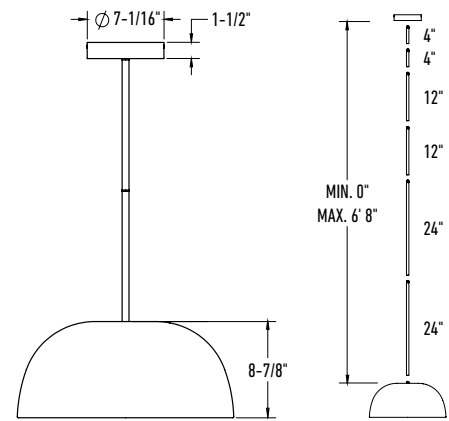

### Specifications

Can be mounted as either a pendant or a ceiling flush mount  
 Unique internal dome lens hides the light source, delivering a soft, gradient glow.  
 Adjustable height up to 6'-8" with quick connect stems  
 Switch-selectable CCT  
 Integrated dimmable driver  
 Canopy mount on 4" octagon junction box  
 5-year warranty

### Finish

- **BK** Black
- **WH** White

### Note

Other color temperatures, finishes, and voltage options are available but may require minimum order quantities (MOQs) and longer lead times. Please contact your DALs representative for more information.

NEW

# IRIS

Add a touch of elegance to any room with our 9-inch Iris pendant, featuring a sleek glass dome and the innovative Gravity Glide feature for effortless height adjustment. Available in multiple finishes, it's perfect for creating a sophisticated ambiance at home or in any professional setting.

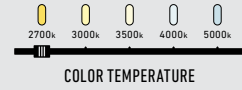

COLOR TEMPERATURE



DRY



GRAVITY GLIDE



IRPD-CC

Model	Size	Watts	Delivered lumens	CRI	Color °T	Voltage
IRPD-CC	9"	12 W	760 lm	90	2700, 3000, 3500, 4000, 5000 K	120 V

## IRPD-CC

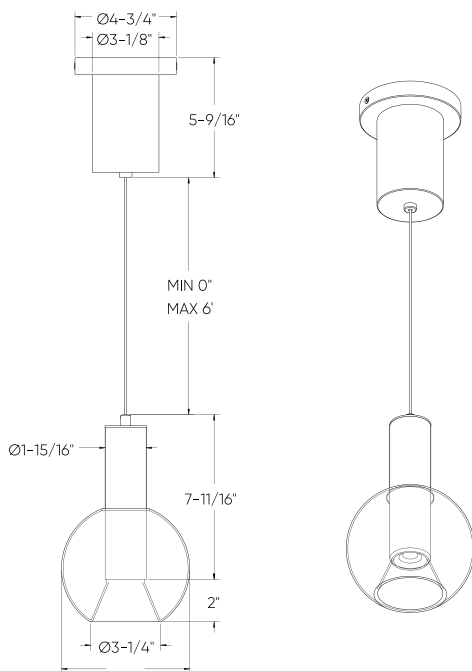

### Specifications

Adjustable height up to 6 feet  
Gravity Glide height adjustment allows you to effortlessly adjust the height of a pendant lamp by simply pulling or pushing the cord.  
Switch-selectable CCT  
Integrated dimmable driver  
Canopy mount on 4" octagon junction box  
5-year warranty

### Finish

- **BK** Black
- **GD** Gold
- **WH** White

### Note

Other color temperatures, finishes, and voltage options are available but may require minimum order quantities (MOQs) and longer lead times. Please contact your DALs representative for more information.

NEW

# QUARTET

Explore the sophisticated design and versatile functionality of our Quartet pendant, featuring swiveling heads that efficiently direct light in both residential and commercial environments.

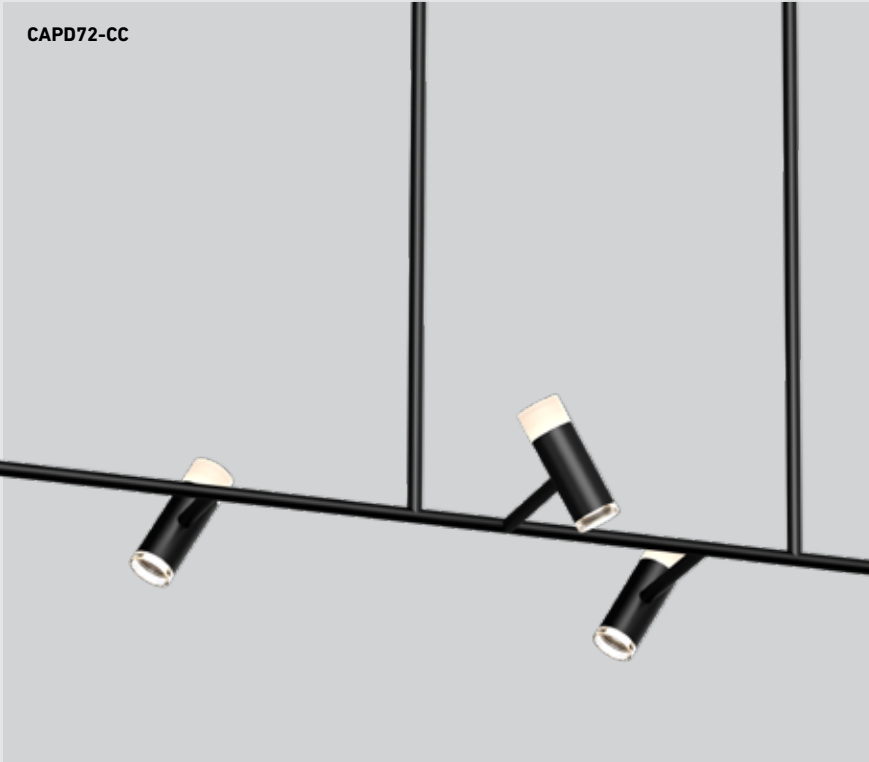
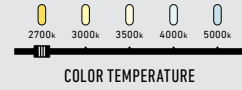

Model	Size	Watts	Delivered lumens	CRI	Color °T	Voltage
CAPD72-CC	72"	30 W	2400 lm	80	2700, 3000, 3500, 4000, 5000 K	120 V





**CAPD72-CC**

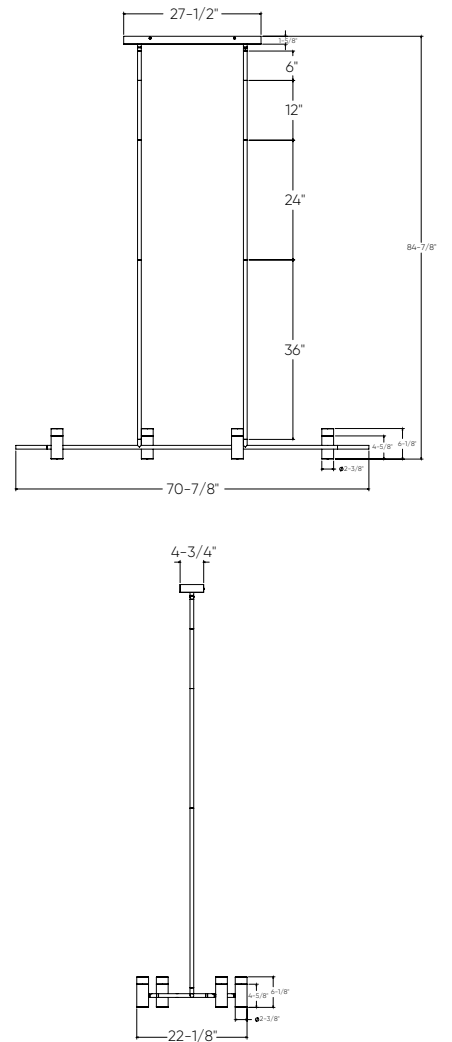

**Specifications**

Four 1/4-inch and four 1-1/2-inch interchangeable lenses included  
 Adjustable height up to 6.5 (36", 24", 12" and 6" stems)  
 Includes 4 swiveling heads  
 Switch-selectable CCT  
 Integrated dimmable driver  
 Canopy mount on 4" octagon junction box  
 5-year warranty

**Finish**

● **BK** Black

**Accessories**

**CAPD-ACLLL**  
 Kit of 4 long lenses (1/4-inch)  
**CAPD-ACCLS**  
 Kit of 4 short lenses (1-1/2-inch)

**Note**

Other color temperatures, finishes, and voltage options are available but may require minimum order quantities (MOQs) and longer lead times. Please contact your DALI representative for more information.

NEW

# BOULEVARD

The Boulevard series, a linear modular light fixture perfect for general office, home, and shop illumination. Can be interconnected to produce striking visual effects.

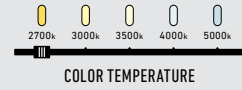

**T24  
JA8**  
CERTIFIED

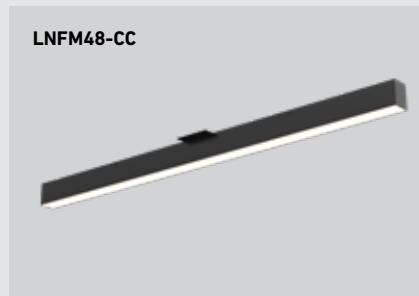
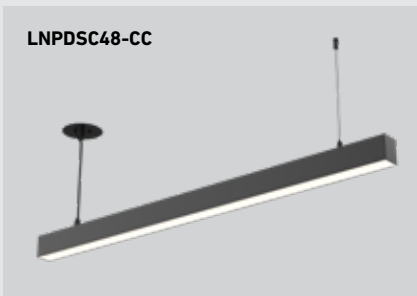
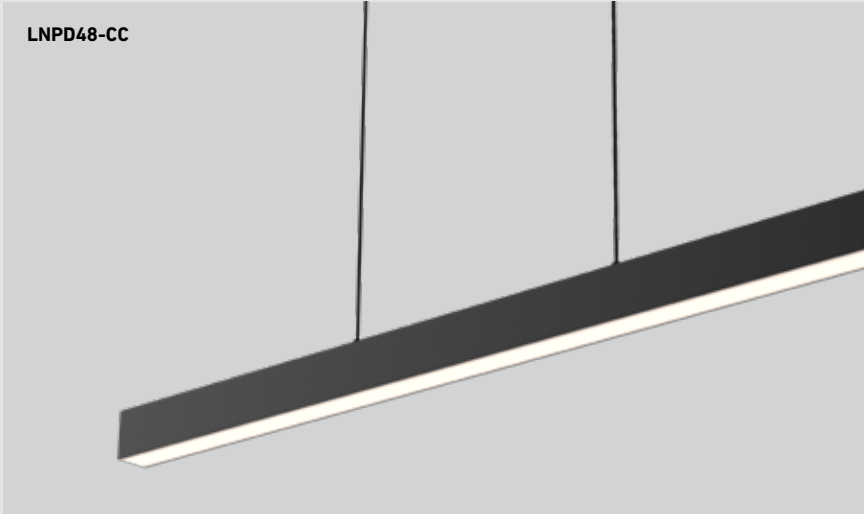

Model	Size	Watts	Delivered lumens	CRI	Color °T	Voltage options ⚡
LNP48-CC	48"	40 W	2805 lm	90	2700, 3000, 3500, 4000, 5000 K	<b>120V TRIAC dimming</b>
LNP48-CC	48"	40 W	2805 lm			or
LNF48-CC	48"	40 W	3000 lm			<b>V: 120 / 277 / 347V 0-10V dimming</b> (Check for availability)

### LNPD48-CC

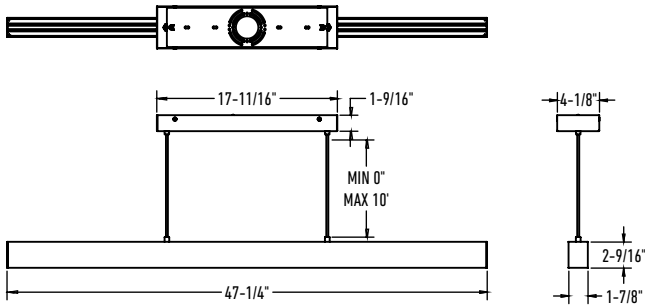

### LNFM48-CC

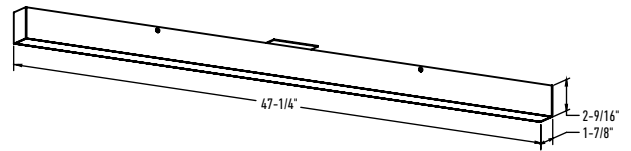

### LNPDSC48-CC

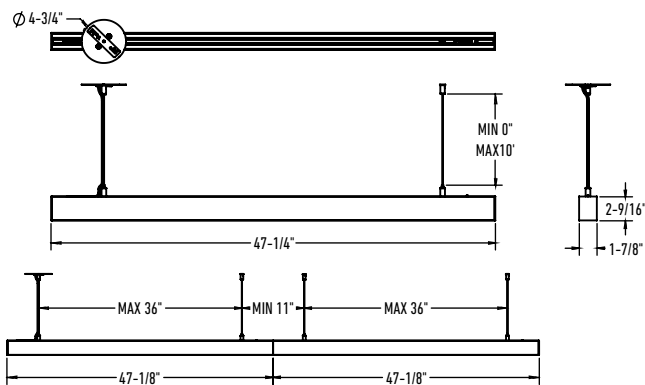

### More from this family



**LNR24-CC**  
pg. 50



**LNR48-CC**  
pg. 50

### Specifications

Switch-selectable CCT  
Unique 20% up/ 80% down light output (LNPD48-CC, LNPDSC48-CC only)  
Multiple fixtures can be linked together  
LNFM48 can be mounted on 4" octagon junction box or directly on the ceiling  
Adjustable height up to 10 feet  
Aluminum housing which serves as a highly efficient heat sink  
Integrated dimmable driver  
Canopy mount on 4" octagonal junction box  
5-year warranty

### Finish

- **BK** Black
- **WH** White

### Accessories

#### LNACC-L16FT

16-foot lens for Boulevard series pendants, flush mounts and recessed linears

### Multi-voltage (V) ⚡

This product family offers multi-voltage drivers (120/277/347) that are dimmable using 0-10V dimming systems. Please note that longer lead times may apply for this option. Kindly reach out to your DALI representative for additional information and to confirm availability.

### Note

Other color temperatures, finishes, and voltage options are available but may require minimum order quantities (MOQs) and longer lead times. Please contact your DALI representative for more information.

# PINPOINT

The MSL series, with its sleek glossy piano-black reflector, combines contemporary design with functionality, making it the ideal choice for any space

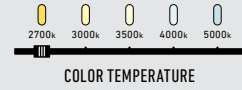

**ADA**  
COMPLIANT\*\*

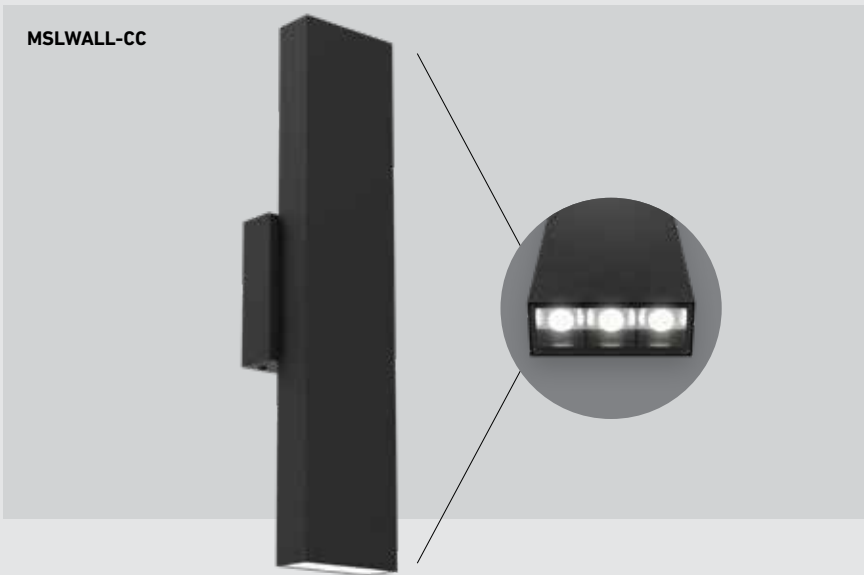
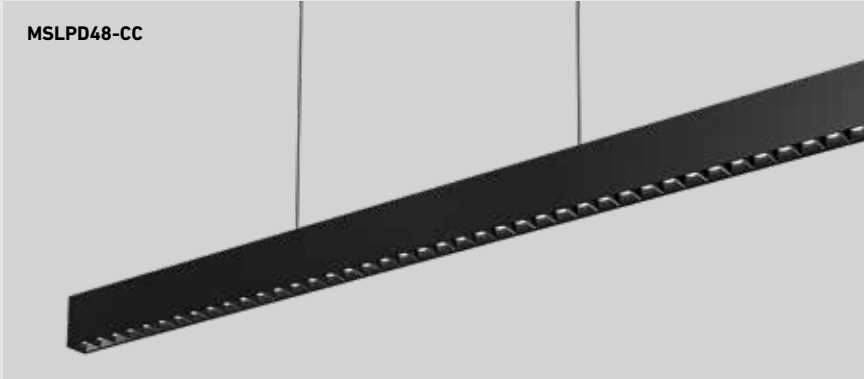

Model	Size	Watts	Delivered lumens	CRI	Color °T	Voltage
MSLPD48-CC*	48"	40 W	2710 lm	90	2700, 3000, 3500,	120 V
MSLWALL-CC**	18"	15 W	760 lm		4000, 5000 K	

**MSLPD48-CC**

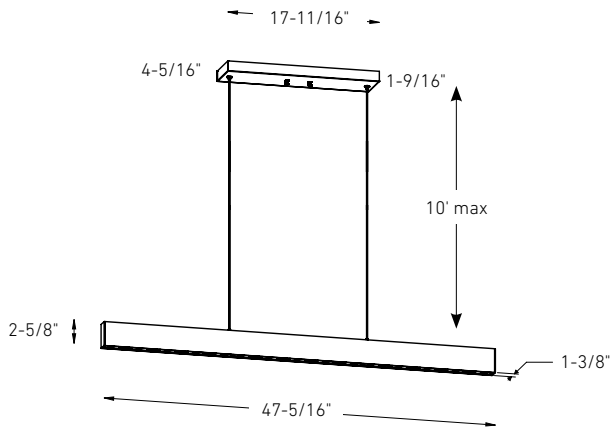

**MSLWALL-CC**

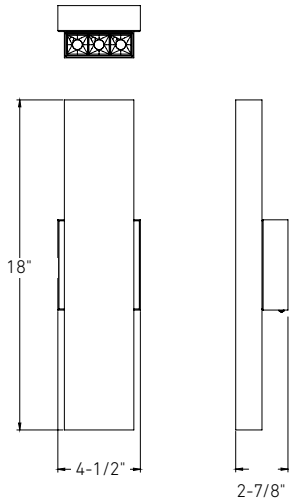

**Specifications**

- Adjustable height up to 10 feet (MSLPD48-CC only)
- Aluminum housing
- Switch-selectable CCT
- 30° beam angle
- Integrated dimmable driver
- Canopy mount on 4" octagon junction box
- 5-year warranty

**Note**

Other color temperatures, finishes, and voltage options are available but may require minimum order quantities (MOQs) and longer lead times. Please contact your DALI representative for more information.

**More from this family**



**MSL1**  
pg. 44



**MSL2**  
pg. 44



**MSL4**  
pg. 44



**MSL5**  
pg. 44



**MSL5G**  
pg. 44



**MSL10**  
pg. 44



**MSL10G**  
pg. 44

**Finish**

- **BK** Black

# BEAM

This sleek design truly utilizes the best features of LED technology. We are now able to create a unique form factor that will project the perfect amount of light.

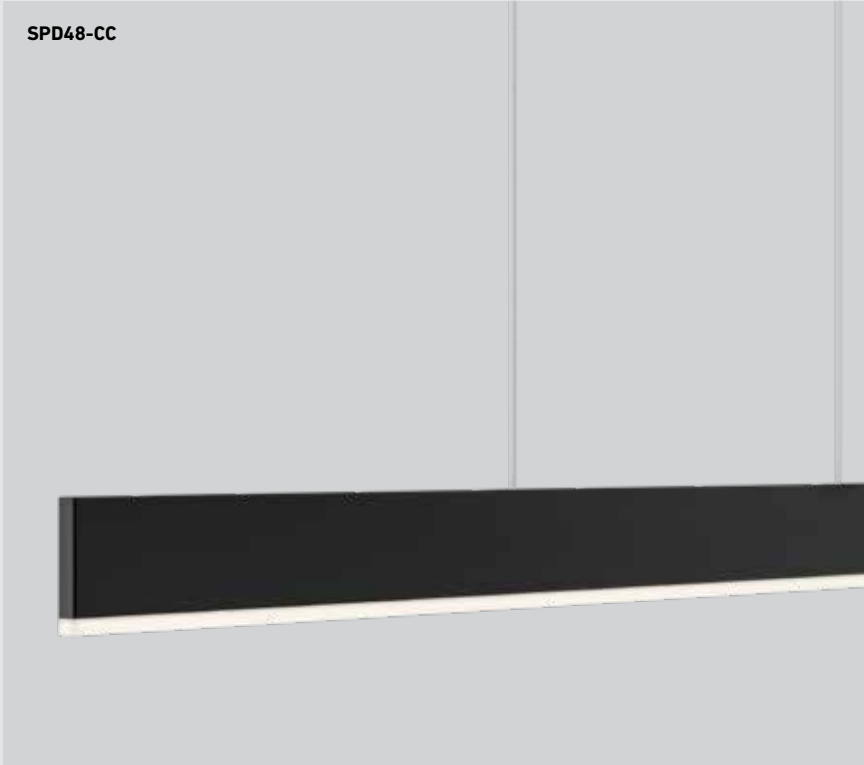
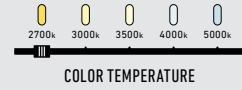

Model	Size	Watts	Delivered lumens	CRI	Color °T	Voltage
SPD48-CC	48"	27 W	1530 lm	90	2700, 3000, 3500, 4000, 5000 K	120 V
SPD72-CC	72"	54 W	2300 lm			

### SPD48-CC

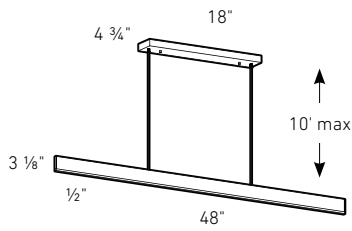

### SPD72-CC

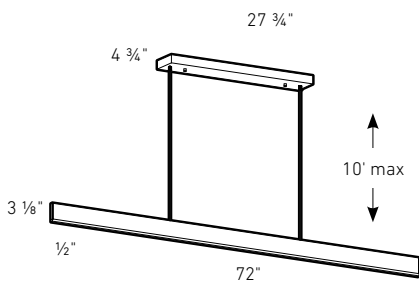

### Specifications

- Adjustable cable length up to 10 feet
- Switch-selectable CCT
- Frosted lens
- Aluminum die-cast housing which serves as a highly efficient heat sink
- Integrated dimmable driver
- 5-year warranty

### Finish

- **BK** Black
- **WH** White

### Note

Other color temperatures, finishes, and voltage options are available but may require minimum order quantities (MOQs) and longer lead times. Please contact your DALs representative for more information.

### More from this family



- SWS24-CC**
  - SWS36-CC**
  - SWS48-CC**
  - SWS60-CC**
- pg. 208







# CURRENT

Elevate your space with this sleek luminary, meticulously crafted to blend seamlessly into contemporary interiors. Its minimalist profile, characterized by a slender silhouette and unobtrusive design, not only illuminates your surroundings with a soft and uniform glow but also serves as a striking aesthetic statement.

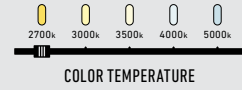

SLPD60-CC

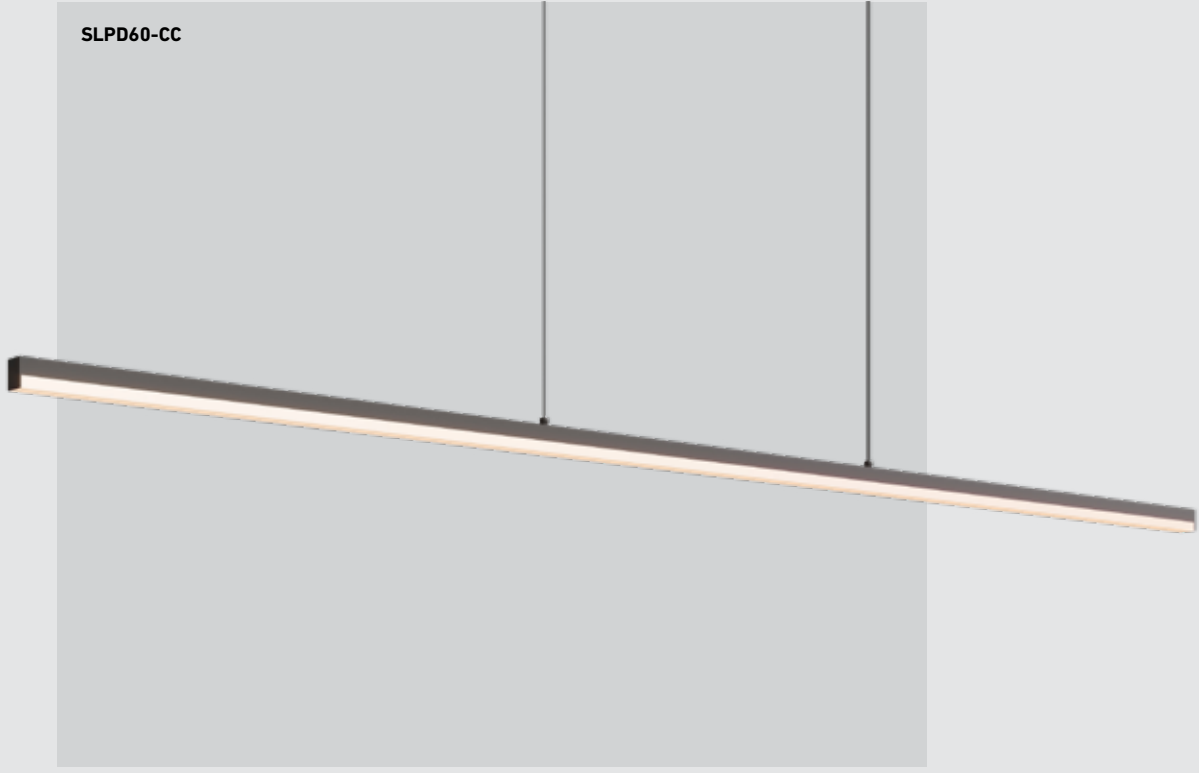

Model	Size	Watts	Delivered lumens	CRI	Color °T	Voltage
SLPD60-CC	60"	32 W	2140 lm	80	2700, 3000, 3500, 4000, 5000 K	120 V



### Specifications

Adjustable height up to 10 feet  
 Switch-selectable CCT  
 Integrated dimmable driver  
 Canopy mount on 4" octagon  
 junction box  
 5-year warranty

### Finish

- **BK** Black
- **GD** Gold
- **WH** White

### Note

Other color temperatures, finishes, and voltage options are available but may require minimum order quantities (MOQs) and longer lead times. Please contact your DALs representative for more information.

### SLPD60-CC

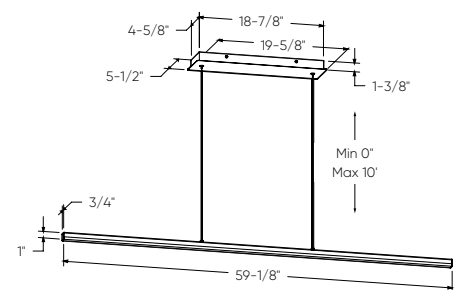

# SWAY

Introducing our cutting-edge, ultra-slim curved linear LED pendant and flush mount lights—  
an embodiment of sophistication and modernity in lighting design

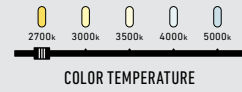

Model	Size	Watts	Delivered lumens	CRI	Color °T	Voltage
<b>W1PD48-CC</b>	48"	24 W	1330 lm	80	2700, 3000, 3500, 4000, 5000 K	120 V
<b>W3PD36-CC</b>	36"	31 W	1590 lm			
<b>W3FM-CC</b>	20"	20 W	880 lm			



**W1PD48-CC**

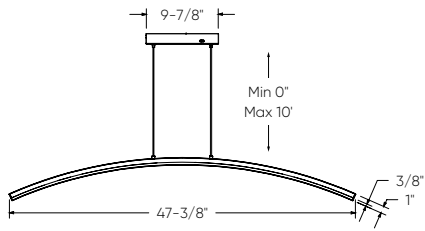

**W3PD36-CC**

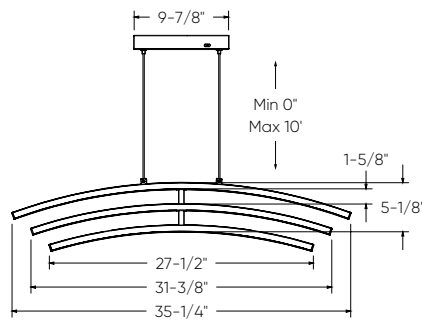

**W3FM-CC**

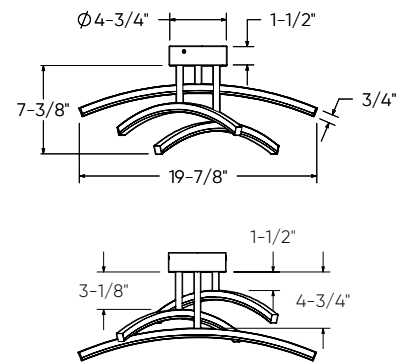

**Specifications**

- Adjustable height up to 10 feet
- Switch-selectable CCT
- Integrated dimmable driver
- Canopy mount on 4" octagon junction box
- 5-year warranty

**Finish**

- **BK** Black
- **GD** Gold

**Note**

Other color temperatures, finishes, and voltage options are available but may require minimum order quantities (MOQs) and longer lead times. Please contact your DALs representative for more information.

# SPIN

Illuminate your space with style, efficiency, and a touch of architectural brilliance with the Spin LED series

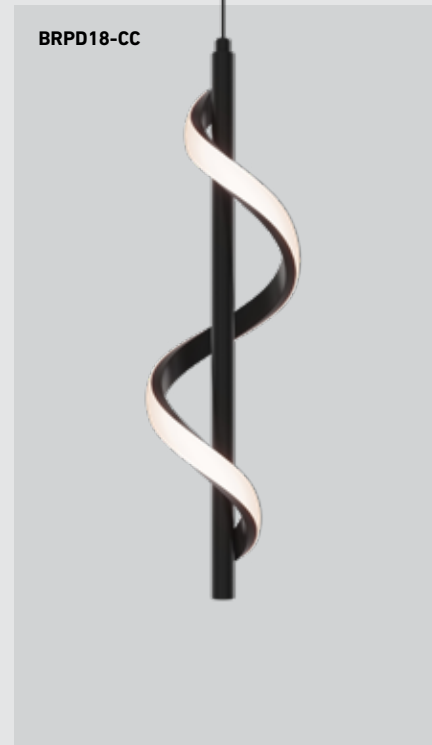
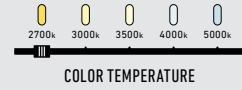

Model	Size	Watts	Delivered lumens	CRI	Color °T	Voltage
<b>BRPD40-CC*</b>	40"	41 W	2410 lm	80	2700, 3000, 3500, 4000, 5000 K	120 V
<b>BRPD18-CC*</b>	18"	15 W	880 lm			
<b>BRV24-CC**</b>	24"	15 W	880 lm			
<b>BRV36-CC**</b>	36"	22 W	1490 lm			

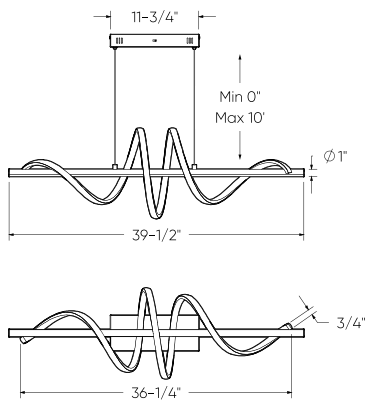
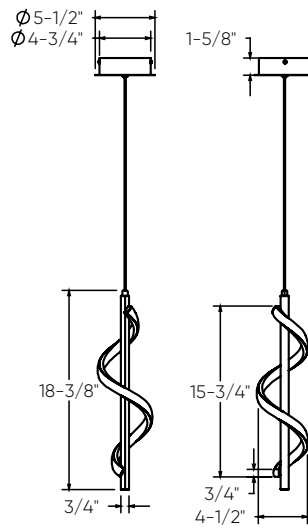
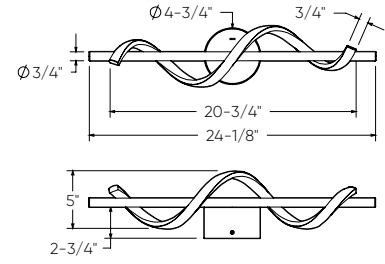
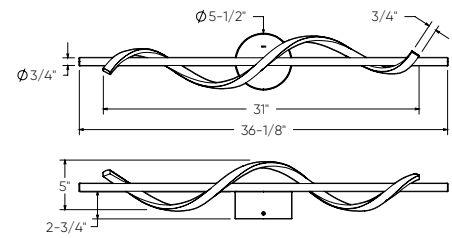
**BRPD40-CC****BRPD18-CC****BRV24-CC****BRV36-CC****Specifications**

Pendant height adjustable up to 10 feet  
 Switch-selectable CCT  
 Integrated dimmable driver  
 Canopy mount on 4" octagon junction box  
 5-year warranty

**Finish**

● **BK** Black

**Note**

Other color temperatures, finishes, and voltage options are available but may require minimum order quantities (MOQs) and longer lead times. Please contact your DALI representative for more information.

# OLYMPIA

A statement lamp with a lot of character. With its 5 adjustable rings, this linear pendant emits a bright light that makes it perfect for use as a primary light source over a kitchen counter, dining table, or even in a bar setting.

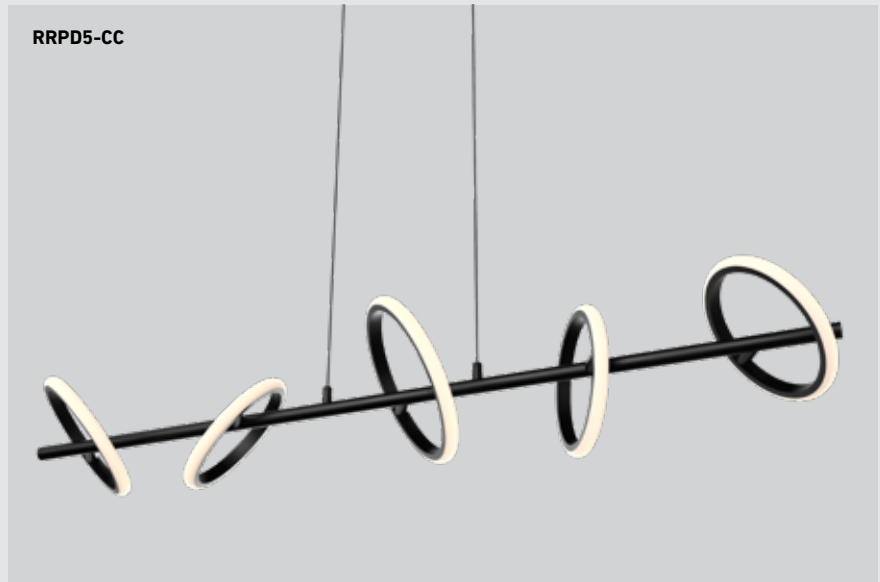
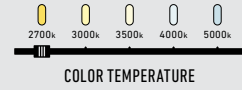

Model	Size	Watts	Delivered lumens	CRI	Color °T	Voltage
RRPD2-CC	14"	12 W	750 lm	80	2700, 3000, 3500,	120 V
RRPD5-CC	42"	30 W	1530 lm		4000, 5000 K	



### RRPD2-CC

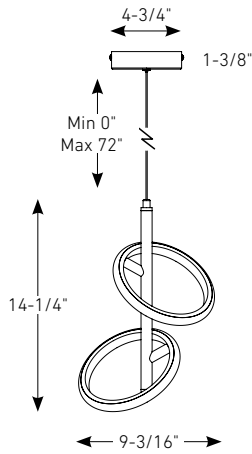

### RRPD5-CC

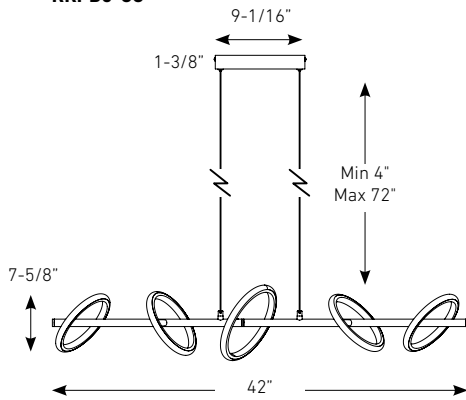

### Specifications

Adjustable height up to 6 feet  
Switch-selectable CCT  
Integrated dimmable driver  
Canopy mount on 4" octagon  
junction box  
5-year warranty

### Finish

● **BK** Black

### Note

Other color temperatures, finishes, and voltage options are available but may require minimum order quantities (MOQs) and longer lead times. Please contact your DALI representative for more information.

# HELIX

A classic shape with a contemporary design. Helix is perfect for adding stature and prestige to any space. Its gentle spirals instantly enhance areas of the bedroom, kitchen islands, offices, and reading nooks.

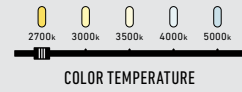

Model	Size	Watts	Delivered lumens	CRI	Color °T	Voltage
SPR20-CC	20"	30 W	1060 lm	80	2700, 3000, 3500,	120 V
SPR34-CC	34"	60 W	2370 lm		4000, 5000 K	

### SPR20-CC

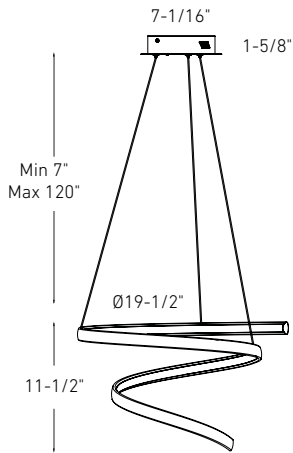

### SPR34-CC

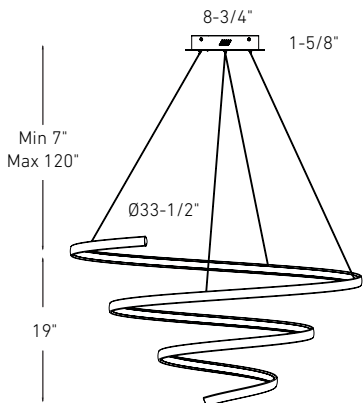

### Specifications

Adjustable height up to 10 feet  
Switch-selectable CCT  
Frosted lens  
Integrated dimmable driver  
Canopy mount on 4" octagonal junction box  
5-year warranty

### Finish

● **BK** Black

### Note

Other color temperatures, finishes, and voltage options are available but may require minimum order quantities (MOQs) and longer lead times. Please contact your DALI representative for more information.

# TWIST

This smaller ribbon-like pendant gives you a continuous warm flow. As a new addition to our popular pendant series, it's ideal for smaller foyers, over a console table or even above the sink.

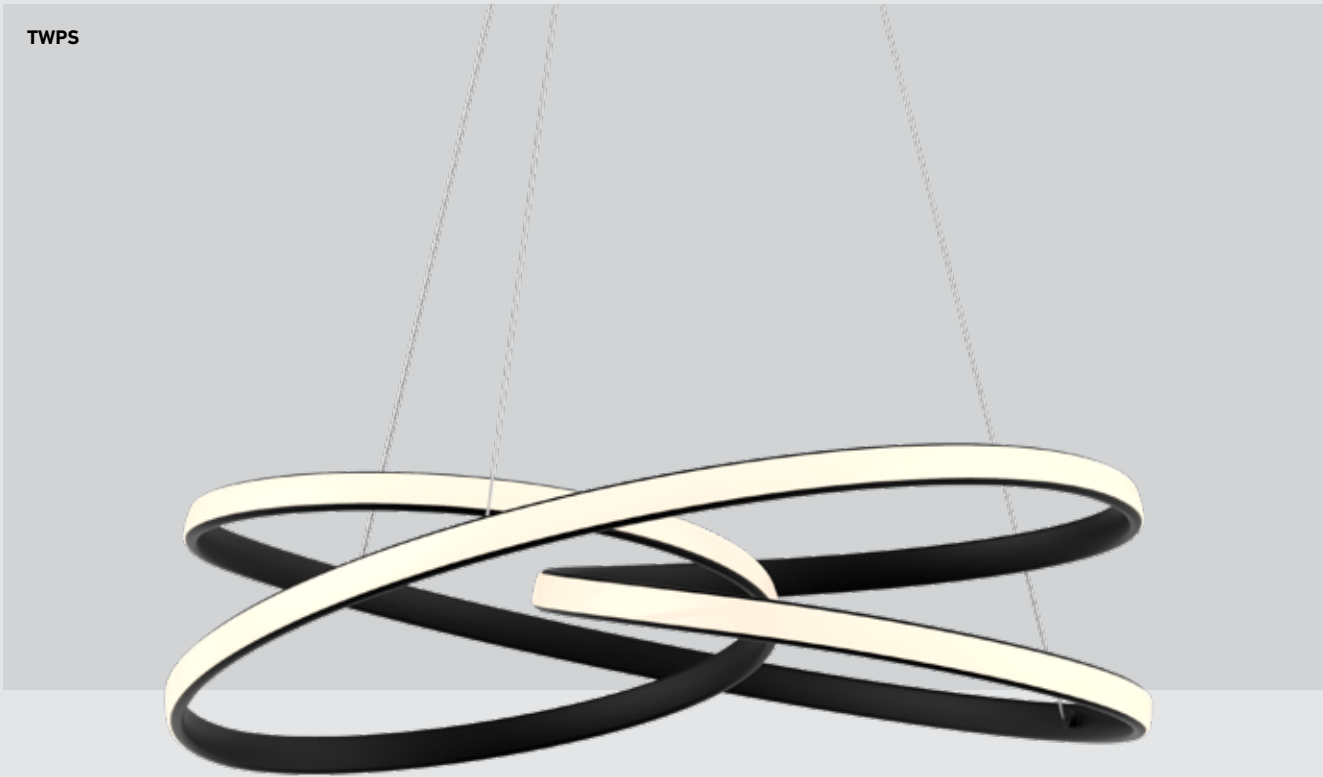
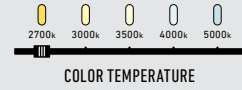

Model	Size	Watts	Delivered lumens	CRI	Color °T	Voltage
TWPS	20.5"	30 W	1800 lm	85	3000 K	120 V

---

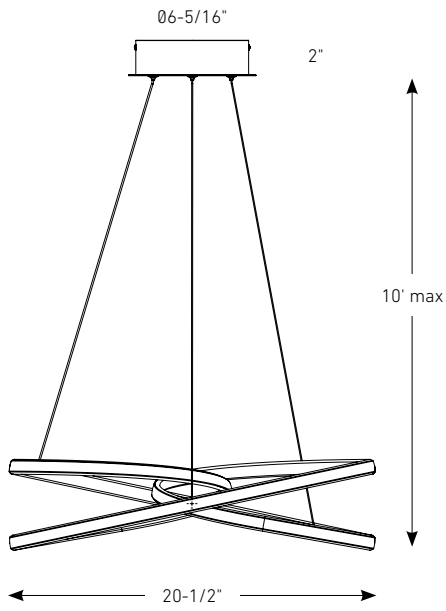
**TWPS**

---

**Specifications**

Adjustable height up to 10 feet  
Frosted lens  
Integrated dimmable driver  
Canopy mount on 4" octagon junction box  
5-year warranty

---

**Finish**

● **BK** Black

---

**Note**

Other color temperatures, finishes, and voltage options are available but may require minimum order quantities (MOQs) and longer lead times. Please contact your DALSi representative for more information.

# TWIRL

This ribbon-like pendant gives you a continuous warm white flow. It will definitely be a beautiful focal point to any room.

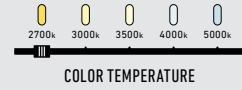

TWPD-CC



Model	Size	Watts	Delivered lumens	CRI	Color °T	Voltage
TWPD-CC	28"	84 W	3960 lm	80	2700, 3000, 3500, 4000, 5000 K	120 V

**TWPD-CC**

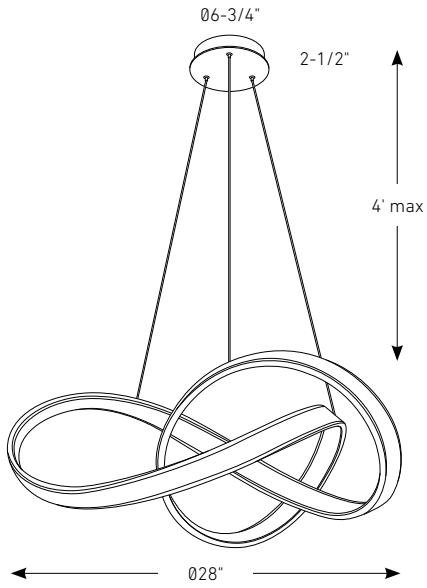

**Specifications**

- Adjustable height up to 4 feet
- Frosted lens
- Integrated dimmable driver
- Canopy mount on 4" octagon junction box
- 5-year warranty

**Finish**

- **BK** Black

**Note**

Other color temperatures, finishes, and voltage options are available but may require minimum order quantities (MOQs) and longer lead times. Please contact your DALs representative for more information.

# ATOM

A unique design with clean lines that will add the final touch to your office, bedroom and even that newly renovated mud room. The double-sided ring will add warmth and character.

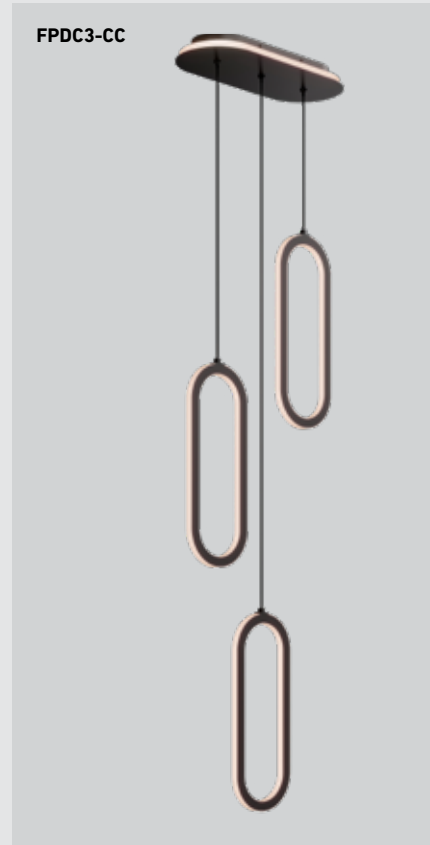
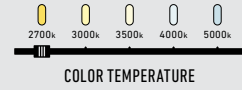

Model	Size	Watts	Delivered lumens	CRI	Color °T	Voltage
FPD60-CC	60"	50 W	1700 lm	90	2700, 3000, 3500, 4000, 5000 K	120 V
FPD-CC	16"	24 W	820 lm			
FPDC3-CC	16-3/8"/3 lights	40 W	1400 lm			
FDB-CC	16"	40 W	1350 lm			

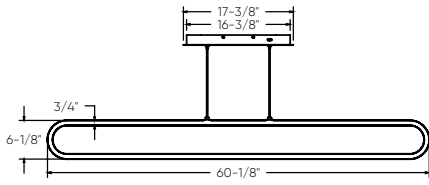
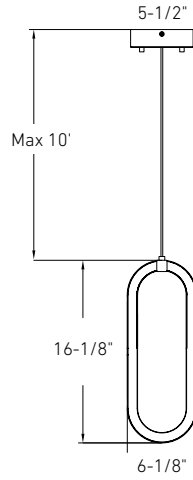
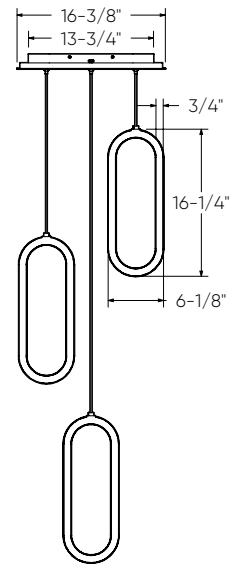
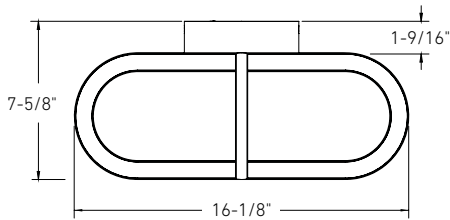

**FPD60-CC****FPD-CC****FPDC3-CC****FDB-CC****Specifications**

Pendant height adjustable up to 10 feet  
 Switch-selectable CCT  
 Integrated dimmable driver  
 Canopy mount on 4" octagon junction box  
 5-year warranty

**Finish**

- **BK** Black
- **GD** Gold  
(Not available for FPD60-CC)

**Note**

Other color temperatures, finishes, and voltage options are available but may require minimum order quantities (MOQs) and longer lead times. Please contact your DALI representative for more information.

# CIRCA

Illuminate your space in style with our 24-inch circular pendant, available in multiple finishes, featuring adjustable 5 CCT settings for customizable illumination that seamlessly blends style and functionality.

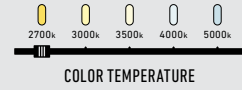

Model	Size	Watts	Delivered lumens	CRI	Color °T	Voltage
RGPD24-CC	24"	28 W	1500 lm	80	2700, 3000, 3500, 4000, 5000 K	120 V



**RGPD24-CC**

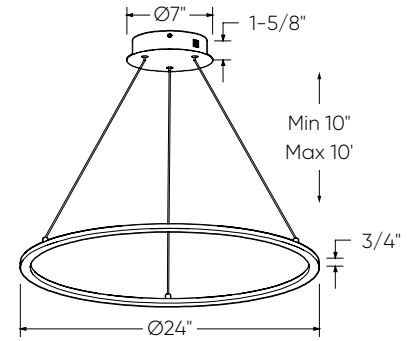

**Specifications**

Adjustable height up to 10 feet  
 Switch-selectable CCT  
 Integrated dimmable driver  
 Canopy mount on 4" octagon  
 junction box  
 5-year warranty

**Finish**

- **BK** Black
- **GD** Gold
- **WH** White

**Note**

Other color temperatures, finishes, and voltage options are available but may require minimum order quantities (MOQs) and longer lead times. Please contact your DALI representative for more information.

# ECLIPSE

Simplicity and elegance are reunited in this minimalist double ring pendant. Over the kitchen island, as foyer lighting or in the boardroom, this will scream sophistication.

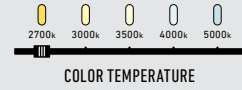

Model	Size	Watts	Delivered lumens	CRI	Color °T	Voltage
PDR14-CC	14"	25 W	1700 lm	80	2700, 3000, 3500, 4000, 5000 K	120 V

**PDR14-CC**

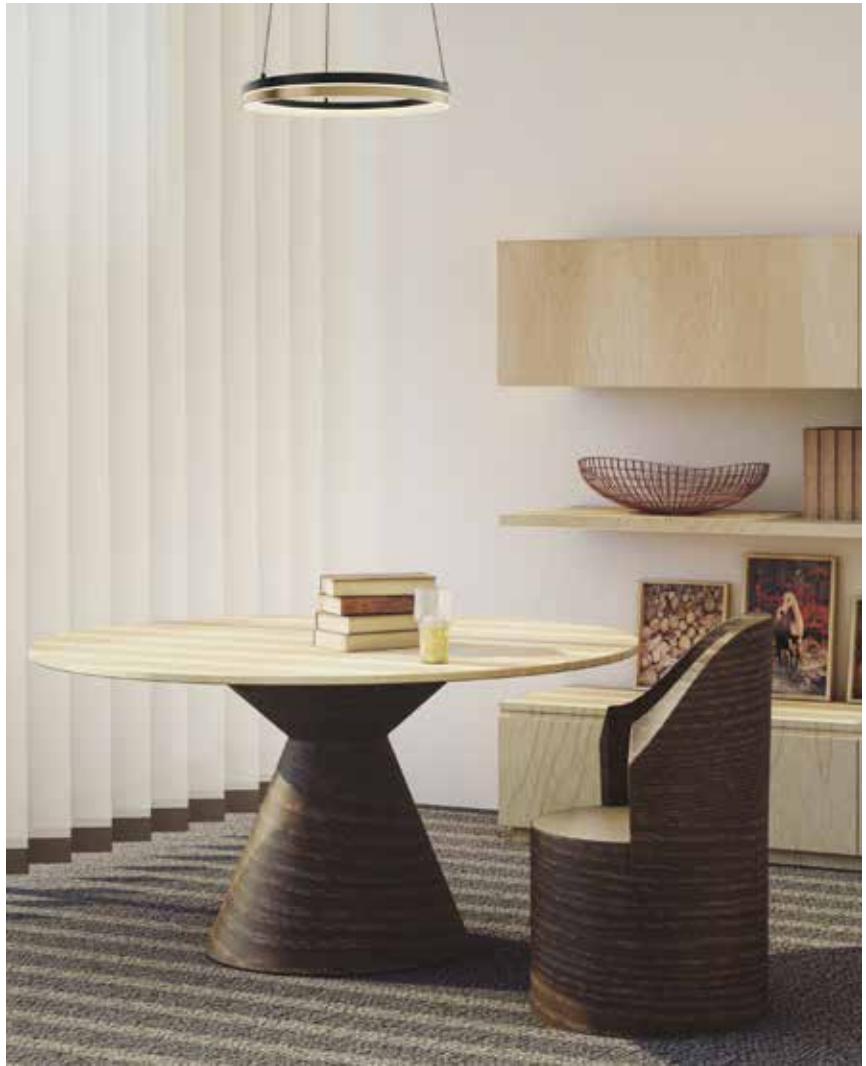
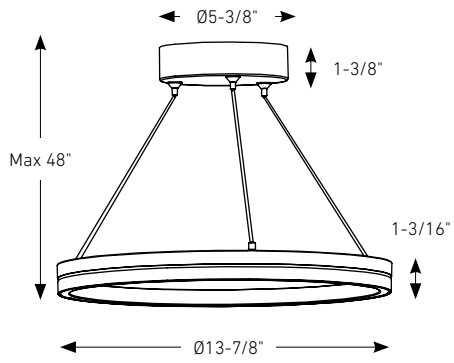

**Specifications**

- Adjustable height up to 4 feet
- Aluminum housing which serves as a highly efficient heat sink
- Switch-selectable CCT
- Frosted lens
- Integrated dimmable driver
- Canopy mount on 4" octagonal junction box
- 5-year warranty

**Finish**

-  **BG** Black/Gold

**Note**

Other color temperatures, finishes, and voltage options are available but may require minimum order quantities (MOQs) and longer lead times. Please contact your DALI representative for more information.

# PYRA

Discover contemporary elegance with these 22-inch and 34-inch rounded triangular pendant and flush mount lights, available in a variety of finishes and customizable 5CCT options.

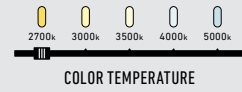

**T24  
JA8**  
CERTIFIED



Model	Size	Watts	Delivered lumens	CRI	Color °T	Voltage
TRFM22-CC	22"	40 W	1900 lm	90	2700, 3000, 3500,	120 V
TRPD34-CC	34"	80 W	3600 lm		4000, 5000 K	

### TRPD34-CC

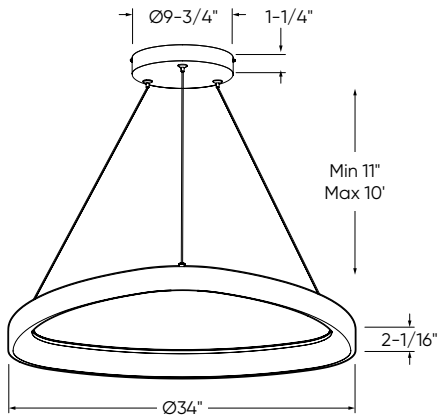

### TRFM22-CC

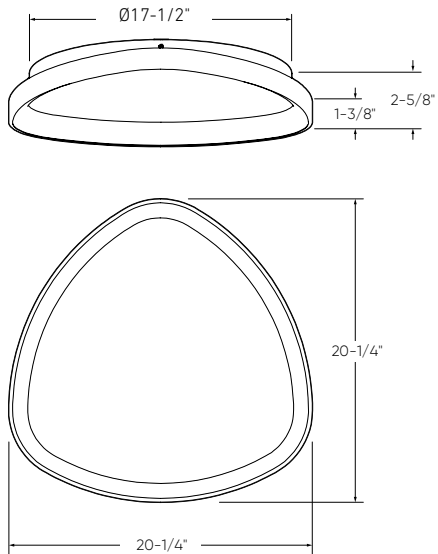

### Specifications

Pendant height adjustable up to 10 feet  
Switch-selectable CCT  
Integrated dimmable driver  
Canopy mount on 4" octagon junction box  
5-year warranty

### Finish

- **BK** Black
- **GD** Gold
- **WH** White

### Note

Other color temperatures, finishes, and voltage options are available but may require minimum order quantities (MOQs) and longer lead times. Please contact your DALs representative for more information.

# DROP

Illuminate your space in style with our two-tier 20-inch pendant, showcasing two-zone lighting with a lit canopy and a 12-inch downlight—all customizable with 5 CCT options—in a sleek black finish, effortlessly blending modern design with versatile functionality.

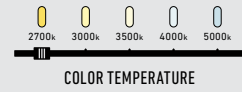

CFPD20-CC



Model	Size	Watts	Delivered lumens	CRI	Color °T	Voltage
CFPD20-CC	20"	39 W	1675 lm	80	2700, 3000, 3500, 4000, 5000 K	120 V



**CFPD20-CC**

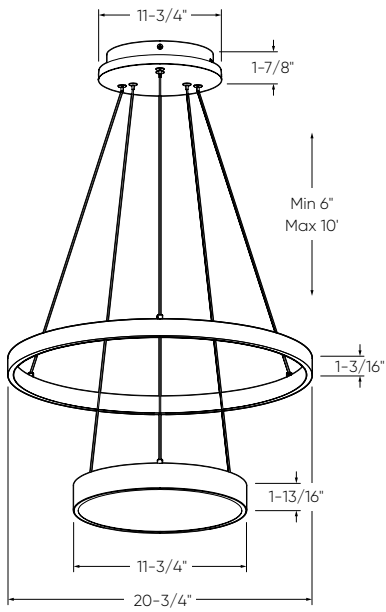

**Specifications**

- Adjustable height up to 10 feet
- Both lights are independently adjustable
- Switch-selectable CCT
- Integrated dimmable driver
- Illuminated canopy
- Canopy mount on 4" octagon junction box
- 5-year warranty

**Finish**

- **BK** Black

**Note**

Other color temperatures, finishes, and voltage options are available but may require minimum order quantities (MOQs) and longer lead times. Please contact your DALI representative for more information.





# ASTERISK

Apportez une touche de sophistication à votre espace avec la famille Asterisk, alliant style et fonctionnalité pour éclairer votre environnement avec élégance moderne.

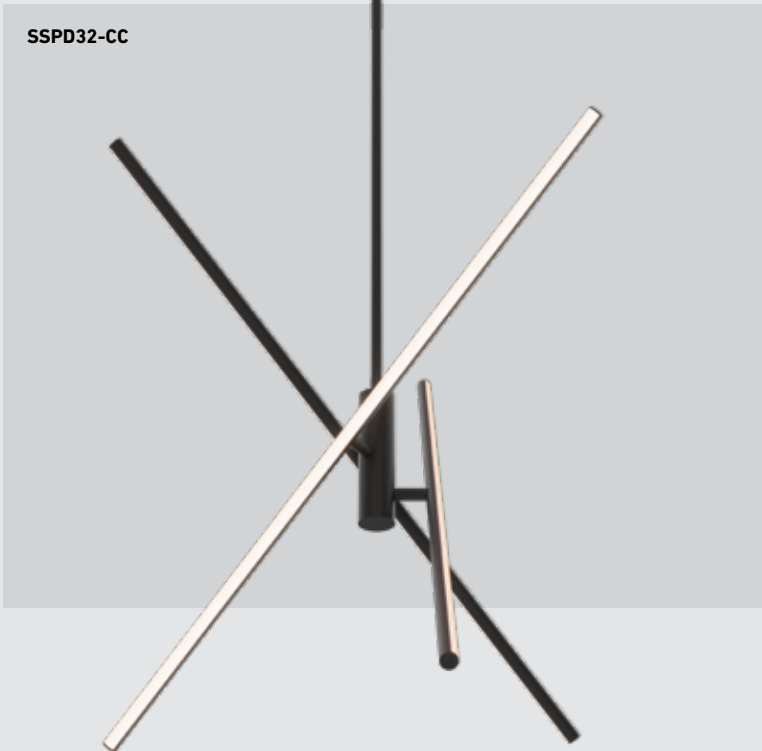
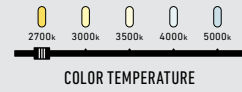

Model	Size	Watts	Delivered lumens	CRI	Color °T	Voltage
SSPD32-CC	32"	30 W	1500 lm	80	2700, 3000, 3500,	120 V
SSFM20-CC	20"	15 W	1060 lm		4000, 5000 K	



**SSPD32-CC**

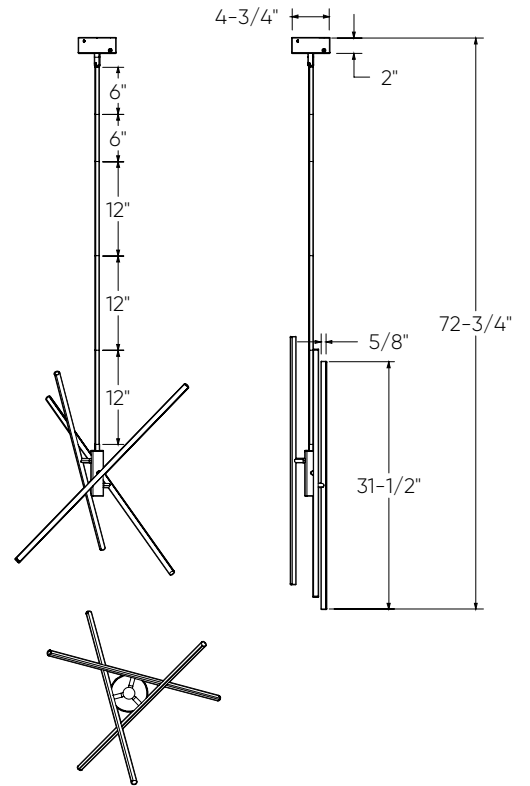

**SSF20-CC**

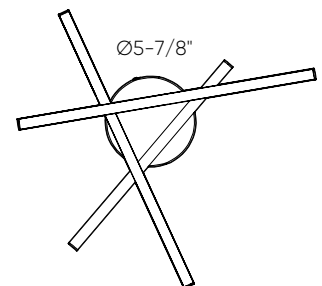
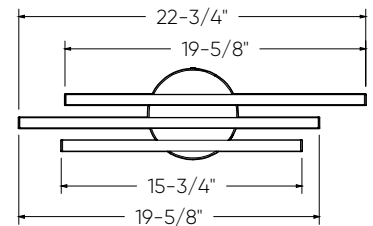
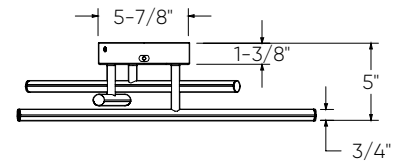

**Specifications**

- Adjustable height up to 10 feet
- Switch-selectable CCT
- Integrated dimmable driver
- Includes 5 robust stems
- Canopy mount on 4" octagon junction box
- 5-year warranty

**Finish**

- **BK** Black

**Note**

Other color temperatures, finishes, and voltage options are available but may require minimum order quantities (MOQs) and longer lead times. Please contact your DALIS representative for more information.

# STELLAR

The Stellar series is designed to illuminate your space like no other. With both uplight and downlight elements, these fixtures make a striking addition to any dining room, kitchen, living room, or foyer

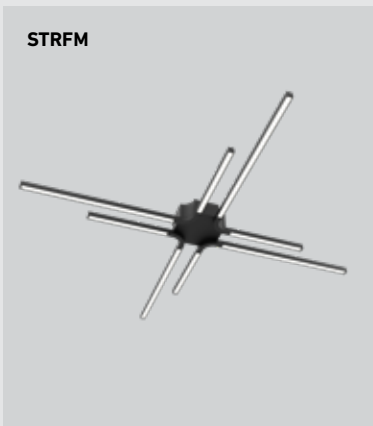
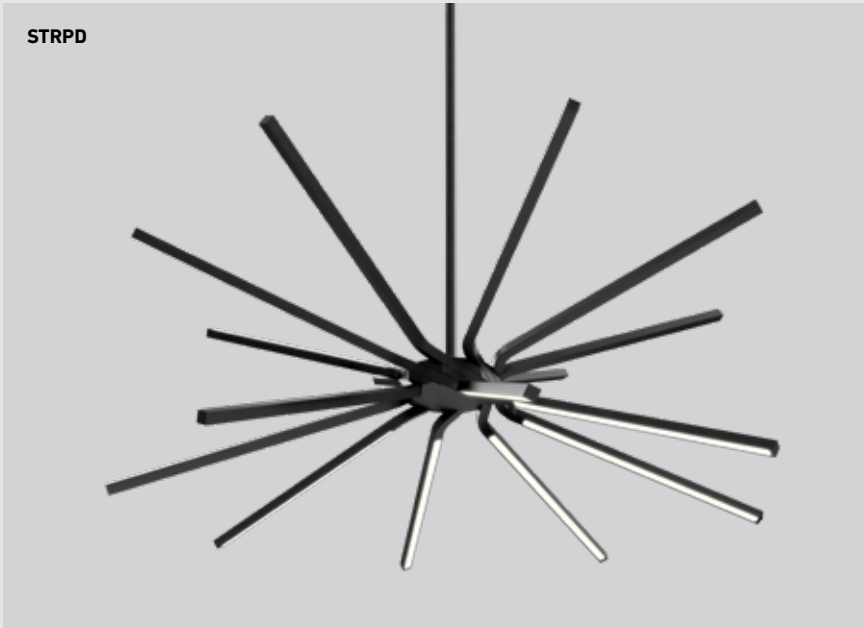

3000k

COLOR TEMPERATURE



**ADA**  
COMPLIANT\*\*

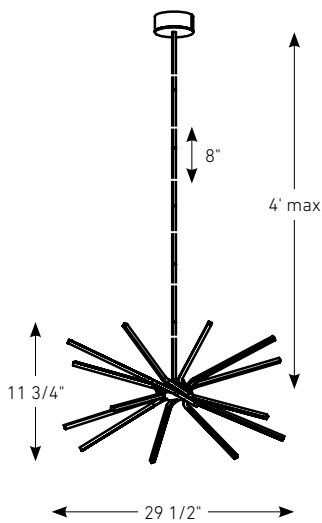
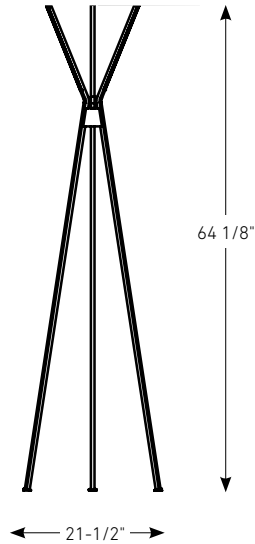
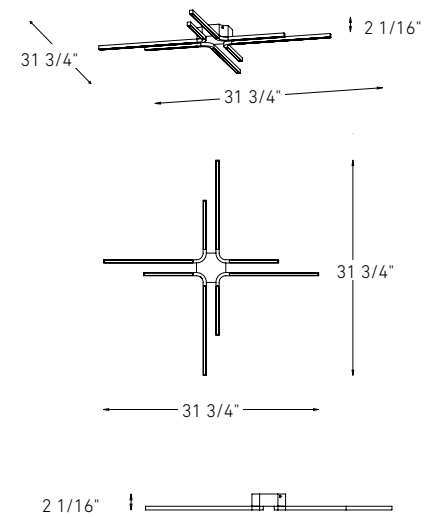
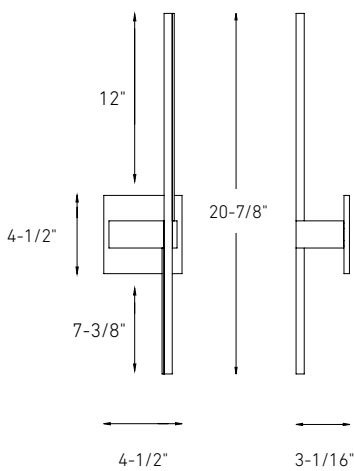
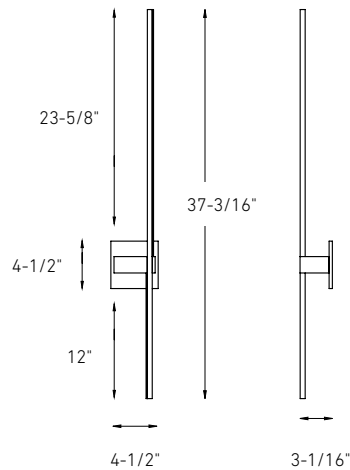

Model	Size	Watts	Delivered lumens	CRI	Color °T	Voltage
STRPD*	30"	33 W	1880 lm	90	3000 K	120 V
STRFL*	64"	14 W	1200 lm			
STRFM*	32"	40 W	2000 lm			
STK21**	21"	7 W	400 lm			
STK37**	37"	13 W	840 lm			

**STRPD****STRFL****STRFM****STK21****STK37****Specifications**

Aluminum housing which serves as a highly efficient heat sink  
 Frosted lens  
 Integrated dimmable driver  
 Canopy mount on 4" octagon junction box  
 5-year warranty

**Finish**

- **BK** Black
- **WH** White

**Note**

Other color temperatures, finishes, and voltage options are available but may require minimum order quantities (MOQs) and longer lead times. Please contact your DALI representative for more information.









# NOVA

Designed for modern and new builds, this cylindrical hanging pendant provides a simple and elegant way to enhance your space. At 18-inches in length, and with an ultra-thin flat canopy with adjustable 10-foot cable, this fixture can be installed as easily as any recessed light. Switch-selectable color temperatures ranging from 3000, 3500, and 4000 K, to create a subtle and customizable lighting effect.

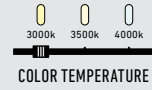

Model	Size	Watts	Delivered lumens	CRI	Color °T	Voltage
PDC18-CC	18"	9 W	510 lm	90	3000 K - 3500 K - 4000 K	120 V



**PDC18-CC**

Ø3 3/8"

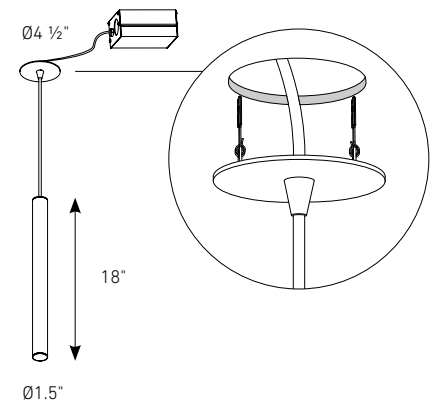

### Specifications

Adjustable cable length up to 10 feet  
 Switch-selectable CCT  
 Every fixture includes a junction box with integrated dimmable driver  
 Ultra-slim canopy, installs like a recessed fixture  
 Frosted reflector  
 5-year warranty

### Finish

- **BK** Black
- **SBA** Sandblasted aluminum
- **WH** White

### Accessories

**RFP-UNI**  
 Universal rough-in plate

### Note

Other color temperatures, finishes, and voltage options are available but may require minimum order quantities (MOQs) and longer lead times. Please contact your DALs representative for more information.

# CHANNEL

These beautiful modern pendants with vertical light strips running along the side create tasteful accents to any interior design, whether in a cluster or standalone. Height adjustable 10-foot cables and flexible switch-selectable color temperatures make these decorative pendants an easy choice. Available in multiple sizes and finishes.

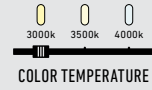

Model	Size	Watts	Delivered lumens	CRI	Color °T	Voltage
PDLED120-24	24"	30 W	300 lm	90	3000, 3500, 4000 K	120 V - 277 V
PDLED120-36	36"	30 W	300 lm			
PDLED120-48	48"	30 W	300 lm			
PDLED120-60	60"	30 W	300 lm			
PDLED120-5	Ø22"/5 lights	150 W	1500 lm			
PDLED120-8	Ø26"/8 lights	240 W	2400 lm			
PDLED120-5SQ	47"/5 lights	150 W	1500 lm			
PDLED120-8SQ	84"/8 lights	240 W	2400 lm			

**PDLED120-24**

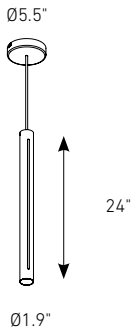

**PDLED120-36**

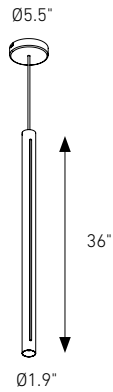

**PDLED120-48**

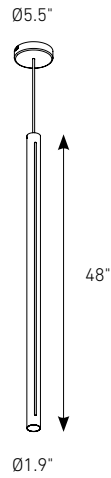

**PDLED120-60**

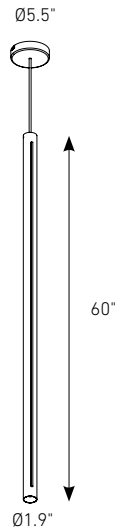

**PDLED120-5**

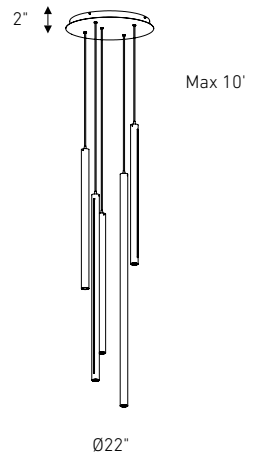

**PDLED120-8**

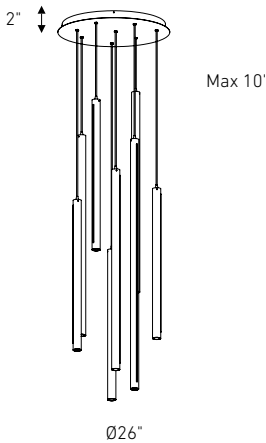

**PDLED120-5SQ**

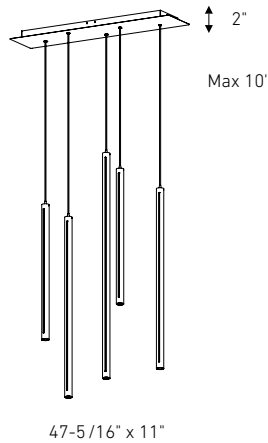

**PDLED120-8SQ**

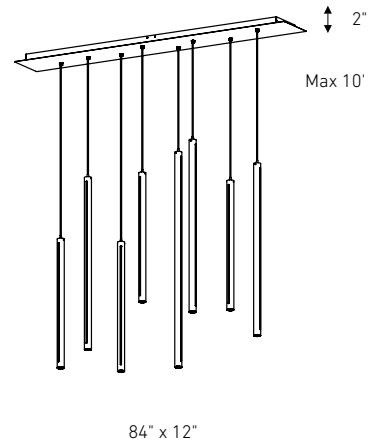

**Specifications**

Adjustable cable length to 10 feet  
 Switch-selectable CCT: 3000 K/  
 3500 K/4000 K inside canopy  
 Frosted reflector  
 Canopy mount on 4" octagon junction box  
 Integrated dimmable driver  
 Compatible with TRIAC, ELV and  
 0-10 V dimmers  
 5-year warranty

**Finish**

- **BK** Black
- **WH** White

**Note**

Other color temperatures, finishes, and voltage options are available but may require minimum order quantities (MOQs) and longer lead times. Please contact your DALI representative for more information.

NEW

# FOCUS

The Focus modern LED cylinder flush mounts are available in two sizes—5-inch and 6-inch—with the larger size featuring a multi-voltage driver for added versatility.

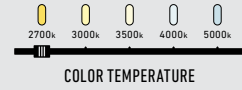

T24  
JA8  
CERTIFIED

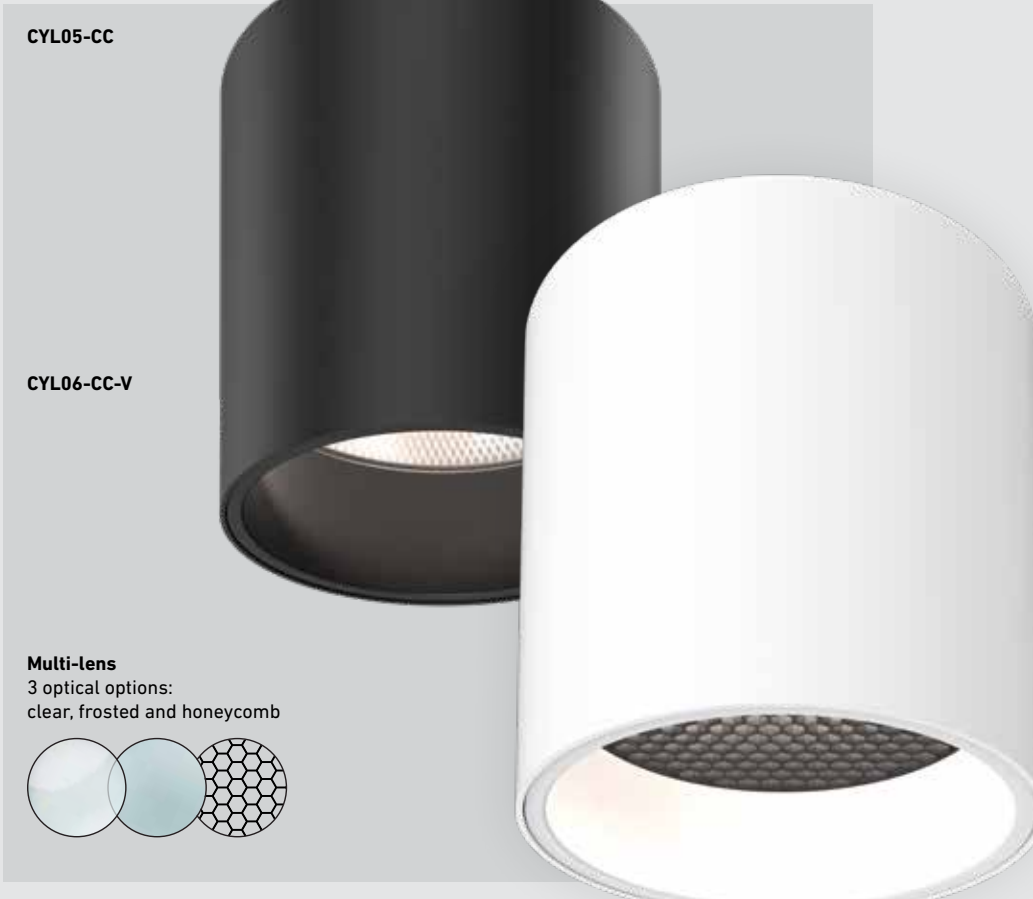

CYL05-CC

CYL06-CC-V

**Multi-lens**  
3 optical options:  
clear, frosted and honeycomb

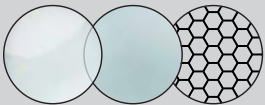

Model	Size	Watts	Delivered lumens	CRI	Color °T	Voltage
CYL05-CC	5"	20 W	1000 lm	90	2700, 3000, 3500, 4000, 5000 K	120 V
CYL06-CC-V	6"	26 W	1500 lm	90	2700, 3000, 3500, 4000, 5000 K	V: 120 / 277 / 347V 0-10V dimming



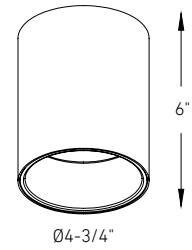

---

#### CYL05-CC

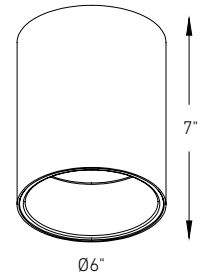

---

#### CYL06-CC-V



---

#### Specifications

Every fixture includes a junction box with an integrated driver  
 3 optical options: clear, frosted and honeycomb  
 35° beam angle for CYL05-CC  
 45° beam angle for CYL06-CC-V  
 Aluminum construction  
 Switch-selectable CCT  
 5-year warranty

---

#### Finish

- **BK** Black
- **WH** White

#### Accessories

**CYL05-TRIM-XX**  
 Internal trim for 5" cylinder available in Alzak, Black, Gold, or White finishes

**CYL06-TRIM-XX**  
 Internal trim for 6" cylinder available in Alzak, Black, Gold, or White finishes

---

#### Note

Other color temperatures, finishes, and voltage options are available but may require minimum order quantities (MOQs) and longer lead times. Please contact your DALI representative for more information.

# HOVER

Rise to the occasion – crafted to ascend in design, this versatile fixture adds a contemporary touch to any room, bringing a sleek and efficient aesthetic to your space.

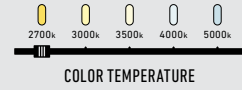

CCFM-CC



Model	Size	Watts	Delivered lumens	CRI	Color °T	Voltage
CCFM-CC	24"	42 W	2250 lm	80	2700, 3000, 3500, 4000, 5000 K	120 V



**CCFM-CC**

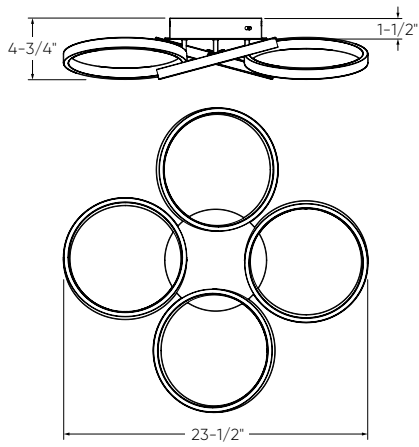

**Specifications**

- Switch-selectable CCT
- Integrated dimmable driver
- Canopy mount on 4" octagon junction box
- 5-year warranty

**Finish**

- BK** Black
- GD** Gold

**Note**

Other color temperatures, finishes, and voltage options are available but may require minimum order quantities (MOQs) and longer lead times. Please contact your DALI representative for more information.

# NEWTON

A classic yet modern style, this unique flush mount will definitely impress. Not only will it light up the room from its central light source but will also emit a soft glow from its illuminated outer rings.

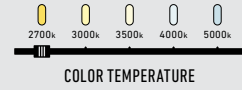

FMT18-CC



Model	Size	Watts	Delivered lumens	CRI	Color °T	Voltage
FMT18-CC	18"	24 W	1300 lm	80	2700, 3000, 3500, 4000, 5000 K	120 V

**FMT18-CC**

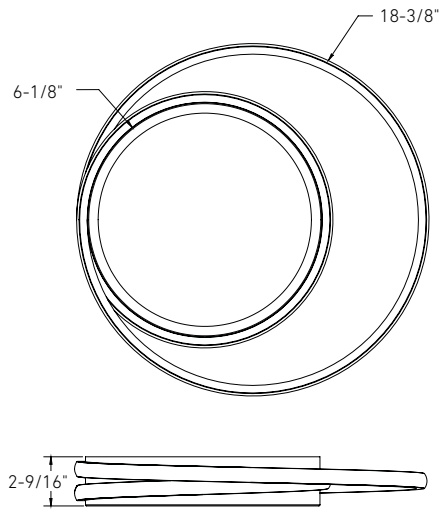

**Specifications**

Die-cast aluminum housing  
Switch-selectable CCT  
Canopy mount on 4" octagonal junction box  
Adjustable mounting position  
5-year warranty

**Finish**

● **BK** Black

**Note**

Other color temperatures, finishes, and voltage options are available but may require minimum order quantities (MOQs) and longer lead times. Please contact your DALs representative for more information.

# MISTY

This flush mount offers clean lines and a wonderful semi-opaque diffuser that adds flair without being the center of attention. It will definitely blend into any project you may have.

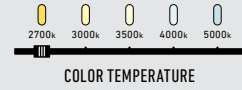

FUZ11-CC



Model	Size	Watts	Delivered lumens	CRI	Color °T	Voltage
FUZ11-CC	11"	15 W	1000 lm	80	2700, 3000, 3500, 4000, 5000 K	120 V

**FUZ11-CC**

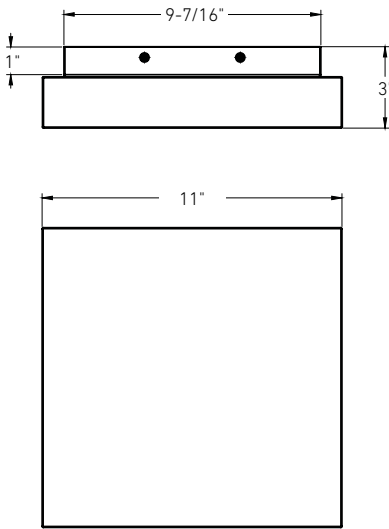

**Specifications**

Integrated dimmable driver  
Die-cast aluminum housing  
Switch-selectable CCT  
Canopy mount on 4" octagonal junction box  
5-year warranty

**Finish**

● **BK** Black

**Note**

Other color temperatures, finishes, and voltage options are available but may require minimum order quantities (MOQs) and longer lead times. Please contact your DALs representative for more information.

# AURORA

We have succeeded in creating a very unique solution with our LED flush mounts. They project a tremendous amount of light, and can also be dimmed to provide a back-lit halo that will gently illuminate your way during the night hours.

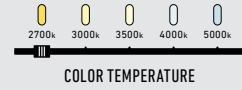

CFH12-CC



Model	Size	Watts	Delivered lumens	CRI	Color °T	Voltage
CFH12-CC	12"	27 W	1725 lm	90	2700, 3000, 3500, 4000, 5000 K	120 V



CFH12-CC

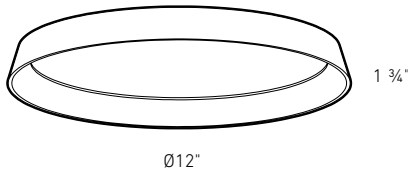

**Specifications**

- Dual control functionality: Adjust the CCT of the main light and backlight independently
- Frosted lens
- Edge-lit technology
- Die-cast aluminum housing
- General lighting zone turns off in the lower dimming range, back lighting stays on
- Canopy mount on 4" octagon junction box
- 5-year warranty

**Finish**

- **BK** Black
- **WH** White

**Note**

Other color temperatures, finishes, and voltage options are available but may require minimum order quantities (MOQs) and longer lead times. Please contact your DALs representative for more information.

# ORA

A beautiful round glass flush mount that offers more than the eye can see. With five color temperatures to choose from, this is as versatile as can be. From hallways to bedrooms and bathrooms to basements. It will add flair to any room.

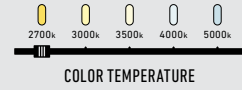

CFG13-CC



Model	Size	Watts	Delivered lumens	CRI	Color °T	Voltage
CFG13-CC	13"	32 W	1800 lm	90	2700, 3000, 3500, 4000, 5000 K	120 V



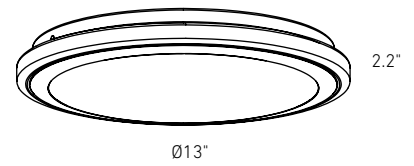

---

**CFG13-CC**

---

**Specifications**

Integrated dimmable driver  
Frosted glass lens  
Die-cast aluminum housing  
Switch-selectable CCT  
Canopy mount on 4" octagonal junction box  
5-year warranty

---

**Finish**

- **BK** Black
- **GD** Gold
- **SN** Satin Nickel

---

**Note**

Other color temperatures, finishes, and voltage options are available but may require minimum order quantities (MOQs) and longer lead times. Please contact your DALSS representative for more information.

# FUSION FLUSH MOUNT

The Fusion trimless 12- and 21-inch flush mount family showcase a harmonious union of minimalist design and expansive illumination, providing a blend of sophistication and functionality for contemporary spaces.

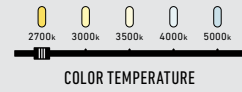

TLFM12-CC



Model	Size	Watts	Delivered lumens	CRI	Color °T	Voltage
TLFM12-CC	12"	25 W	2000 lm	90	2700, 3000, 3500,	120 V
TLFM21-CC	21"	45 W	4300 lm		4000, 5000 K	

---

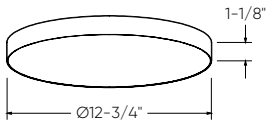
**TLFM12-CC**

---

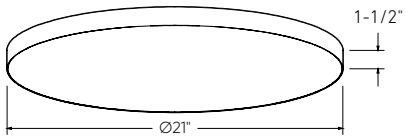
**TLFM21-CC**

---

**Specifications**

Switch-selectable CCT  
Integrated dimmable driver  
Canopy mount on 4" octagon  
junction box  
5-year warranty

---

**Finish**

- **BK** Black
- **WH** White

---

**Note**

Other color temperatures, finishes, and voltage options are available but may require minimum order quantities (MOQs) and longer lead times. Please contact your DALSi representative for more information.

---

# DELTA

Our LED flush mounts incorporate edge-lit technology, eliminating hot spots and glare. With 5 sizes to choose from, every application is covered.

**CFLEDR18-CC**



**CFLEDR06-CC**



**CFLEDR10-CC**



**CFLEDR24-CC**



**CFLEDR14-CC**



NEW



COLOR TEMPERATURE



WET



**T24  
JA8**  
CERTIFIED

CFLEDSQ06-CC

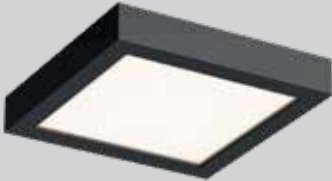

CFLEDSQ10-CC



CFLEDSQ14-CC

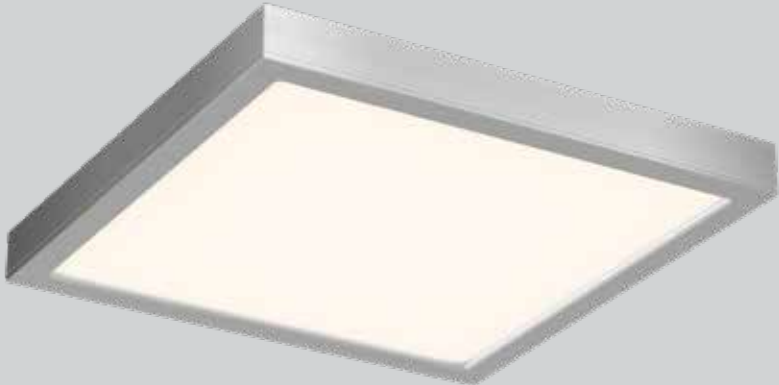

NEW

# DELTA

Our LED flush mounts incorporate edge-lit technology, eliminating hot spots and glare. With 5 sizes to choose from, every application is covered.

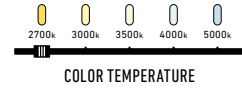

**T24  
JA8**  
CERTIFIED

Model	Size	Watts	Delivered lumens	CRI	Color °T	Voltage options ⚡
CFLEDR06-CC	6"	11 W	700 lm	90	2700, 3000, 3500, 4000, 5000 K	<b>120V TRIAC dimming</b>
CFLEDSQ06-CC*	6"	11 W	700 lm			or
CFLEDR10-CC	10"	17 W	1200 lm			
CFLEDSQ10-CC*	10"	17 W	1200 lm			<b>V: 120 / 277 / 347V</b>
CFLEDR14-CC	14"	26 W	1700 lm			<b>0-10V dimming</b>
CFLEDSQ14-CC*	14"	26 W	1700 lm			(Check for availability)
CFLEDR18-CC	18"	30 W	2100 lm			
CFLEDR24-CC	24"	40 W	3000 lm			

\*Not available in multi-voltage

**CFLEDR06-CC**

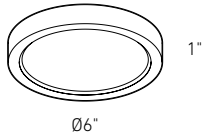

**CFLEDR10-CC**

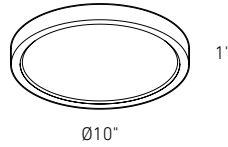

**CFLEDR14-CC**

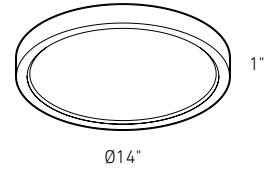

**CFLEDR18-CC**

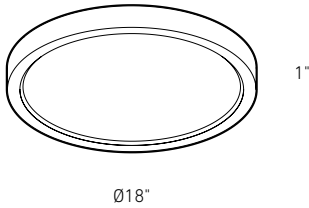

**CFLEDR24-CC**

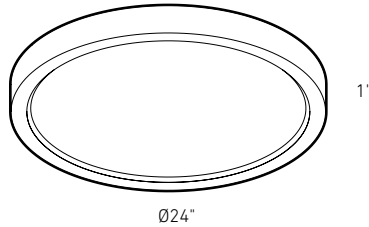

**CFLEDSQ06-CC**

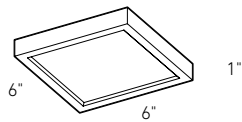

**CFLEDSQ10-CC**

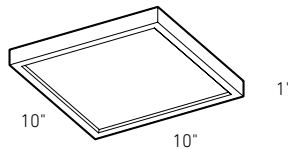

**CFLEDSQ14-CC**

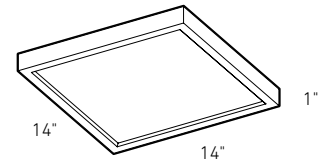

**Specifications**

- Integrated dimmable driver
- Smooth 360° wide spread
- Minimal heat emission
- Frosted lens
- Edge-lit technology
- Cast aluminum construction
- Suitable for outdoor locations on covered ceilings only
- 5-year warranty

**Finish**

- BK** Black
- GD** Gold (6, 10, 14" round models)
- SN** Satin Nickel (6, 10, 14" round and square models)
- WH** White

**Multi-voltage (V) ⚡**

This product family offers multi-voltage drivers (120/277/347) that are dimmable using 0-10V dimming systems. Please note that longer lead times may apply for this option. Kindly reach out to your DALI representative for additional information and to confirm availability.

**Note**

Other color temperatures, finishes, and voltage options are available but may require minimum order quantities (MOQs) and longer lead times. Please contact your DALI representative for more information.

# RADIANCE

The Radiance family features a seamless fusion of refined metal craftsmanship, offering a sophisticated and understated focal point that smoothly integrates into any interior decor.

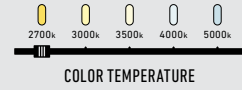

FMM09-CC

FMM12-CC



Model	Size	Watts	Delivered lumens	CRI	Color °T	Voltage
FMM09-CC	9"	14 W	1100 lm	80	2700, 3000, 3500,	120 V
FMM12-CC	12"	20 W	1800 lm		4000, 5000 K	

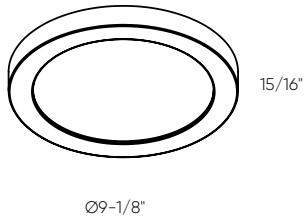

---

**FMM09-CC**

---

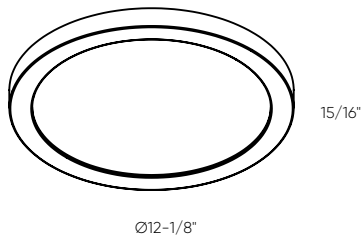
**FMM12-CC**

---

**Specifications**

Switch-selectable CCT  
Integrated dimmable driver  
Suitable for outdoor locations  
on covered ceilings only  
Canopy mount on 4" octagon  
junction box  
5-year warranty

---

**Finish**

- **BK** Black
- **SN** Satin Nickel
- **WH** White

---

**Note**

Other color temperatures, finishes, and voltage options are available but may require minimum order quantities (MOQs) and longer lead times. Please contact your DALs representative for more information.

NEW

# PRIME

These 5-, 9-, and 12-inch flush mount fixtures form a versatile trio, each exuding contemporary design and providing practical illumination. The 5-inch model boasts a variant equipped with a motion sensor, adding a touch of modern convenience to your lighting experience.



COLOR TEMPERATURE

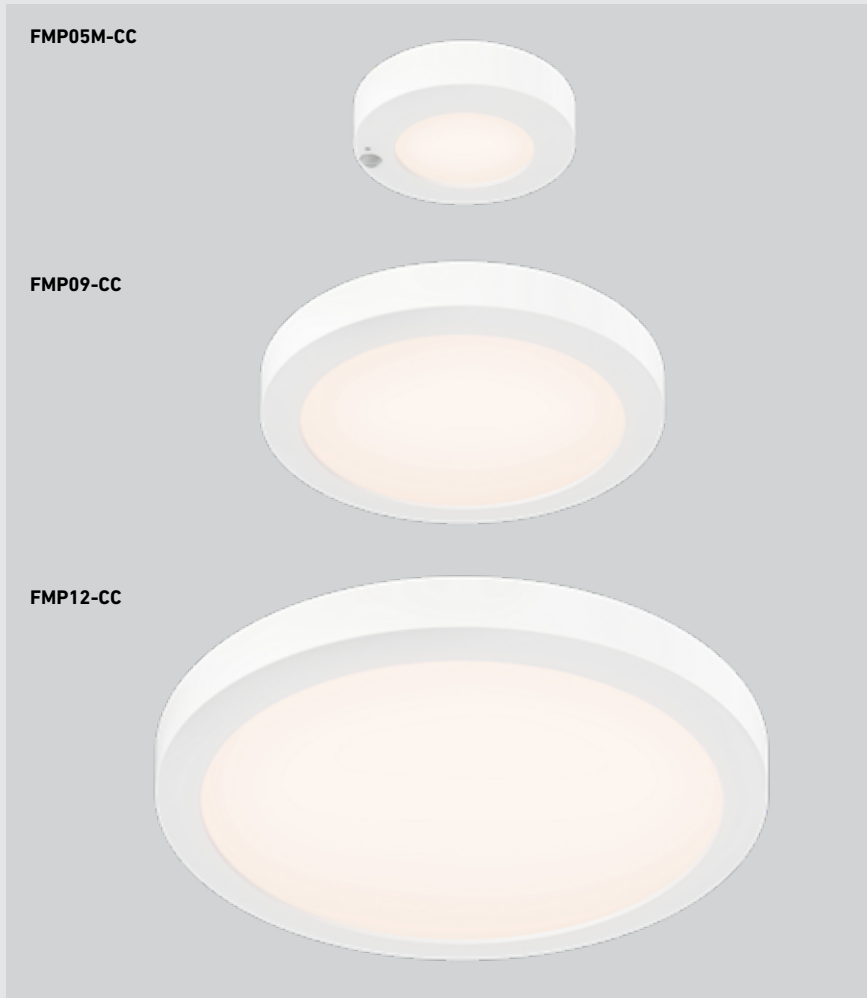

Model	Size	Watts	Delivered lumens	CRI	Color °T	Voltage
FMP05-CC	5"	9 W	600 lm	80	2700, 3000, 3500,	120 V
FMP05M-CC*	5"	9 W	600 lm	80	4000, 5000 K	
FMP05-CC-CR**	5"	9 W	470 lm	90		
FMP09-CC	9"	14 W	1110 lm	80		
FMP09-CC-CR**	9"	14 W	960 lm	90		
FMP12-CC	12"	20 W	1800 lm	80		
FMP12-CC-CR**	12"	20 W	1530 lm	90		

\*Model FMP05M-CC only, non dimmable.

\*\*Models FMP05-CC-CR, FMP09-CC-CR, FMP12-CC-CR only, designed to withstand salty air. 480h salt spray test approved. Equivalent to 6.5 years in coastal environment.

---

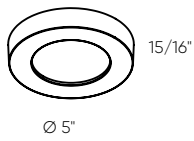
**FMP05-CC, FMP05-CC-CR, FMP05M-CC**

---

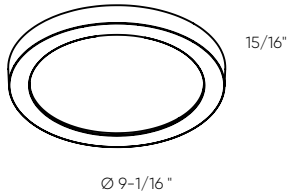
**FMP09-CC, FMP09-CC-CR**

---

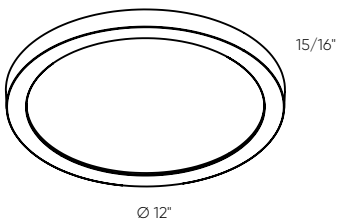
**FMP12-CC, FMP12-CC-CR**

---

**Specifications**

Switch-selectable CCT  
Integrated dimmable driver (models FMP05, FMP09, FMP12-CC only)  
Motion sensor (model FMP05M-CC only)  
Designed to withstand salty air (models FMP05-CC-CR, FMP09-CC-CR, FMP12-CC-CR only)  
5-year warranty

---

**Finish**

○ **WH** White

---

**Note**

Other color temperatures, finishes, and voltage options are available but may require minimum order quantities (MOQs) and longer lead times. Please contact your DALSi representative for more information.

NEW

# SHIFT

A sleek, high-quality LED profile luminaire with direct light output, crafted from durable aluminum extrusion. Its oblong linear head features an efficient 90° swiveling design for versatile lighting.



COLOR TEMPERATURE



DAMP



SWIVEL/DIRECTIONAL

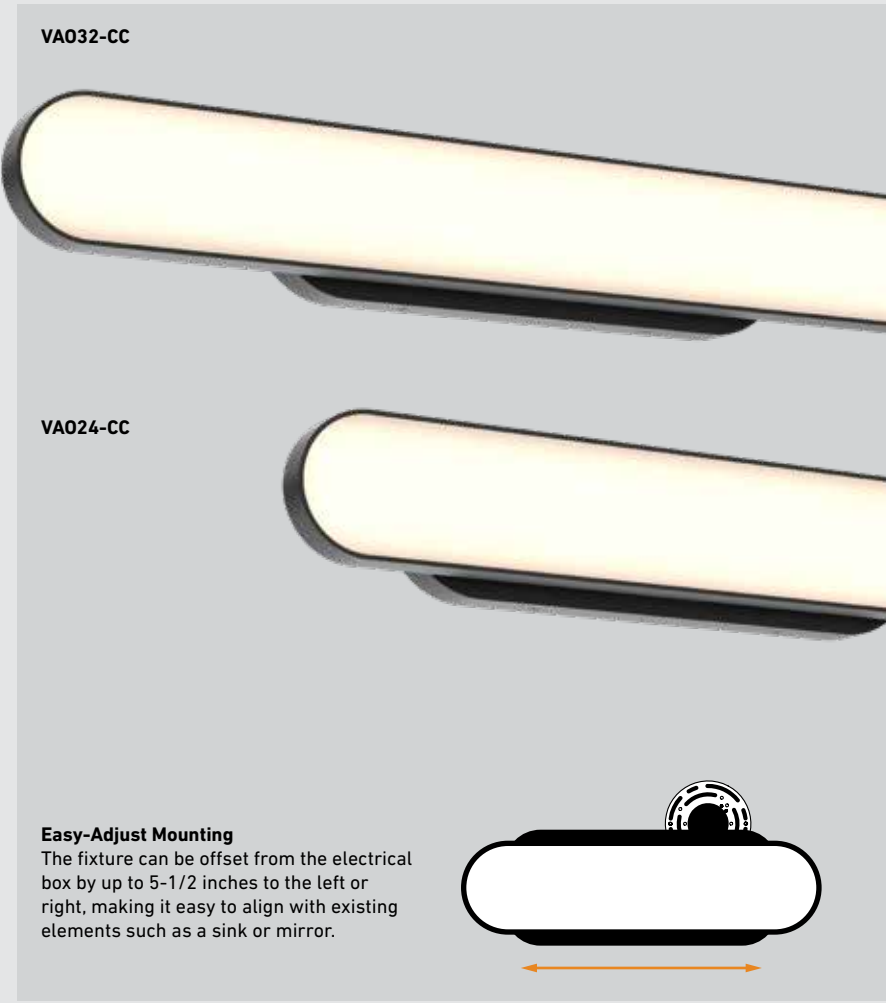

VA032-CC

VA024-CC

### Easy-Adjust Mounting

The fixture can be offset from the electrical box by up to 5-1/2 inches to the left or right, making it easy to align with existing elements such as a sink or mirror.

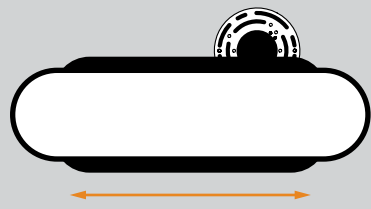

Model	Size	Watts	Delivered lumens	CRI	Color °T	Voltage
VA024-CC	24"	31 W	2470 lm	90	2700, 3000, 3500,	120 V
VA032-CC	32"	34 W	2680 lm		4000, 5000 K	

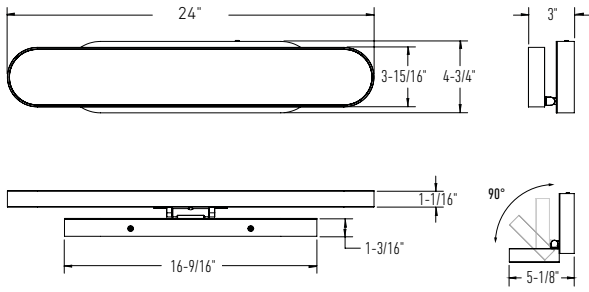
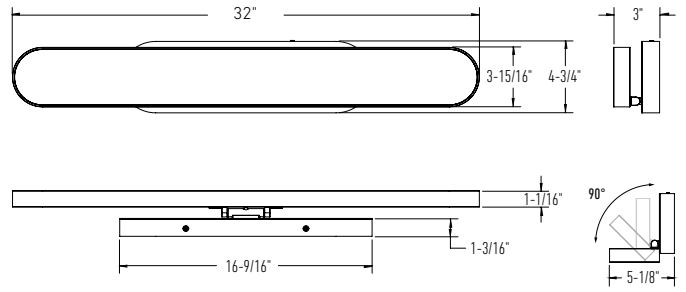
**VA024-CC****VA032-CC****Specifications**

Switch-selectable CCT  
 90 degree swivel  
 Sliding mounting bracket for easy adjustability  
 Integrated dimmable driver  
 Canopy mount on 4" octagon junction box  
 5-year warranty

**Finish**

● **BK** Black  
 ● **GD** Gold

**Note**

Other color temperatures, finishes, and voltage options are available but may require minimum order quantities (MOQs) and longer lead times. Please contact your DALSi representative for more information.

NEW

# LEDGE

A sleek, high-quality LED vanity light with direct illumination, made from sturdy aluminum. Its streamlined linear design provides even, versatile lighting, perfect for modern spaces. Available in two sizes and multiple finishes.

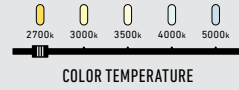

VAL24-CC



VAL36-CC



### Easy-Adjust Mounting

The fixture can be offset from the electrical box by up to 9 1/2 inches (VAL24-CC) or 15 1/2 inches (VAL36-CC) to the left or right, allowing for easy alignment with existing elements such as a sink or mirror.

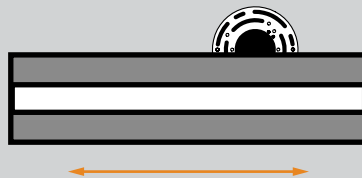

Model	Size	Watts	Delivered lumens	CRI	Color °T	Voltage
VAL24-CC	24"	30 W	2200 lm	90	2700, 3000, 3500, 4000, 5000 K	120 V
VAL36-CC	36"	32 W	2330 lm			

### VAL24-CC

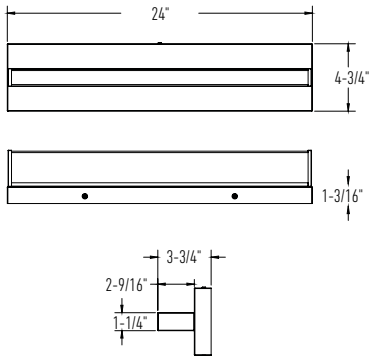

### VAL36-CC

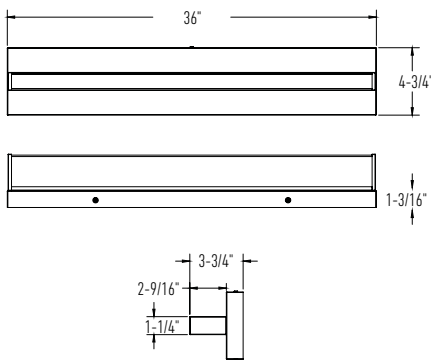

### Specifications

Switch-selectable CCT  
Sliding mounting bracket for easy adjustability  
Integrated dimmable driver  
Canopy mount on 4" octagon junction box  
5-year warranty

### Finish

- **BK** Black
- **CH** Chrome
- **SN** Satin Nickel

### Note

Other color temperatures, finishes, and voltage options are available but may require minimum order quantities (MOQs) and longer lead times. Please contact your DALSi representative for more information.

# BALANCE

Transform your bathroom ambiance with our 24 and 36-inch two-tone vanity light, featuring a stylish interplay of finishes, and complete with an elegant round canopy for a minimalist touch.

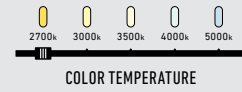

VCC36-CC

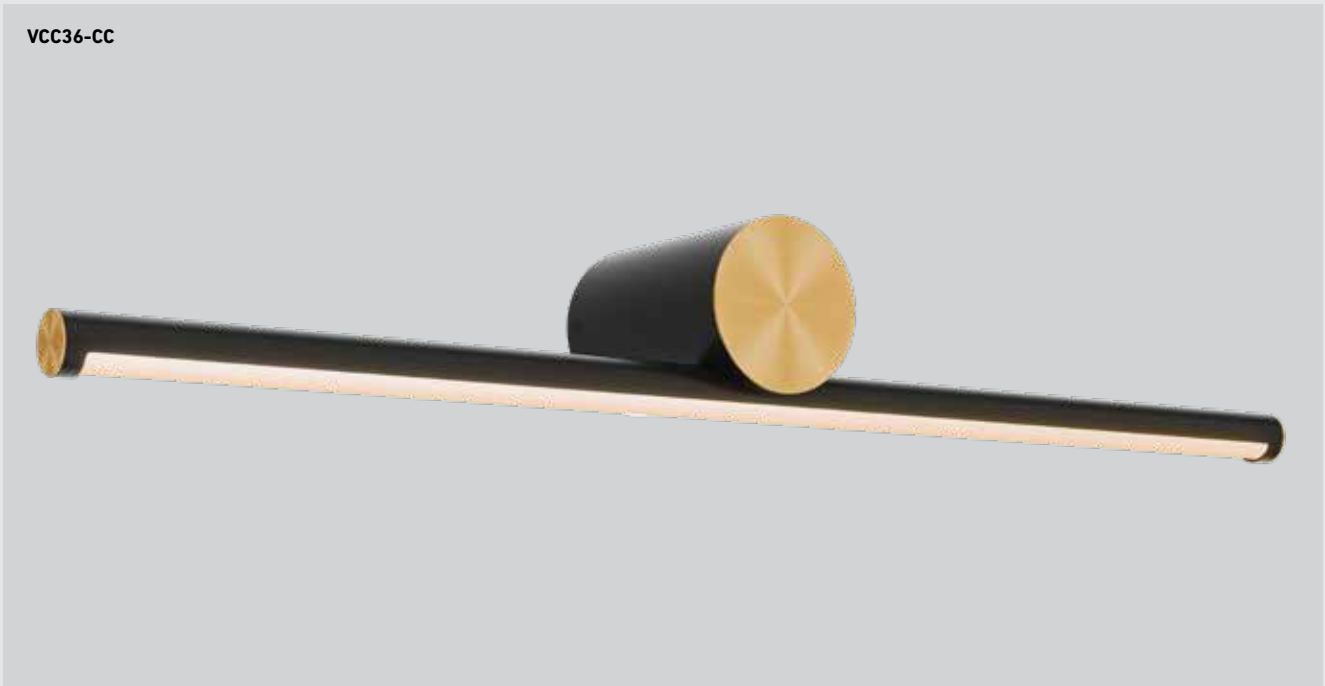

Model	Size	Watts	Delivered lumens	CRI	Color °T	Voltage
VCC24-CC	24"	20 W	1490 lm	90	2700, 3000, 3500,	120 V
VCC36-CC	36"	30 W	1950 lm		4000, 5000 K	



### VCC24-CC

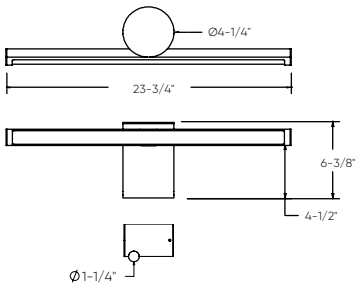

### VCC36-CC

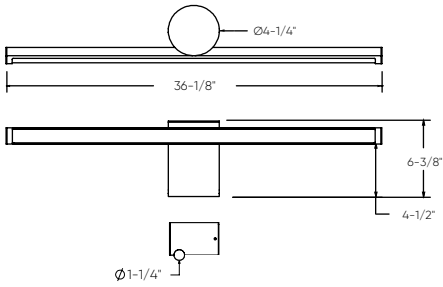

### Specifications

Switch-selectable CCT  
Integrated dimmable driver  
Canopy mount on 4" octagon  
junction box  
5-1/4" decorative disc included  
5-year warranty

### Finish

 **BG** Black/Gold

### Note

Other color temperatures, finishes, and voltage options are available but may require minimum order quantities (MOQs) and longer lead times. Please contact your DALSi representative for more information.

# LIGHTNING

Make a bold statement with this wall-mounted light fixture, featuring a sleek bolt-shaped design that seamlessly combines modern aesthetics with functional elegance. Versatile in its installation, it can also be mounted vertically for a unique lighting experience.

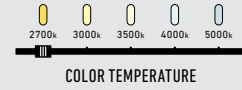

**ADA**  
COMPLIANT



VDL40-CC

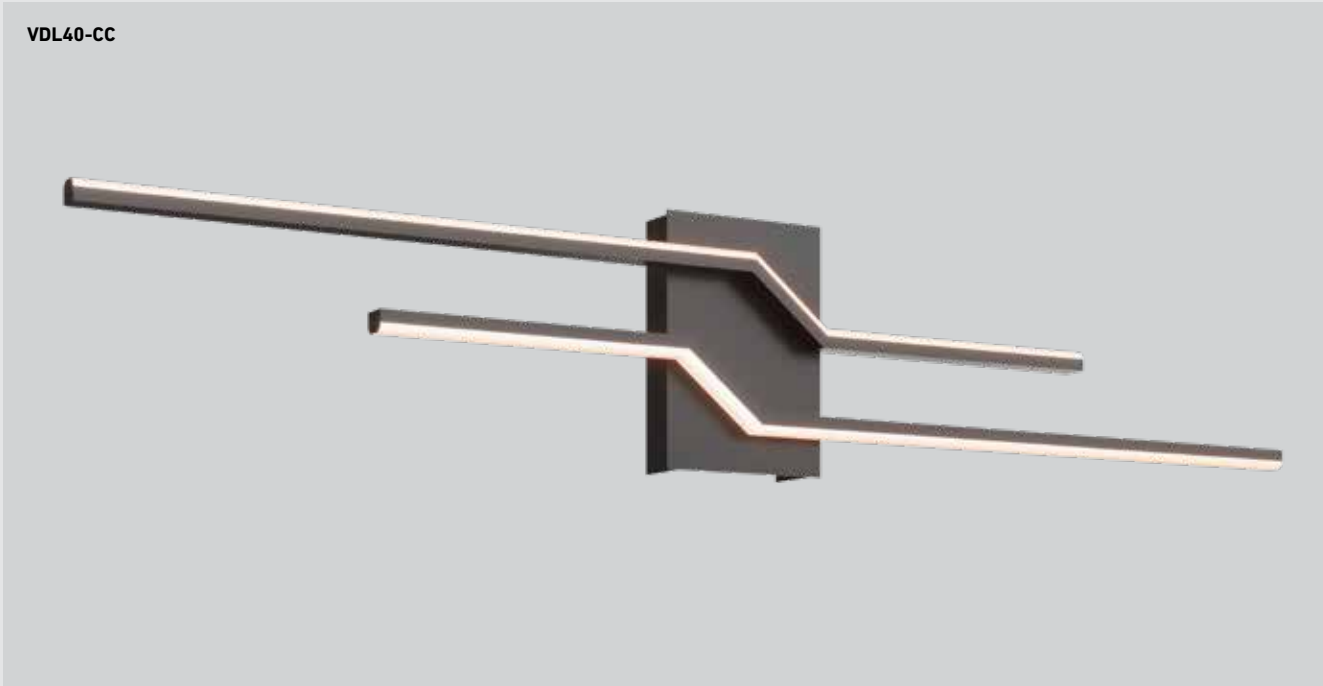

Model	Size	Watts	Delivered lumens	CRI	Color °T	Voltage
VDL40-CC	40"	30 W	1500 lm	80	2700, 3000, 3500, 4000, 5000 K	120 V

## VDL40-CC

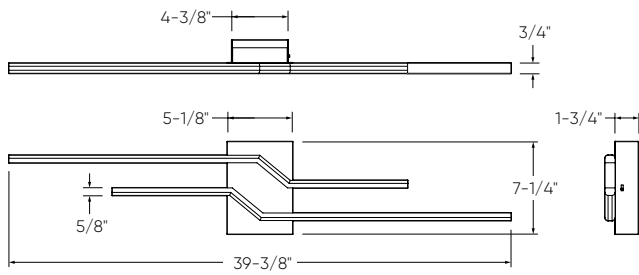

### Specifications

Switch-selectable CCT  
Integrated dimmable driver  
Illuminated canopy  
Canopy mount on 4" octagon  
junction box  
5-year warranty

### Finish

● **BK** Black  
○ **WH** White

### Note

Other color temperatures, finishes, and voltage options are available but may require minimum order quantities (MOQs) and longer lead times. Please contact your DALs representative for more information.

# ARIA

A modern, high-quality LED profile luminaire with direct light emission. Made of an aluminum extrusion and comes with an efficient 120° swiveling linear head.



COLOR TEMPERATURE



DAMP



SWIVEL/DIRECTIONAL

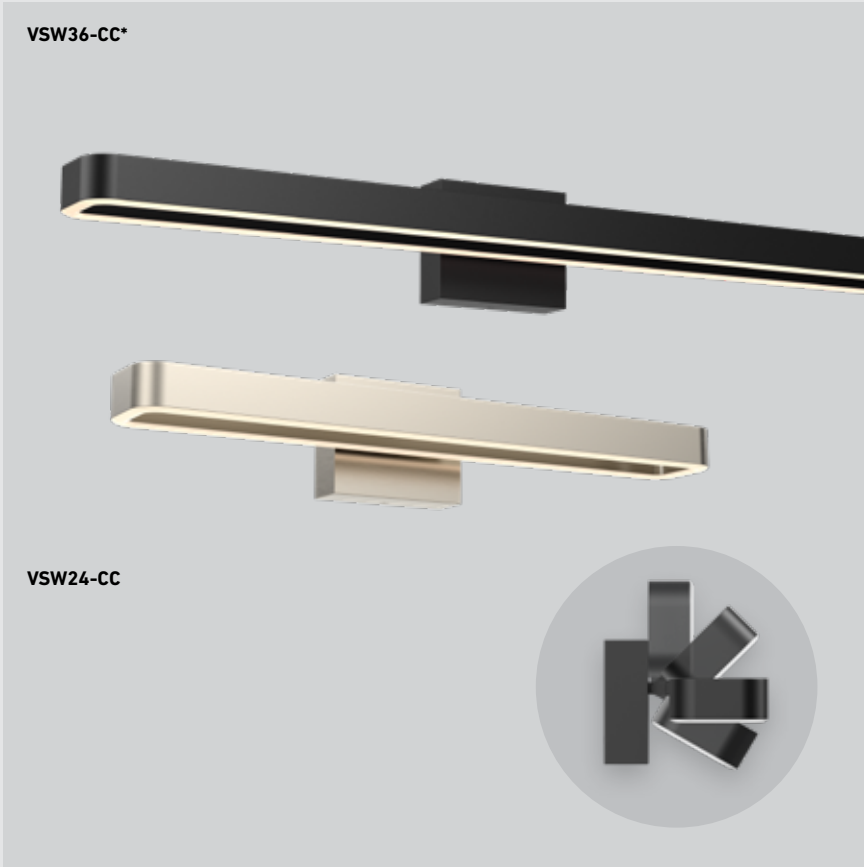

Model	Size	Watts	Delivered lumens	CRI	Color °T	Voltage
VSW24-CC	24"	40 W	1280 lm	90	2700, 3000, 3500,	120 V
VSW36-CC	36"	40 W	1500 lm		4000, 5000 K	

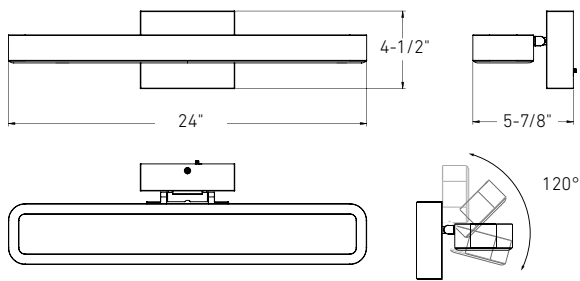
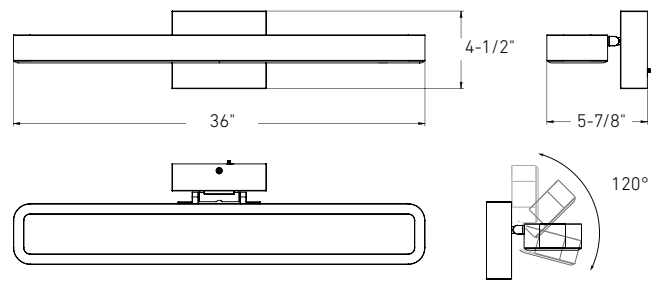
**VSW24-CC****VSW36-CC****Specifications**

Superior color consistency  
 Integrated dimmable driver  
 Switch-selectable CCT  
 Minimal heat emission  
 Aluminum construction  
 120 degree swivel  
 5-year warranty

**Finish**

- **BK** Black
- **SN** Satin Nickel (VSW24-CC only)

**Note**

Other color temperatures, finishes, and voltage options are available but may require minimum order quantities (MOQs) and longer lead times. Please contact your DALs representative for more information.

# NOBLE ONE

The flexibility of our LED vanity will give you many options to work with. It can be installed in a horizontal or vertical direction, and is available in 3 finishes.

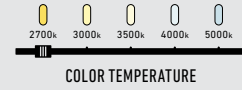

**ADA**  
COMPLIANT



LEDVAN001-CC-18

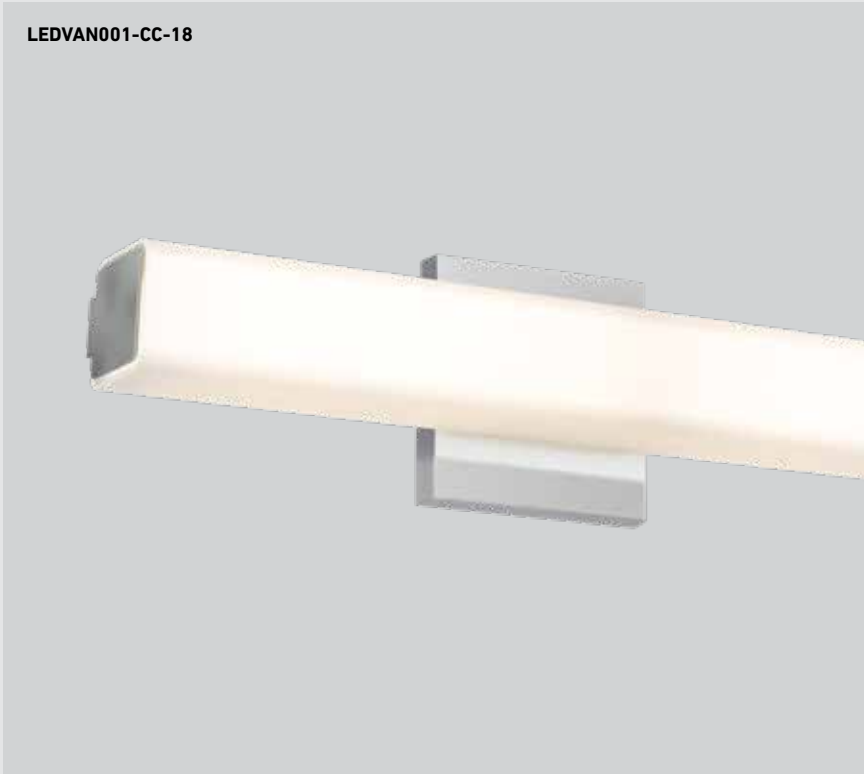

Model	Size	Watts	Delivered lumens	CRI	Color °T	Voltage
LEDVAN001-CC-18	18"	16 W	1000 lm	90	2700, 3000, 3500,	120 V
LEDVAN001-CC-24	24"	24 W	1600 lm		4000, 5000 K	



**LEDVAN001-CC-18**

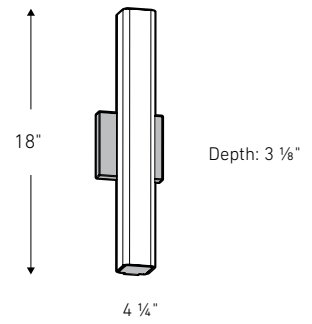

**LEDVAN001-CC-24**

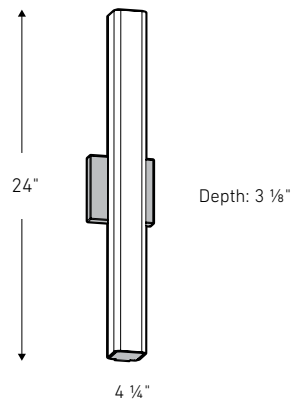

**Specifications**

- Switch-selectable CCT:
- Square frosted glass lens
- Superior color consistency
- Integrated dimmable direct-AC LED technology
- 5-year warranty

**Finish**

- **BK** Black
- **CH** Chrome
- **SN** Satin Nickel

**Note**

Other color temperatures, finishes, and voltage options are available but may require minimum order quantities (MOQs) and longer lead times. Please contact your DALs representative for more information.

# NOBLE TWO

The flexibility of our LED vanity will give you many options to work with. It can be installed horizontally or vertically, and is available in 3 finishes.

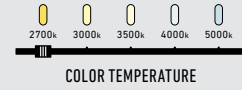

**ADA**  
COMPLIANT



LEDVAN002-CC-24



Model	Size	Watts	Delivered lumens	CRI	Color °T	Voltage
LEDVAN002-CC-24	24"	24 W	1525 lm	90	2700, 3000, 3500,	120 V
LEDVAN002-CC-36	36"	32 W	2050 lm		4000, 5000 K	



**LEDVAN002-CC-24**

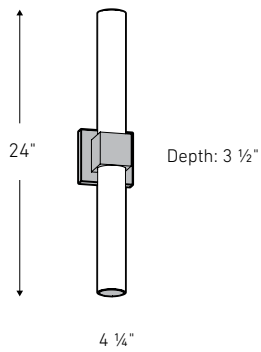

**LEDVAN002-CC-36**

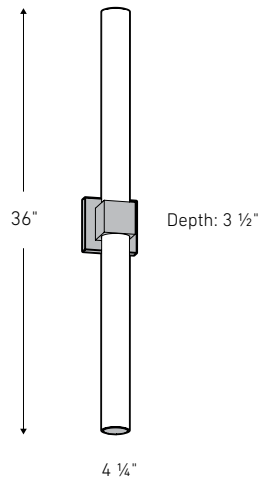

**Specifications**

Switch-selectable CCT  
Round frosted glass lens  
Integrated dimmable direct AC  
LED technology  
5-year warranty

**Finish**

- **BK** Black
- **CH** Chrome
- **SN** Satin Nickel

**Note**

Other color temperatures, finishes, and voltage options are available but may require minimum order quantities (MOQs) and longer lead times. Please contact your DALs representative for more information.

# LYRA

These modern LED vanity lights can be installed in 2 directions; horizontal or vertical based on your desired lighting layout. Let your imagination go.

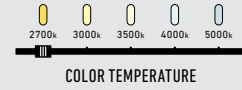

**ADA**  
COMPLIANT

**T24**  
**JA8**  
CERTIFIED

**LEDVAN003-CC-24**

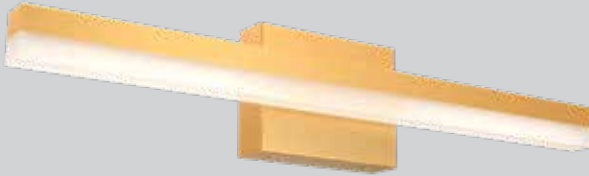

**LEDVAN003-CC-32**



Model	Size	Watts	Delivered lumens	CRI	Color °T	Voltage
<b>LEDVAN003-CC-24</b>	24"	23 W	1900 lm	90	2700, 3000, 3500, 4000, 5000 K	120 V
<b>LEDVAN003-CC-32</b>	32"	38 W	2800 lm			

**LEDVAN003-CC-24**

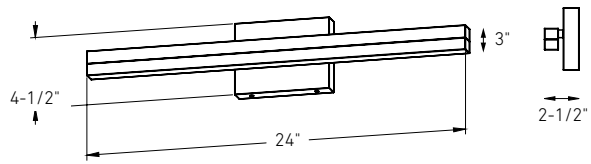

**LEDVAN003-CC-32**

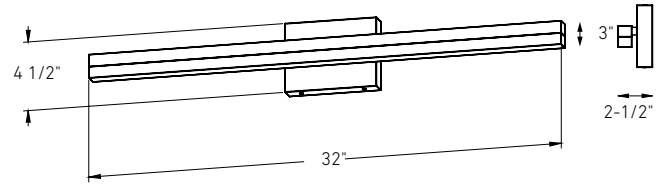

**Specifications**

- Switch-selectable CCT
- Superior color consistency
- Integrated dimmable driver
- 5-year warranty

**Finish**

- BK** Black
- CH** Chrome
- GD** Gold
- SN** Satin Nickel

**Note**

Other color temperatures, finishes, and voltage options are available but may require minimum order quantities (MOQs) and longer lead times. Please contact your DALs representative for more information.

# PORTRAIT

Upgrade your living space with our versatile directional vanity light, suitable for any room. This fixture allows you to point the light in any direction, providing both functionality and style for a modern touch.



COLOR TEMPERATURE



DAMP



180°  
SWIVEL/DIRECTIONAL

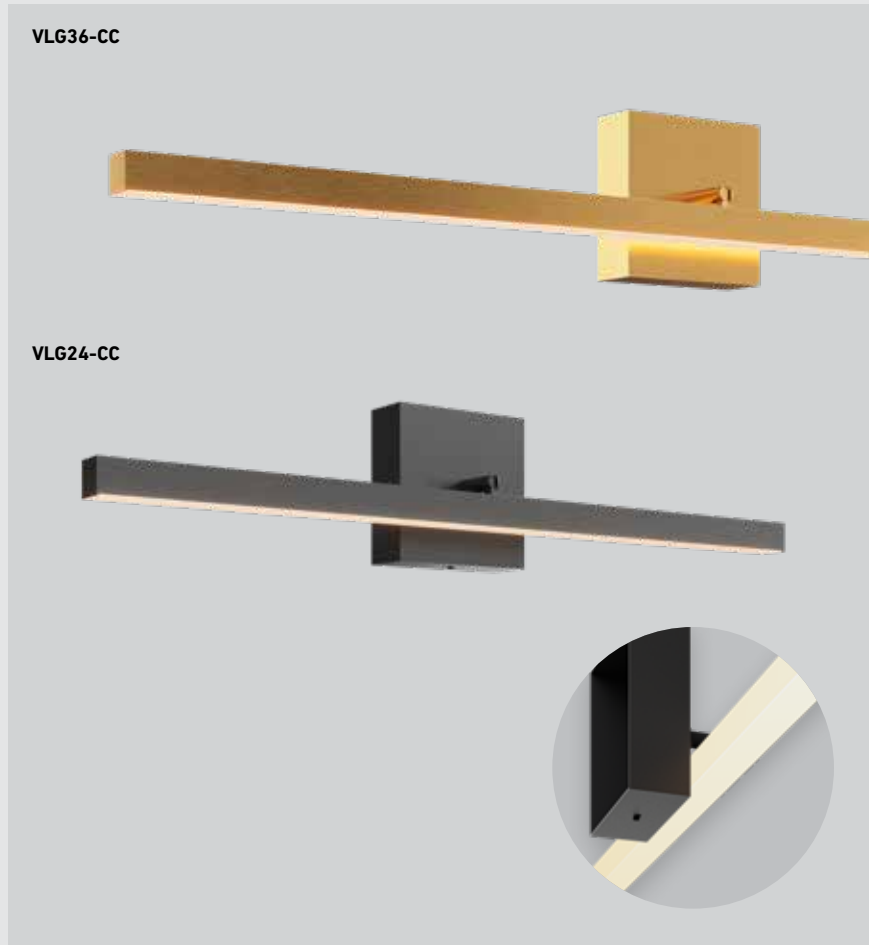

Model	Size	Watts	Delivered lumens	CRI	Color °T	Voltage
VLG24-CC	24"	16 W	1100 lm	80	2700, 3000, 3500, 4000, 5000 K	120 V
VLG36-CC	36"	26 W	1400 lm			

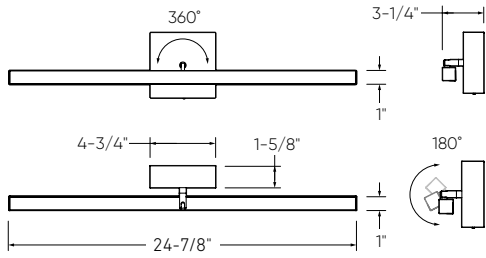
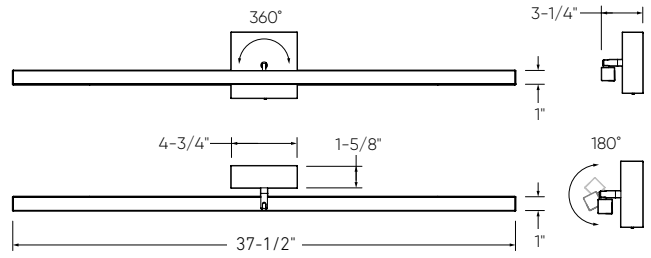
**VLG24-CC****VLG36-CC****Specifications**

Switch-selectable CCT  
 Integrated dimmable driver  
 360° rotation, 180° swivel  
 Multi-directional lighting with light coming from below and behind the luminaire  
 Canopy mount on 4" octagon junction box  
 5-year warranty

**Finish**

- **BK** Black
- **GD** Gold
- **SN** Satin Nickel
- **WH** White

**Note**

Other color temperatures, finishes, and voltage options are available but may require minimum order quantities (MOQs) and longer lead times. Please contact your DALI representative for more information.

# GEMINI

This sleek design truly utilizes the best features of LED technology. We are now able to create a unique form factor that will project the perfect amount of light.

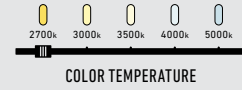

**ADA**  
COMPLIANT

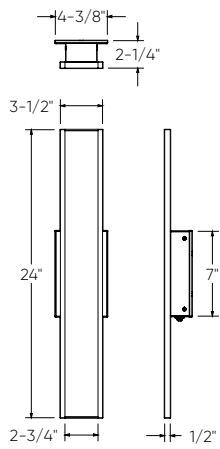
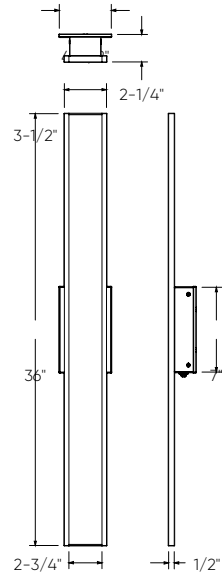
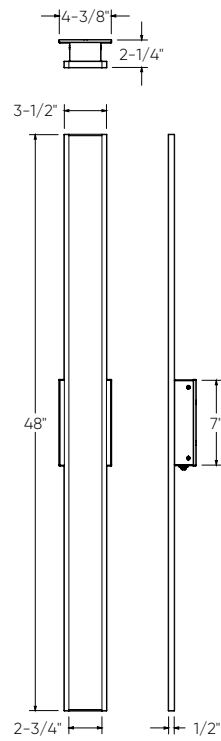
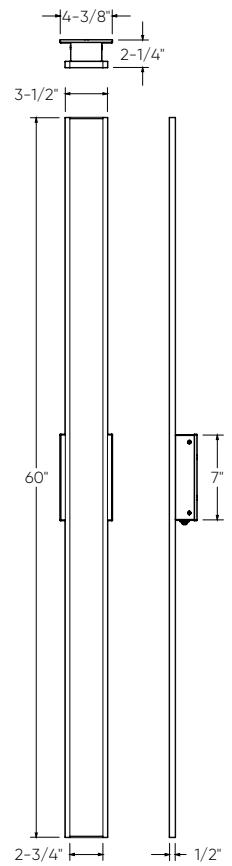

Model	Size	Watts	Delivered lumens	CRI	Color °T	Voltage
SWS24-CC	24"	20 W	900 lm	90	2700, 3000, 3500, 4000, 5000 K	120 V
SWS36-CC	36"	30 W	1600 lm			
SWS48-CC	48"	40 W	1900 lm			
SWS60-CC	60"	50 W	2300 lm			

**SWS24-CC****SWS36-CC****SWS48-CC****SWS60-CC****Specifications**

Switch-selectable CCT  
 Integrated dimmable driver  
 Compatible with TRIAC and ELV dimmers  
 5-year warranty

**Finish**

● **BK** Black

**Note**

Other color temperatures, finishes, and voltage options are available but may require minimum order quantities (MOQs) and longer lead times. Please contact your DALI representative for more information.

# MIDNIGHT

The 24-inch indirect linear wall sconce emanates a soft, ambient glow, elegantly transforming any space with its sleek design. Get creative with its versatile mounting options, allowing it to be installed in a clock-like manner, offering a customizable lighting solution.

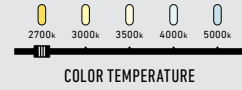
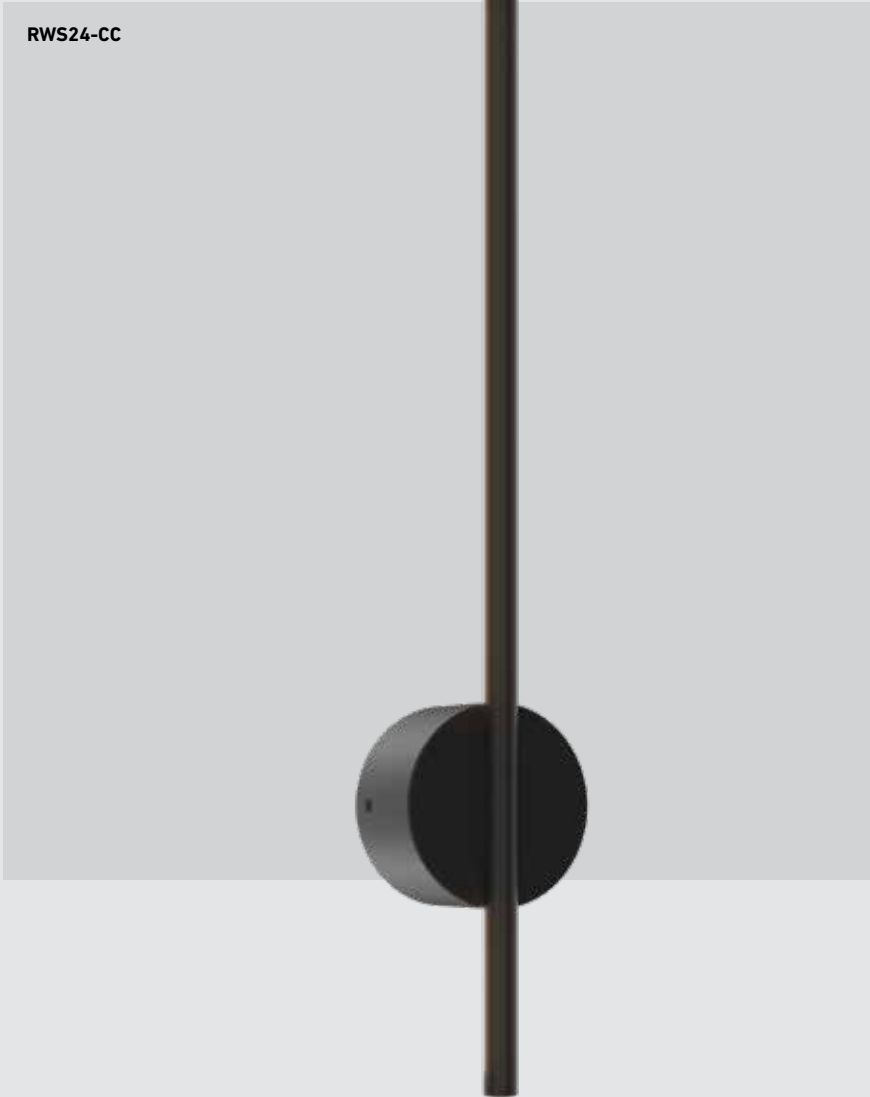

**ADA**  
COMPLIANT



Model	Size	Watts	Delivered lumens	CRI	Color °T	Voltage
RWS24-CC	24"	6 W	400 lm	80	2700, 3000, 3500, 4000, 5000 K	120 V
RWS48-CC	48"	14 W	1000 lm			
RWS60-CC	60"	17 W	1400 lm			

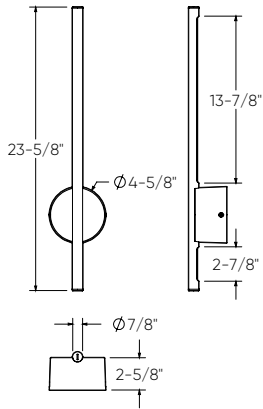
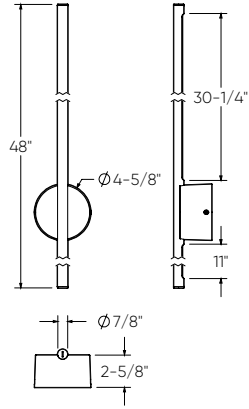
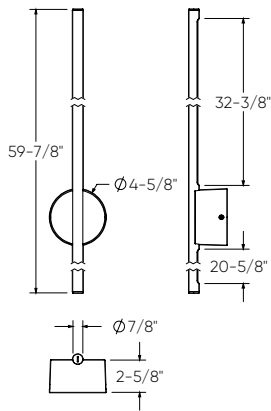

**RWS24-CC****RWS48-CC****RWS60-CC****Specifications**

Switch-selectable CCT  
 Integrated dimmable driver  
 Wall mount on 4" octagon  
 junction box  
 5-year warranty

**Finish**

● **BK** Black

**Note**

Other color temperatures, finishes, and voltage options are available but may require minimum order quantities (MOQs) and longer lead times. Please contact your DALI representative for more information.





# PROFILE

Love at first sight, guaranteed. This will not only give you up and down lighting but also central through a delicate acrylic opening. Want to adapt your lighting to your environment? No problem. This wall mount has five color temperatures to choose from which makes it ideal for city or country living.

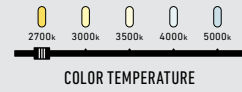

Model	Size	Watts	Delivered lumens	CRI	Color °T	Voltage
LWJ08-CC	8"	10 W	390 lm	90	2700, 3000, 3500, 4000, 5000 K	120 V
LWJ16-CC	16"	20 W	760 lm			
LWJ24-CC	24"	45 W	2345 lm			



**LWJ08-CC**

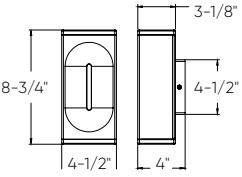

**LWJ16-CC**

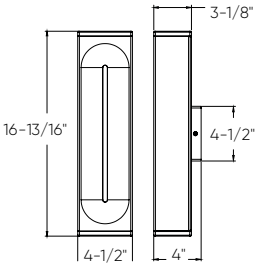

**LWJ24-CC**

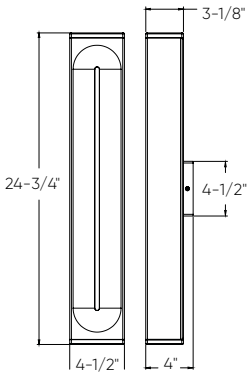

**Specifications**

- Made of extruded aluminum
- Unique up, down, and center lighting output
- Low profile design
- Switch-selectable CCT
- Integrated dimmable driver
- 5-year warranty

**Finish**

- BK Black
- WH White (LWJ16-CC only)

**Note**

Other color temperatures, finishes, and voltage options are available but may require minimum order quantities (MOQs) and longer lead times. Please contact your DALs representative for more information.

# ADEN

The key design element of our LED cylinder is the removable lens. This feature allows for three distinctive styles during installation.



LEDWALL-A

3000k

COLOR TEMPERATURE



WET

**ADA**  
COMPLIANT

**T24**  
**JA8**  
CERTIFIED



Model	Size	Watts	Delivered lumens	CRI	Color °T	Voltage
LEDWALL-A	11-3/4"	29 W	2100 lm	90	3000 K	120 V - 277 V



## LEDWALL-A

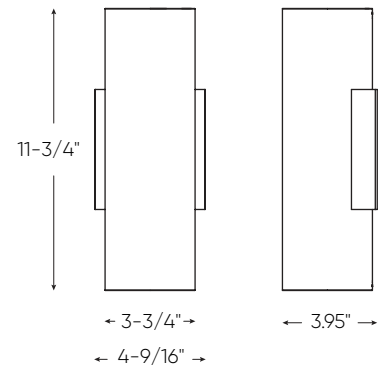

### Specifications

Cylindrical housing made of extruded aluminum

Cylinder comes with 3 optical options:

- Bright aluminum reflector that provides a 45° beam spread
- Frosted glass lens to allow a wider beam spread
- Die-cast aluminum cap to allow a down light only version

Baked powder paint coat for a highly durable finish

5-year warranty

### Finish

- **BK** Black

### Note

Other color temperatures, finishes, and voltage options are available but may require minimum order quantities (MOQs) and longer lead times. Please contact your DALSi representative for more information.



# BROOKLYN

The key design element of our LED square cylinder is the removable lens, which allows for three distinctive styles during installation.



LEDWALL-B

3000k

COLOR TEMPERATURE



WET

ADA  
COMPLIANT

T24  
JA8  
CERTIFIED



Model	Size	Watts	Delivered lumens	CRI	Color °T	Voltage
LEDWALL-B	11-3/4"	28 W	2100 lm	90	3000 K	120 V - 277 V



## LEDWALL-B

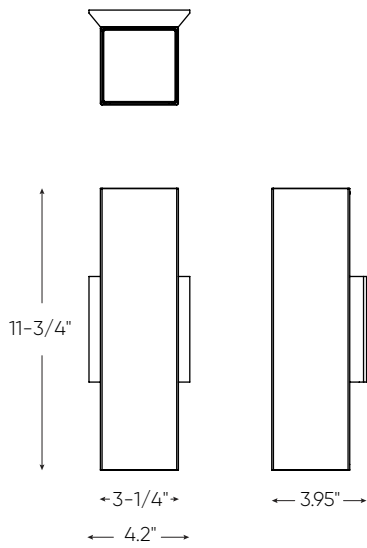

### Specifications

Cylindrical housing made of extruded aluminum

Cylinder comes with 3 optical options:

- Bright aluminum reflector that provides a 45° beam spread
- Frosted glass lens to allow a wider beam spread
- Die-cast aluminum cap to allow a down light only version

Baked powder paint coat for a highly durable finish

5-year warranty

### Finish

- **BK** Black
- **WH** White

### Note

Other color temperatures, finishes, and voltage options are available but may require minimum order quantities (MOQs) and longer lead times. Please contact your DALI representative for more information.

# EDINBURGH

European inspiration is made prevalent in this LED wall mount. Indirect lighting allows for a uniform and even light output that will enhance every application.



3000k

COLOR TEMPERATURE



WET

**ADA**  
COMPLIANT



Model	Size	Watts	Delivered lumens	CRI	Color °T	Voltage
LEDWALL-E	13-3/4"	12 W	870 lm	90	3000 K	120 V



## LEDWALL-E

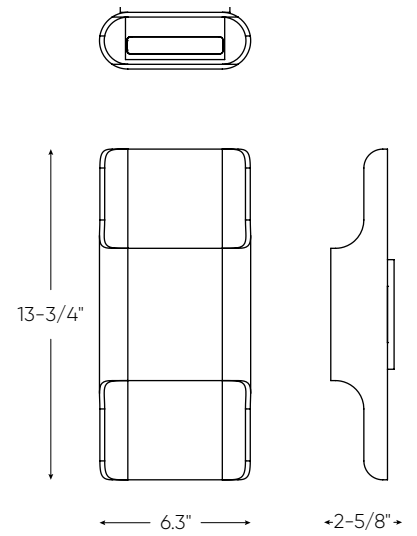

### Specifications

Made of extruded aluminum  
Fully sealed light engine  
Unique up and down lighting output  
Low profile design  
Integrated dimmable driver  
5-year warranty

### Finish

● **BK** Black

### Note

Other color temperatures, finishes, and voltage options are available but may require minimum order quantities (MOQs) and longer lead times. Please contact your DALSi representative for more information.

NEW

# SHIELD

These 5" and 7" dark-sky friendly wall fixtures offer focused, energy-efficient illumination while minimizing light pollution, making them ideal for environmentally conscious outdoor spaces.



COLOR TEMPERATURE



WET



DARK SKY FRIENDLY



PHOTOCELL



DSWC05-CC

DSWC07-CC-V



### Photocell

The photocell feature automatically adjusts to changing light conditions, providing energy-efficient illumination without requiring manual control.

Model	Size	Watts	Delivered lumens	CRI	Color °T	Voltage
DSWC05-CC	5"	16 W	1200 lm	90	2700, 3000, 3500, 4000, 5000 K	120 V
DSWC07-CC-V	7"	24 W	2000 lm	90	2700, 3000, 3500, 4000, 5000 K	V: 120 / 277 / 347V 0-10V dimming

**DSWC05-CC**

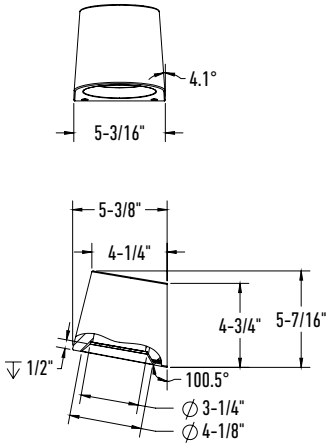

**DSWC07-CC-V**

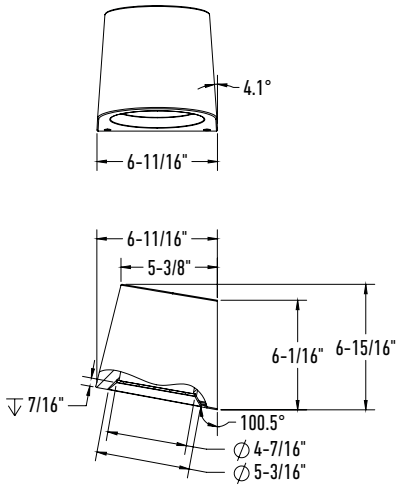

**Specifications**

- Die-cast aluminum housing
- Switch-selectable CCT
- Integrated photocell for automatic lighting control
- Integrated dimmable driver
- Installs in a standard electrical junction box
- 5-year warranty

**Finish**

- **BK** Black

**Note**

Other color temperatures, finishes, and voltage options are available but may require minimum order quantities (MOQs) and longer lead times. Please contact your DALs representative for more information.

# GENEVA

Imagine being able to manually control the amount of light spread coming from both the top and bottom of your lighting fixture. This is now possible with our LED wall mount.

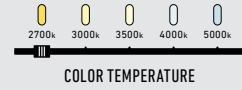

**ADA**  
COMPLIANT



LEDWALL-G-CC



Model	Size	Watts	Delivered lumens	CRI	Color °T	Voltage
LEDWALL-G-CC	4-1/2"	14 W	600 lm	90	2700, 3000, 3500, 4000, 5000 K	120 V





### Specifications

- Made of extruded aluminum
- Separately adjustable up and down lighting
- Easily adjustable lighting angle from 0° to 92°
- Superior color consistency
- Directional lighting
- Integrated dimmable driver
- 5-year warranty

### Finish

- **BK** Black
- **WH** White

### Note

Other color temperatures, finishes, and voltage options are available but may require minimum order quantities (MOQs) and longer lead times. Please contact your DALIS representative for more information.

### LEDWALL-G-CC

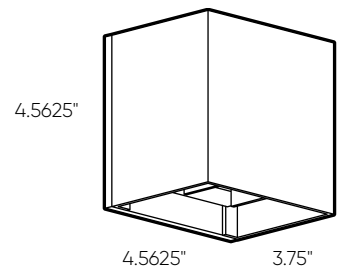

# HARLOW

This distinctive LED wall-mounted sconce permeates a gentle multi-directional light. Its unique geometric shape and robust design will provide a dramatic flare to any indoor/outdoor space. Ideal for residential and commercial projects, its warm splashes of light create an impressive architectural and alluring touch.



3000k

COLOR TEMPERATURE



WET

ADA  
COMPLIANT



Model	Size	Watts	Delivered lumens	CRI	Color °T	Voltage
LEDWALL-H	6"	15 W	900 lm	90	3000 K	120 V





**Specifications**

- Made of extruded aluminum
- Fully sealed light engine
- Unique up and down lighting output
- Integrated dimmable driver
- 5-year warranty

**Finish**

- **BK** Black

**Note**

Other color temperatures, finishes, and voltage options are available but may require minimum order quantities (MOQs) and longer lead times. Please contact your DALI representative for more information.

**LEDWALL-H**

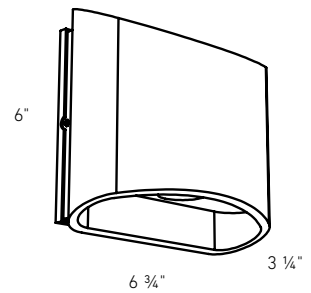

# ALTO

The Alto blends light functionality with an opportunity for artistic creation. Combine multiple fixtures to create infinite compositions or simply use alone, the choice is yours.

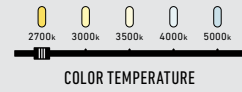

**ADA**  
COMPLIANT\*



Model	Size	Watts	Delivered lumens	CRI	Color °T	Voltage
SQS06-CC*	6"	8.5 W	550 lm	90	2700, 3000, 3500, 4000, 5000 K	120 V
SQS10-CC*	10"	13 W	800 lm			
SQSTP-CC	6"	3 W	190 lm			

---

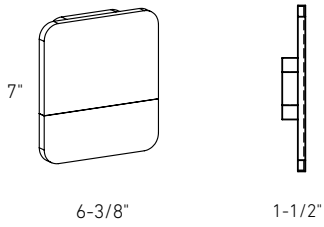
**SQS06**

---

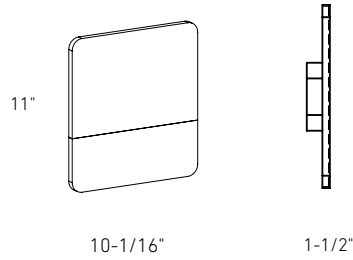
**SQS10**

---

**SQSXX-NUM**

**0123456789**  
**0123456789**  
**0123456789**  
**0123456789**  
**0123456789**  
**- ABCDEFGH**  
**IJKLMNOPQ**  
**RSTUVWXYZ**

---

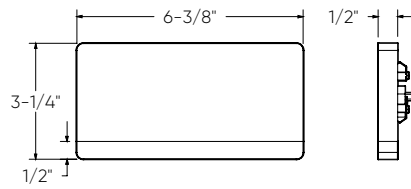
**SQSTP-CC**

---

**Specifications**

Cast aluminum construction  
 Black adhesive character set included with wall sconce only  
 Low profile design  
 Switch-selectable CCT  
 Integrated dimmable driver  
 5-year warranty

---

**Finish**

- **BK** Black
- **WH** White (model SQSTP-CC only)

---

**Accessories****SQS06-NUM-BK**

An adhesive set of 50 numbers and 27 characters for the SQS06 wall sconce

**SQS10-NUM-BK**

An adhesive set of 50 numbers and 27 characters for the SQS10 wall sconce

---

**Note**

Other color temperatures, finishes, and voltage options are available but may require minimum order quantities (MOQs) and longer lead times. Please contact your DALI representative for more information.

# CUBIX

Imagine being able to manually control the amount of light spread coming out from both the top and bottom of your lighting fixture. This is now possible with our LED wall mount.



COLOR TEMPERATURE



LEDWALL001D-CC



Model	Size	Watts	Delivered lumens	CRI	Color °T	Voltage
LEDWALL001D-CC	4"	7 W	540 lm	90	2700, 3000, 3500, 4000, 5000 K	120 V



**Specifications**

- Up and down lighting
- Easily adjustable lighting angle from 0° to 92°
- Integrated dimmable driver
- 5-year warranty

**Finish**

- **BK** Black
- **WH** White

**Note**

Other color temperatures, finishes, and voltage options are available but may require minimum order quantities (MOQs) and longer lead times. Please contact your DALs representative for more information.

**LEDWALL001D-CC**

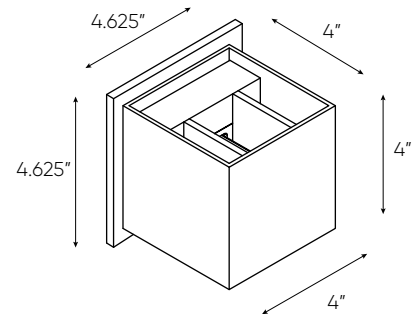

NEW

# RISE

This 12" horizontal step light features a streamlined design, offering both uniform illumination and a modern, minimalist aesthetic for stairways and pathways.

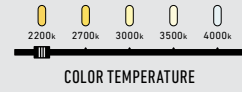

LSTP12-CC



Model	Size	Watts	Delivered lumens	CRI	Color °T	Voltage
LSTP12-CC	12"	10 W	300 lm	90	2200, 2700, 3000, 3500, 4000 K	120 V





### Specifications

Die-cast aluminum housing  
 Switch-selectable CCT  
 Integrated dimmable driver  
 Fits in 2x3 junction boxes or octagonal  
 junction boxes  
 5-year warranty

### Finish

● **BK** Black

### Note

Other color temperatures, finishes, and  
 voltage options are available but may require  
 minimum order quantities (MOQs) and  
 longer lead times. Please contact your DALs  
 representative for more information.

### LSTP12-CC

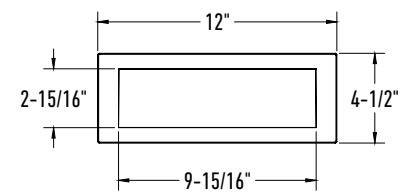

# ECHO

Inspiration will come in abundance once you try our LED accent step lights. Use them outdoors on your deck or on the stairs inside your home. You will be truly impressed by the effect!

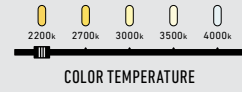

LEDSTEP002D-CC



Model	Size	Watts	Delivered lumens	CRI	Color °T	Voltage
LEDSTEP002D-CC	4-3/4"	3 W	75 lm	90	2200, 2700, 3000, 3500, 4000 K	120 V





### Specifications

Die-cast aluminum housing  
 Switch-selectable CCT  
 Integrated dimmable driver  
 Install in standard electrical junction box  
 Ideal operating temperature:  
 -20° to 40° C  
 5-year warranty

### Finish

- **BK** Black
- **WH** White

### Note

Other color temperatures, finishes, and voltage options are available but may require minimum order quantities (MOQs) and longer lead times. Please contact your DALs representative for more information.

### LEDSTEP002D-CC

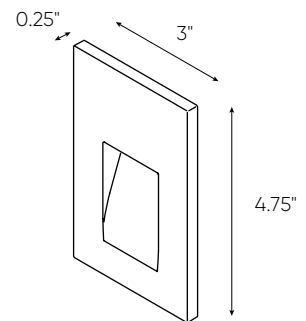

# PEARL

The simplicity of this design allows for the highest level of flexibility when choosing your application. Light glowing from all directions creates the perfect ambiance for every setting.



COLOR TEMPERATURE



WET



LEDSTEP004D-CC



Model	Size	Watts	Delivered lumens	CRI	Color °T	Voltage
LEDSTEP004D-CC	3-1/4"	3 W	50 lm	90	2200, 2700, 3000, 3500, 4000 K	120 V



## LEDSTEP004D-CC

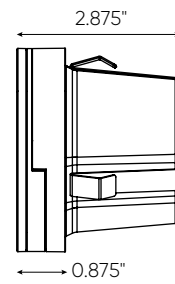
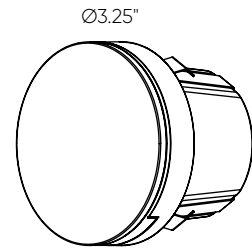

### Specifications

Die-cast aluminum housing  
 Switch-selectable CCT  
 Integrated dimmable driver  
 Includes a junction box approved for concrete applications  
 5-year warranty

### Finish

● **BK** Black  
 ○ **WH** White

### Note

Other color temperatures, finishes, and voltage options are available but may require minimum order quantities (MOQs) and longer lead times. Please contact your DALs representative for more information.

# CAMBER

The innovation of this design comes from its recessed installation. This step light will be perfectly integrated into stairs and can also be used on decks.



COLOR TEMPERATURE



LEDSTEP005D-CC



Model	Size	Watts	Delivered lumens	CRI	Color °T	Voltage
LEDSTEP005D-CC	4-3/4"	3 W	90 lm	90	2200, 2700, 3000, 3500, 4000 K	120 V

---

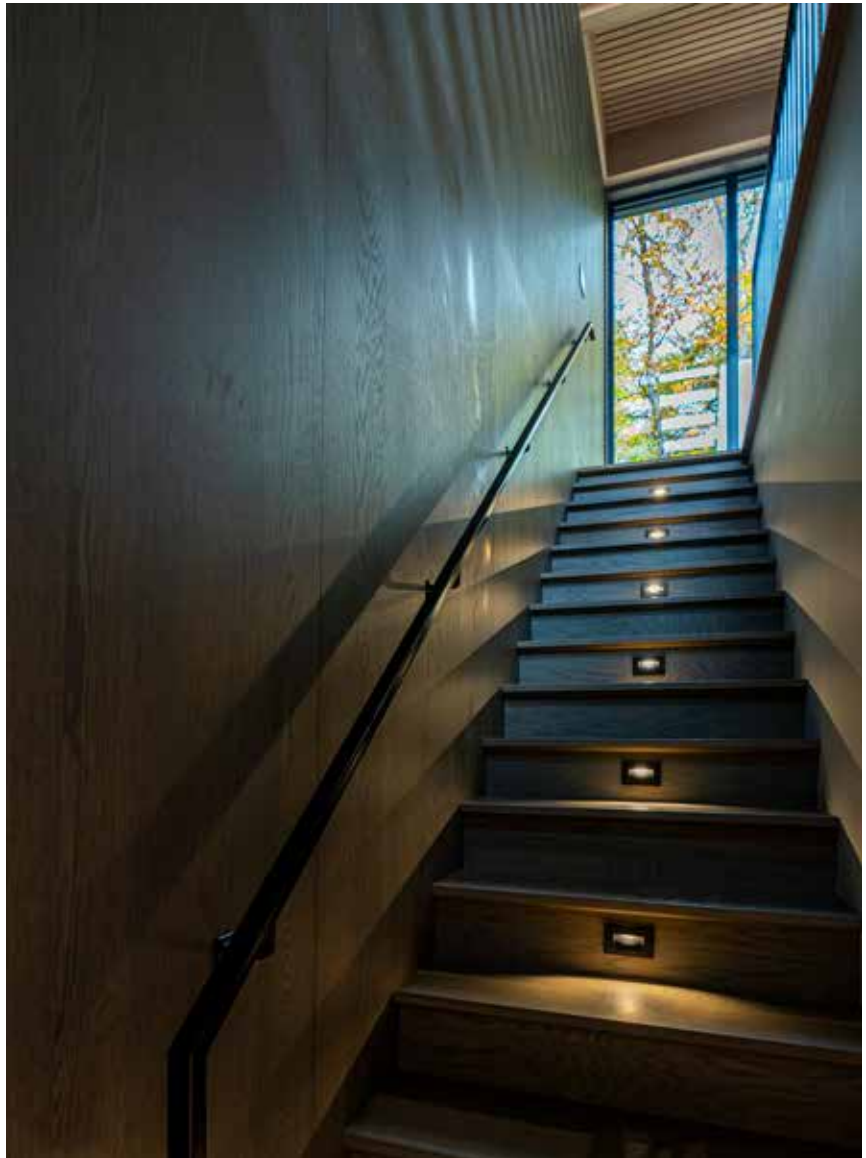
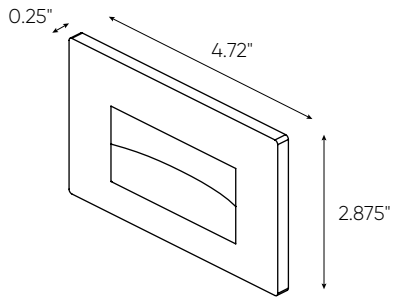
**LEDSTEP005D-CC**

---

**Specifications**

Die-cast aluminum housing  
Switch-selectable CCT  
Integrated dimmable driver  
Install in standard electrical junction box  
5-year warranty

---

**Finish**

- **BK** Black
- **WH** White

---

**Note**

Other color temperatures, finishes, and voltage options are available but may require minimum order quantities (MOQs) and longer lead times. Please contact your DALs representative for more information.

# ASCEND

This flat panel step light, designed for both indoor and outdoor use, combines modern elegance with robust functionality, casting a subtle and inviting glow to enhance safety and aesthetics in any space.



COLOR TEMPERATURE



WET



LEDSTEP005D-CC



Model	Size	Watts	Delivered lumens	CRI	Color °T	Voltage
LSTP07-CC	4-3/4"	4 W	150 lm	90	2200, 2700, 3000, 3500, 4000 K	120 V

### LSTP07-CC

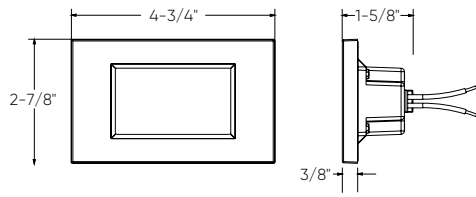

### Specifications

Die-cast aluminum housing  
Switch-selectable CCT  
Integrated dimmable driver  
Install in standard electrical junction box  
5-year warranty

### Finish









- **BK** Black
- **WH** White

### Note

Other color temperatures, finishes, and voltage options are available but may require minimum order quantities (MOQs) and longer lead times. Please contact your DALI representative for more information.

# ACCESSORIES

## FORMS GENERAL ACCESSORIES

		Model	Finish	Specifications
<b>LENS COVER</b> 		LNACC-L16FT	White	<ul style="list-style-type: none"> <li>• 16-foot lens for Boulevard series pendants, flush mounts and recessed linears</li> </ul>
<b>GLASS DOME</b> 		GL-CFG13	-	<ul style="list-style-type: none"> <li>• Frosted glass dome replacement for CFG13-CC flush mount</li> </ul>
<b>CHARACTER SET</b> 	<p>0123456789            0123456789            0123456789            0123456789            0123456789            -ABCDEFGHIJ            KLMNOPQR            STUVWXYZ</p>	SQS06-NUM-BK SQS10-NUM-BK SQS15-NUM-BK	Black	<ul style="list-style-type: none"> <li>• Adhesive Set: Includes 50 numbers and 27 characters, specifically designed for the SQS series wall sconces.</li> <li>• SQS06-NUM-BK: Size per letter: 3 cm</li> <li>• SQS10NUM-BK: Size per letter: 5 cm</li> <li>• SQS15-NUM-BK: Size per letter: 7cm</li> </ul>
<b>LENS REPLACEMENT</b> 		CAPD-ACCLL CAPD-ACCLS		<ul style="list-style-type: none"> <li>• Kit of 4 long lenses for CAPD72-CC 4-light pendant</li> <li>• Kit of 4 short lenses for CAPD72-CC 4-light pendant</li> </ul>
<b>INTERNAL TRIM</b> 		CYL05-TRIM-XX CYL06-TRIM-XX		<ul style="list-style-type: none"> <li>• 5" internal trim for CYL05-CC flush-mount cylinders, available in Alzac, Black, Gold, and White</li> <li>• 6" internal trim for CYL05-CC flush-mount cylinders, available in Alzac, Black, Gold, and White</li> </ul>











LANDSCAPE

LANDSCAPE 247 - 273

12 V



247  
CONNECTION  
GUIDE



250  
GLAM  
RTL-3C



252  
SLIM SPOT  
LSS10-CC



254  
SPOT  
LSP3-CCL  
LSP4-CCL



256  
SOL  
GRD2-CC



258  
EDGE  
LSQP-CC



260  
FLUX  
LPP20-CC



262  
COLUMN  
LRB20-CC  
LRB30-CC



264  
CONTOUR  
LHS07-CC



266  
TRANSFORMERS  
LTRP-60  
LTR-300

120 V



268  
STATURE  
LEDPATH004D

GENERAL



296  
ACCESSORIES

SMART LANDSCAPE 272 -297

24 V



272  
SMART CONNECTION  
GUIDE



276  
CORE  
DCP-TR60, DCP-TR200,  
DCP-TR300



278  
ORBIT  
DCP-SPT6



280  
GAÍA  
DCP-CPL24



282  
AXIS  
DCP-STK20  
DCP-STK50



284  
ACUTE  
DCP-45HP20



286  
HORIZON  
DCP-FLD30



288  
MASON  
DCP-BRK12



290  
FLEX  
DCP-NFTAP5M



292  
ORION  
DCP-STG48



294  
KAYU  
DCP-RK10  
DCP-RK18



297  
ACCESSORIES

How to create

# A low-voltage landscape lighting plan

## The three main components



### A. Low-voltage transformer

- The power supply for your system
- Usually mounted near or on the house that is plugged into a regular outdoor-rated **GFCI** electrical outlet.

*\*Avoid mounting the transformer in shady areas, this could interfere with the "dusk-to-dawn" photoelectric cell.*

*\*Should be installed at least 36" (3 feet) off the ground.*



### B. Landscape lighting fixtures

- Integrated LED spot lights, path lights, and bollards.
- Powered by the transformer

*\*When you choose lights, add up the total wattage they consume. You'll need this number for choosing other parts of your landscape lighting system.*



### C. Landscape lighting wire

- The wire connecting the transformer to the light fixtures.
- Rated according to the size of its conductor (gauge)

*\*A 12-gauge wire is larger and can handle more wattage than a 14-gauge wire.*

*\*Selecting the right wire size is important and will prevent any issues down the road.*

#### Transformers



60W

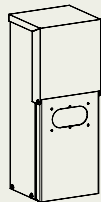

300W

#### Path lights

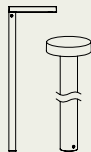

These fixtures aren't limited to paths. When mounted in gardens, they provide a gentle glow that lights a small surrounding area of plants, rock, or mulch.

#### Spot lights

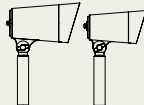

Use spotlights to make trees, plants, shrubbery, or a home's architectural features stand out.

#### Bollards



Use these lights to enhance the look of your yard while making walkways obvious at night.

#### Landscape wire



Versatile 12, 14, and 16 gauge low-voltage wire for spot lights, path lights, and bollards.

**GOOD**  
TO KNOW!

Mix it up! Different types of fixtures can be connected together.

## The four steps for an LED landscape installation



**Check your LED fixtures' voltage requirements. We strongly recommend verifying the voltage at each fixture with a voltmeter before finalizing and burying your installation.**

### 1. Map out a plan

- Start your layout by creating a sketch of your property.
- Be accurate with dimensions to help estimate distances for wire runs.
- Try sketching and measuring as you walk around the property marking where each fixture will be placed.

### 2. Set fixture locations

- Mark their locations with small flags on your property and indicate their placement on your sketch.
- Measure distances between fixtures and write them down on your layout.

### 3. Choose a power supply

- To figure out which power supply is best, consider two things: the total wattage of the lights that you're purchasing and if you anticipate adding lights in the future.
- When you add up the wattage of all lights, you'll have a good idea of how powerful your transformer needs to be. However, the total wattage of your lights should be 20 percent less than the transformer's rated wattage.
- Once you've selected the right transformer, the best placement is usually next to the house in a hidden location, as close as possible to the fixtures.

### Sample 12V Lighting Layout

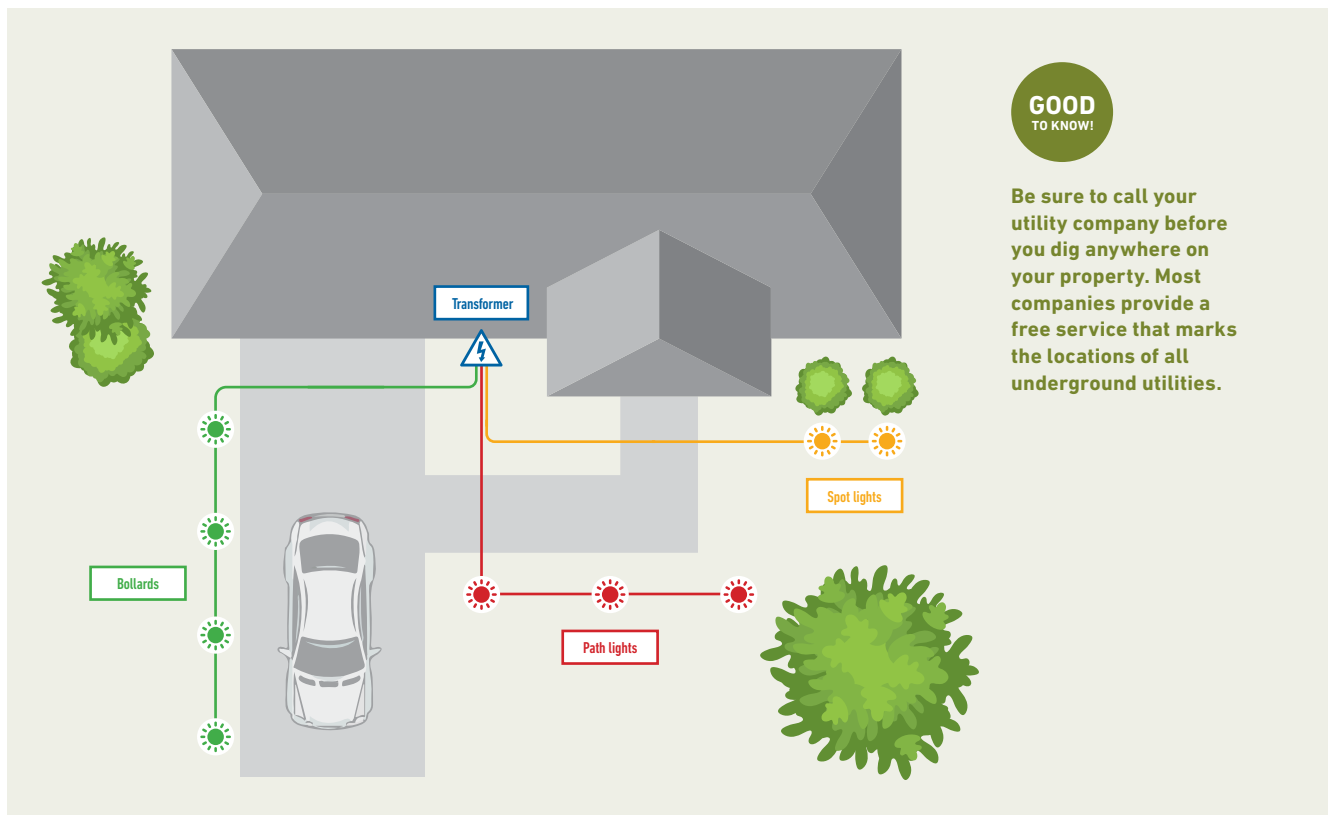



**Safe! Low-voltage lighting installations are much safer than 120V systems, with a significantly lower risk of electric shock and fire hazards.**

#### 4. Wiring

Now you need to provide power to the fixtures. The length of runs helps determine what gauge of wire to buy. As a general rule, try to keep the runs under 50 feet with a maximum of 8 fixtures per run. Lower loads per run means lower voltage drop.

#### What is Voltage Drop?

Voltage decreases as it moves through a run of wire and a series of lights. This means that, because each light is receiving a little less than the one before it, lights can appear dimmer toward the end of a series. A small loss is OK, but anything more than a 1.5-volt drop should be corrected.

**Minimize voltage drop and reduce wasted wire by using one of the wiring methods below:**

#### Daisy Chain (A)

Connects all fixtures in a linear fashion, where the first fixture connects to the transformer.

#### T-Method (B)

Similar to the Daisy Chain method, except the transformer connects to the middle of the chain

#### Hub Method (C)

All fixtures run through a hub junction and are connected to a single line from the transformer, ensuring each fixture receives an equal share of voltage

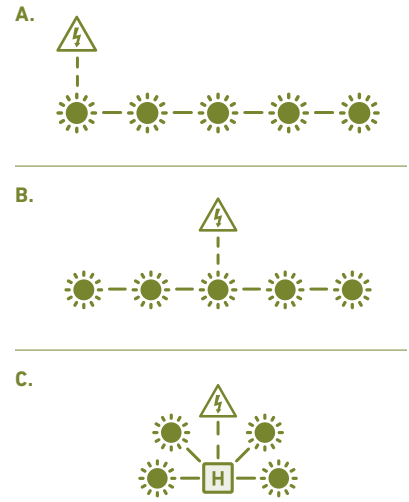

#### Sample 12V Wiring Diagram

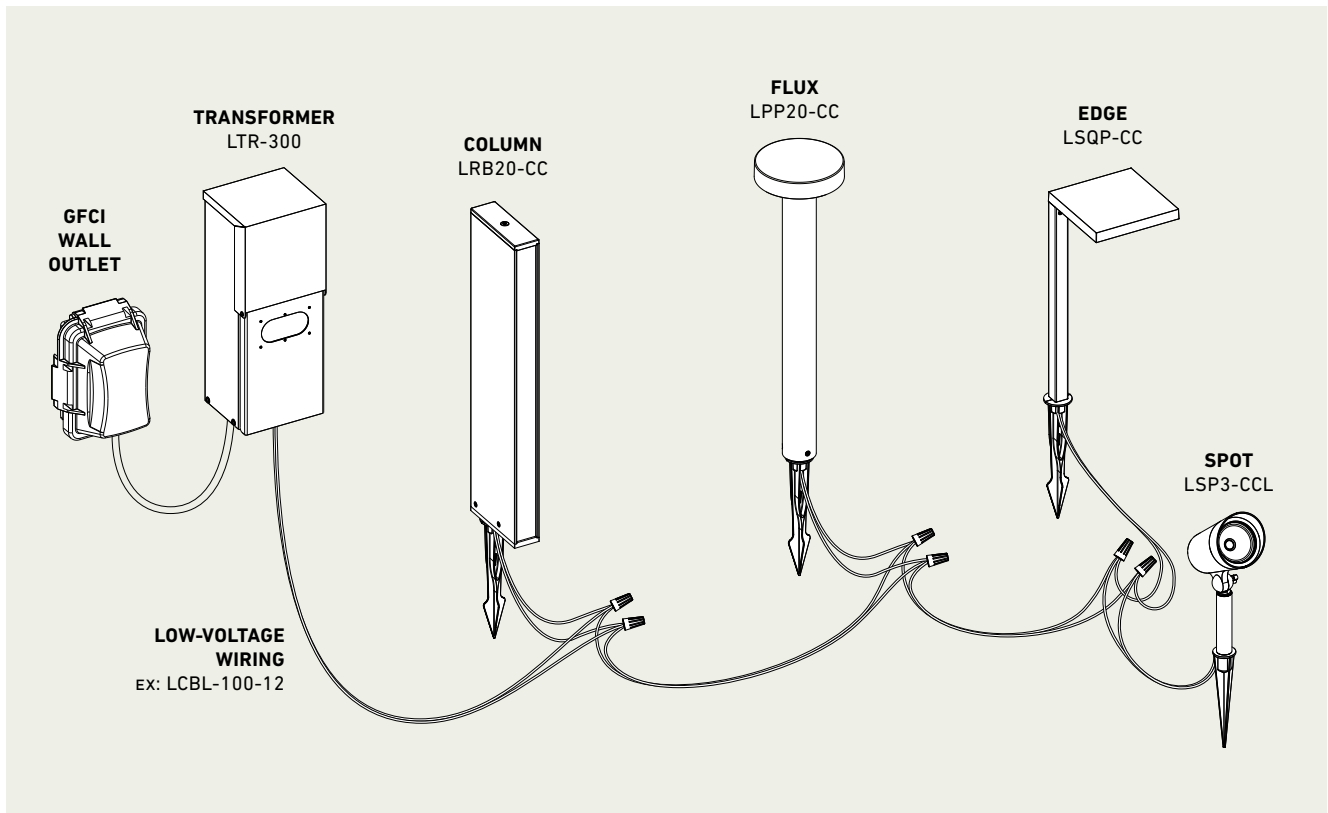

# GLAM

This rechargeable table lamp, featuring three color temperature settings and stepless dimming functionality, offers versatile lighting with a long-lasting 10-hour battery life.



RTL-3C



Model	Size	Watts	Delivered lumens	CRI	Color °T	Voltage
RTL-3C	14"	2 W	220 lm	80	2200, 2700, 3000 K	5 V





**RTL-3C**

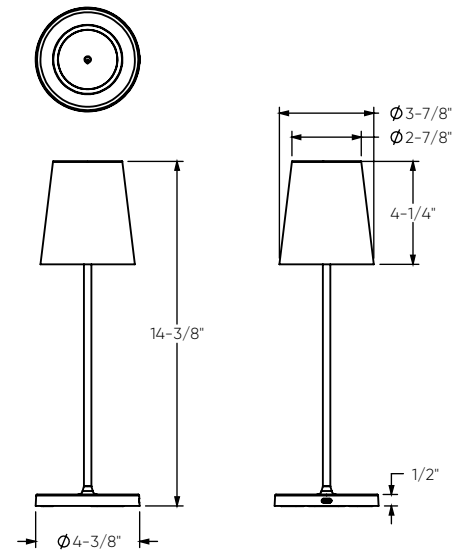

**Specifications**

- USB-C input/charge
- Button-selectable CCT
- 98° beam angle
- Smooth stepless dimming
- 5-year warranty

**Finish**

- **BK** Black
- **SA** Sage green
- **WH** White

**Note**

Other color temperatures and finish options are available but may require minimum order quantities (MOQs) and longer lead times. Please contact your DALIS representative for more information.

# SLIM SPOT

Illuminate your outdoor landscape with precision using this 12V spotlight, featuring a narrow 10° beam angle for focused and impactful lighting.

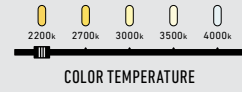

Model	Size	Watts	Delivered lumens	CRI	Color °T	Voltage
LSS10-CC	5-1/2"	10 W	370 lm	80	2200, 2700, 3000, 3500, 4000 K	12 VAC

## LSS10-CC

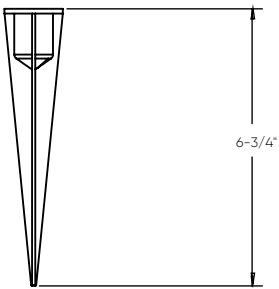
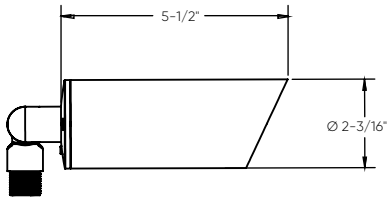
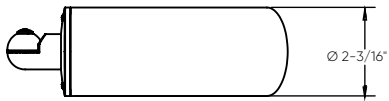

### Specifications

180° swiveling head  
Ground stake included  
10° beam angle  
Switch-selectable CCT  
5-year warranty

### Note

Low-voltage transformer required.  
Sold separately.

Other color temperatures and finish options are available but may require minimum order quantities (MOQs) and longer lead times. Please contact your DALs representative for more information.

### Finish

● **BK** Black

### Power supplies

#### LTRP-60-BK

60W, 120VAC 60Hz input  
12VAC output low-voltage transformer

#### LTR-300-BK

300W, 120VAC 60Hz input  
12/13/14/15VAC output low-voltage transformer

### Accessories

#### LAN-ACC-MS

6-3/4" metal ground stake

#### LSP-EXT04

4" extension arm

#### LSP-WM

Spotlight wall mount adapters

#### LCBL-50-16

50 feet of 16 gauge low-voltage wiring

#### LCBL-100-16

100 feet of 16 gauge low-voltage wiring

#### LCBL-50-14

50 feet of 14 gauge low-voltage wiring

#### LCBL-100-14

100 feet of 14 gauge low-voltage wiring

#### LCBL-100-12

100 feet of 12 gauge low-voltage wiring

#### LCBL-200-12

200 feet of 12 gauge low-voltage wiring

# SPOT

This durable, fully sealed 12V LED landscape spot is constructed of solid aluminum. It includes an integrated LED module that emits a cool, natural, or warm white light in multiple beam patterns, all selectable with a 5CCT switch. Can be rotated 180° and equipped with a glare shield for pinpoint accuracy. The landscape spotlight is great for gardens, tree uplighting, architectural lighting, and more.



LSPX-CCL



COLOR TEMPERATURE



WET



SWIVEL/DIRECTIONAL



Model	Size	Watts	Delivered lumens	CRI	Color °T	Voltage
LSP3-CCL	3"	10 W	500 lm	80	2200, 2700, 3000,	12 VAC
LSP4-CCL	4"	20 W	1000 lm		3500, 4000 K	



**LSP3-CCL**

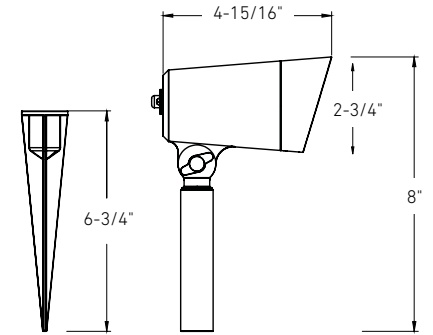

**LSP4-CCL**

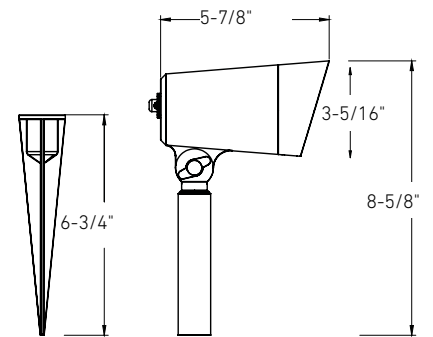

**Specifications**

- Switch-selectable CCT
- Easy-access CCT switch on back of spot
- Interchangeable 20°, 40°, and 90° beam angle lens
- 180° swiveling head
- Ground stake included
- 5-year warranty

**Finish**

- **BK** Black

**Power supplies**

**LTRP-60-BK**  
60W, 120VAC 60Hz input  
12VAC output low-voltage transformer

**LTR-300-BK**  
300W, 120VAC 60Hz input  
12/13/14/15VAC output low-voltage transformer

**Note**

Low-voltage transformer required. Sold separately.  
Other color temperatures and finish options are available but may require minimum order quantities (MOQs) and longer lead times. Please contact your DALI representative for more information.

**Accessories**

- LAN-ACC-MS**  
6-3/4" metal ground stake
- LSP-EXT04**  
4" extension arm
- LSP-WM**  
Spotlight wall mount adapters
- LCBL-50-16**  
50 feet of 16 gauge low-voltage wiring
- LCBL-100-16**  
100 feet of 16 gauge low-voltage wiring
- LCBL-50-14**  
50 feet of 14 gauge low-voltage wiring
- LCBL-100-14**  
100 feet of 14 gauge low-voltage wiring
- LCBL-100-12**  
100 feet of 12 gauge low-voltage wiring
- LCBL-200-12**  
200 feet of 12 gauge low-voltage wiring

# SOL

This durable, fully sealed 12V LED recessed ground light features an integrated LED module that provides cool, natural, or warm white light, all adjustable via a 5CCT switch. It is ideal for uplighting, wall washing, pathways, garden accents, and architectural highlights.

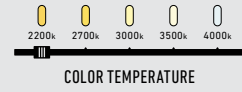

**IP67**  
RATED



Model	Size	Watts	Delivered lumens	CRI	Color °T	Voltage
GRD2-CC	2"	9 W	600 lm	80	2200, 2700, 3000, 3500, 4000 K	12 VAC





**GRD2-CC**

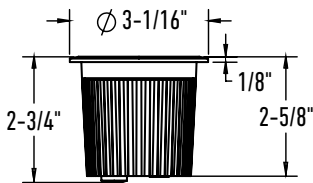

**Specifications**

Switch-selectable CCT  
 IP67-rated products are dustproof and can withstand immersion in water up to 1 meter for 30 minutes  
 Can be recessed or surface mounted  
 Includes a mounting housing  
 30° beam angle  
 5-year warranty

**Finish**

● **BK** Black

**Power supplies**

**LTRP-60-BK**  
 60W, 120VAC 60Hz input  
 12VAC output low-voltage transformer

**LTR-300-BK**  
 300W, 120VAC 60Hz input  
 12/13/14/15VAC output low-voltage transformer

**Note**

Low-voltage transformer required.  
 Sold separately.  
 Other color temperatures and finish options are available but may require minimum order quantities (MOQs) and longer lead times. Please contact your DALs representative for more information.

**Accessories**

**LCBL-50-16**  
 50 feet of 16 gauge low-voltage wiring

**LCBL-100-16**  
 100 feet of 16 gauge low-voltage wiring

**LCBL-50-14**  
 50 feet of 14 gauge low-voltage wiring

**LCBL-100-14**  
 100 feet of 14 gauge low-voltage wiring

**LCBL-100-12**  
 100 feet of 12 gauge low-voltage wiring

**LCBL-200-12**  
 200 feet of 12 gauge low-voltage wiring

# EDGE

A symmetrical luminaire made of rust-resistant aluminum and finished in a matte textured paint. Perfect for walkways, garden beds, or simply to direct the eye to some of your home's best features. Equipped with color-select technology that allows you to cast a particular color of light.

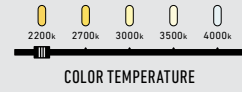

Model	Size	Watts	Delivered lumens	CRI	Color °T	Voltage
LSQP-CC	12"	3 W	265 lm	80	2200, 2700, 3000, 3500, 4000 K	12 VAC



## LSQP-CC

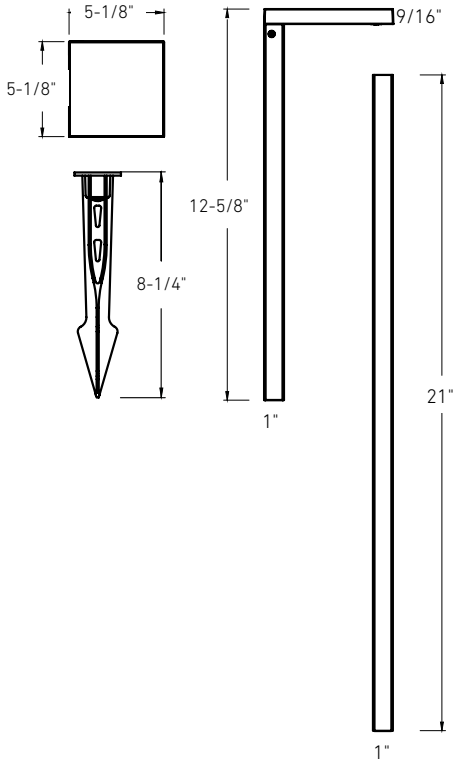

### Specifications

Ground stake included  
90° beam angle  
Switch-selectable CCT  
21" extension tube included  
5-year warranty

### Note

Low-voltage transformer required.  
Sold separately.  
Other color temperatures and finish options are available but may require minimum order quantities (MOQs) and longer lead times. Please contact your DALs representative for more information.

### Finish

● **BK** Black

### Power supplies

**LTRP-60-BK**  
60W, 120VAC 60Hz input  
12VAC output low-voltage transformer

**LTR-300-BK**  
300W, 120VAC 60Hz input  
12/13/14/15VAC output low-voltage transformer

### Accessories

**LCBL-50-16**  
50 feet of 16 gauge low-voltage wiring

**LCBL-100-16**  
100 feet of 16 gauge low-voltage wiring

**LCBL-50-14**  
50 feet of 14 gauge low-voltage wiring

**LCBL-100-14**  
100 feet of 14 gauge low-voltage wiring

**LCBL-100-12**  
100 feet of 12 gauge low-voltage wiring

**LCBL-200-12**  
200 feet of 12 gauge low-voltage wiring

# FLUX

Add visual interest to your garden with the Flux outdoor path light. A 360° light spread and cast aluminum construction with a powder-coated finish fits best along pathways, garden beds, and walkways.

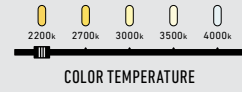

Model	Size	Watts	Delivered lumens	CRI	Color °T	Voltage
LPP20-CC	20"	8 W	360 lm	80	2200, 2700, 3000, 3500, 4000 K	12 VAC



## LPP20-CC

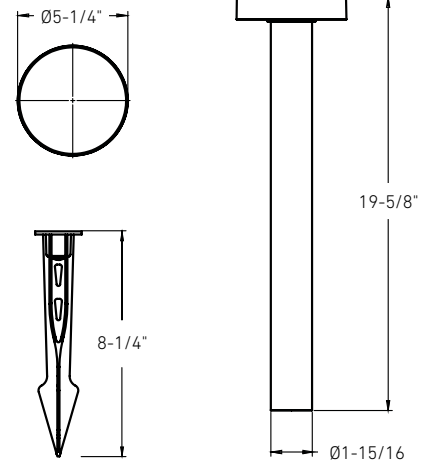

### Specifications

Ground stake included  
 93° beam angle  
 Can be mounted to wood or concrete (screws not included)  
 Switch-selectable CCT  
 5-year warranty

### Note

Low-voltage transformer required.  
 Sold separately.  
 Other color temperatures and finish options are available but may require minimum order quantities (MOQs) and longer lead times. Please contact your DALI representative for more information.

### Finish

● **BK** Black

### Power supplies

**LTRP-60-BK**  
 60W, 120VAC 60Hz input  
 12VAC output low-voltage transformer

**LTR-300-BK**  
 300W, 120VAC 60Hz input  
 12/13/14/15VAC output low-voltage transformer

### Accessories

**LCBL-50-16**  
 50 feet of 16 gauge low-voltage wiring

**LCBL-100-16**  
 100 feet of 16 gauge low-voltage wiring

**LCBL-50-14**  
 50 feet of 14 gauge low-voltage wiring

**LCBL-100-14**  
 100 feet of 14 gauge low-voltage wiring

**LCBL-100-12**  
 100 feet of 12 gauge low-voltage wiring

**LCBL-200-12**  
 200 feet of 12 gauge low-voltage wiring

# COLUMN

The Column series, a robust rectangular bollard that features a minimalist design for the ultimate in urban sophistication. Constructed of solid aluminum, it provides a chic solution to eco-conscious homeowners.

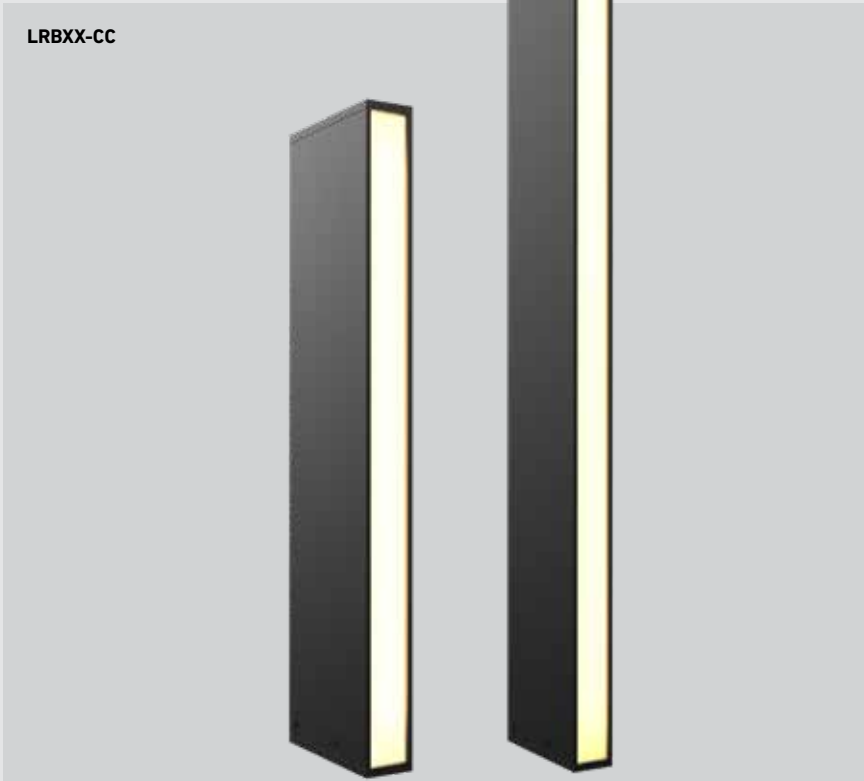
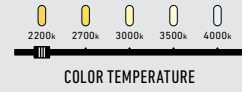

Model	Size	Watts	Delivered lumens	CRI	Color °T	Voltage
LRB20-CC	20"	12 W	600 lm	80	2200, 2700, 3000,	12 VAC
LRB30-CC	30"	13 W	700 lm		3500, 4000 K	

### LRB20-CC

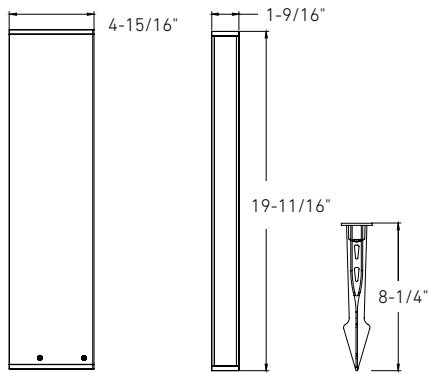

### LRB30-CC

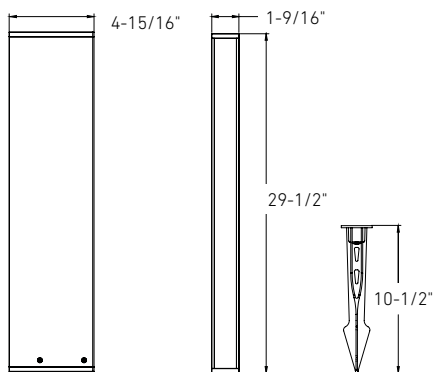

### Specifications

Ground stake included  
108° beam angle  
Can be mounted to wood or concrete using the included mounting bracket (screws not included)  
Switch-selectable CCT  
5-year warranty

### Finish

● **BK** Black

### Power supplies

**LTRP-60-BK**  
60W, 120VAC 60Hz input  
12VAC output low-voltage transformer

**LTR-300-BK**  
300W, 120VAC 60Hz input  
12/13/14/15VAC output low-voltage transformer

### Note

Low-voltage transformer required. Sold separately.  
Other color temperatures and finish options are available but may require minimum order quantities (MOQs) and longer lead times. Please contact your DALI representative for more information.

### Accessories

**LCBL-50-16**  
50 feet of 16 gauge low-voltage wiring

**LCBL-100-16**  
100 feet of 16 gauge low-voltage wiring

**LCBL-50-14**  
50 feet of 14 gauge low-voltage wiring

**LCBL-100-14**  
100 feet of 14 gauge low-voltage wiring

**LCBL-100-12**  
100 feet of 12 gauge low-voltage wiring

**LCBL-200-12**  
200 feet of 12 gauge low-voltage wiring

# CONTOUR

The Contour's compact size ensures a discreet and unobtrusive appearance while providing ample illumination for small to medium-sized areas. Its sleek and modern design seamlessly integrates into hardscape elements such as walls, steps, and patios. Crafted with high-quality materials, this fixture is built to withstand the elements, ensuring long-lasting durability and performance.

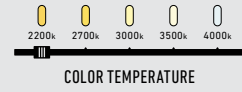

Model	Size	Watts	Delivered lumens	CRI	Color °T	Voltage
LHS07-CC	7"	3 W	200 lm	80	2200, 2700, 3000, 3500, 4000 K	12 VAC





## LHS07-CC

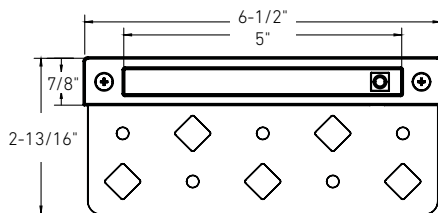

### Specifications

- 110° beam angle
- Can be mounted to wood or concrete
- Surface or recessed installation
- Switch-selectable CCT
- 5-year warranty

### Finish

- **BK** Black

### Power supplies

- LTRP-60-BK**  
60W, 120VAC 60Hz input  
12VAC output low-voltage transformer
- LTR-300-BK**  
300W, 120VAC 60Hz input  
12/13/14/15VAC output low-voltage transformer

### Note

Low-voltage transformer required.  
Sold separately.  
Other color temperatures and finish options are available but may require minimum order quantities (MOQs) and longer lead times. Please contact your DALI representative for more information.

### Accessories

- LCBL-50-16**  
50 feet of 16 gauge low-voltage wiring
- LCBL-100-16**  
100 feet of 16 gauge low-voltage wiring
- LCBL-50-14**  
50 feet of 14 gauge low-voltage wiring
- LCBL-100-14**  
100 feet of 14 gauge low-voltage wiring
- LCBL-100-12**  
100 feet of 12 gauge low-voltage wiring
- LCBL-200-12**  
200 feet of 12 gauge low-voltage wiring

# LOW-VOLTAGE TRANSFORMERS



Outdoor low-voltage transformers with timer and photocell sensor, 120V AC to 12V/13V/14V/15V AC, weatherproof.



LTR-300

LTRP-60



**Model**

**LTRP-60-BK**  
60W low-voltage transformer

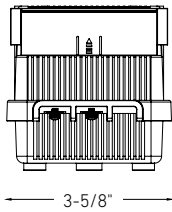
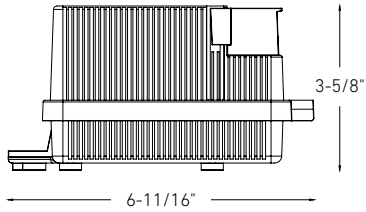

**Specifications**

Constant voltage mode power supply  
Protection: short circuit / Over voltage  
Input voltage: 120VAC 60Hz  
Output voltage: 12VAC  
Output Power: 60W  
Maximum recommended load: 80%  
Operating temperature: -30°C to 45°C  
UL certification  
5 year warranty

**Finish**

● **BK** Black

**Model**

**LTR-300-BK**  
300W low-voltage transformer

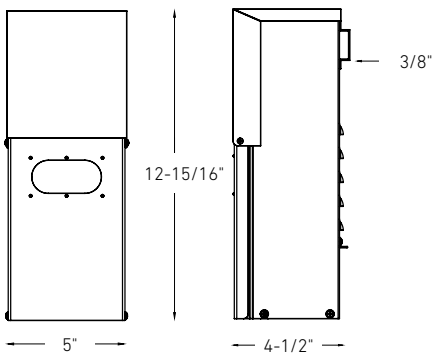

**Specifications**

Constant voltage mode power supply  
Protection: short circuit / Over voltage  
Fully isolated metal case -  
Cooling by air convection  
Input voltage: 120VAC 60Hz  
Output Power: 300W  
Output voltage: 12, 13, 14, 15VAC  
Photocell sensor  
Maximum recommended load: 80%  
Operating temperature: -30°C to 45°C  
UL certification  
5 year warranty

**Finish**

● **BK** Black

# STATURE

Add warm light to your outdoor landscape with this contemporary bollard. A modern statement, the Stature series features integrated LED's to ensure a long-lasting, energy-efficient, and maintenance-free illumination.

3000k

COLOR TEMPERATURE



LEDPATH004D

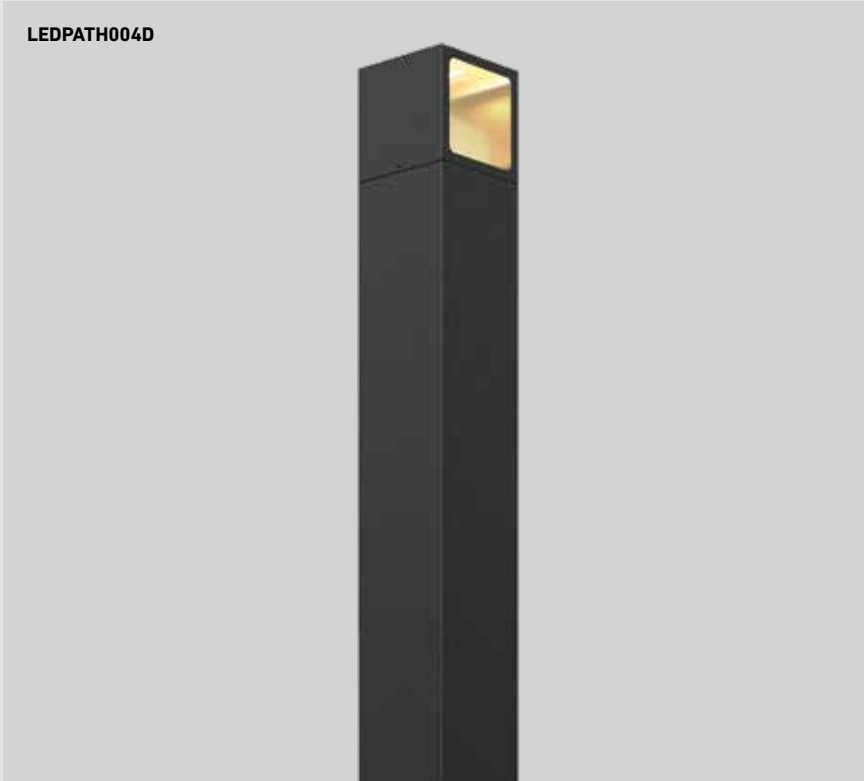

Model	Size	Watts	Delivered lumens	CRI	Color °T	Voltage
LEDPATH004D	36"	7.5 W	350 lm	90	3000 K	120 V



### Specifications

Integrated dimmable driver  
 Anchor bolts included  
 5-year warranty

### Finish

- **BK** Black
- **SG** Silver grey

### Note

Other color temperatures and finish options are available but may require minimum order quantities (MOQs) and longer lead times. Please contact your DALs representative for more information.

### LEDPATH004D

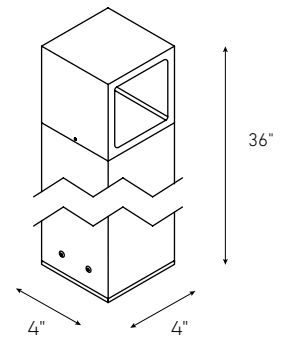







---

How to create

# A Dals Connect PRO Smart Landscape Plan



## The main components



### A. Low-voltage transformer

- The power supply for your system
- Usually mounted near or on the house that is plugged into a regular outdoor-rated gfcı electrical outlet.
- \* Avoid mounting the transformer in an area with poor Wi-Fi reception.
- \* Should be installed at least 36" (3 feet) off the ground.



### B. Landscape lighting fixtures

- Dals Connect PRO integrated LED spot lights, path lights, flood light, step light, stick light or ground light.
- Powered by the transformer
- \* When you choose lights, add up the total wattage they consume. You'll need this number for choosing the right transformer for your system.



Mix it up! Different types of Dals Connect PRO fixtures can be paired together with your smart landscape

#### Transformers

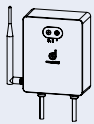

These 24V transformers come in three power capacities, 60W, 200W and 300W. An integrated PRO hub is also included.

#### Plug-in Transformer & Dals Connect PRO Hub

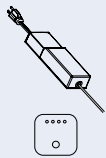

Use the 36W DC adapter paired with a PRO Hub for smaller landscape projects

#### Plug-in Transformer

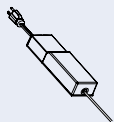

Use the 36W DC adapter paired without a hub for smaller landscape projects with local controls.

#### Path lights



These fixtures aren't limited to paths. When mounted in gardens, they provide a gentle glow that lights a small surrounding area of plants, rock, or mulch.

#### Spot lights

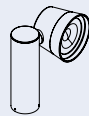

Use spotlights to make trees, plants, shrubbery, or a home's architectural features stand out.

#### Stick lights



Use these lights to enhance the look of your yard while making walkways obvious at night.

#### Step Light

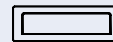

These fixtures can be surface-mounted to most surfaces, offering a soft glow that enhances visibility and style below.

#### Rock Light

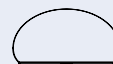

Add a touch of magic to your landscape with these glowing rock fixtures, blending seamlessly into natural surroundings while providing soft, ambient lighting.

#### Flood Light

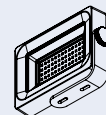

Use these lights to create wall washes or illuminate large areas of your yard.



**Check your LED fixtures' voltage requirements. We strongly recommend verifying the voltage at each fixture with a voltmeter before finalizing and burying your installation.**

## The science behind your SMART landscape

### 1. Map out a plan

- Start your layout by creating a sketch of your property.
- Be accurate with dimensions to help estimate distances for wire runs.
- Try sketching and measuring as you walk around the property marking where each fixture will be placed.
- You can also mark the spots on your land where the Wi-Fi signal drops on your phone, this will help determine the preferred spot for your transformer placement.

### 2. Set fixture locations

- Mark their locations with small flags on your property and indicate their placement on your sketch.
- Measure distances between fixtures and write them down on your layout.
- Note how far away your Wi-Fi signal can reach.
- Check that all smart landscape products are within 30 feet of each other for maximum connectivity.
- We recommend pairing your smart landscape lights closer to the house first, and then move them to their desired location. An Internet connection is required for the first pairing.

### 3. Choose a power supply

- To figure out which power supply is best, consider two things: the total wattage of the lights that you're purchasing and if you anticipate adding lights in the future.
- When you add up the wattage of all lights, you'll have a good idea of how powerful your transformer needs to be. The total wattage cannot exceed the capacity of the transformer.
- Once you've selected the right transformer, the best placement is usually next to the house in a hidden location, as close as possible to the first fixture and to your Wi-Fi.

### Sample 24V Smart Lighting Layout

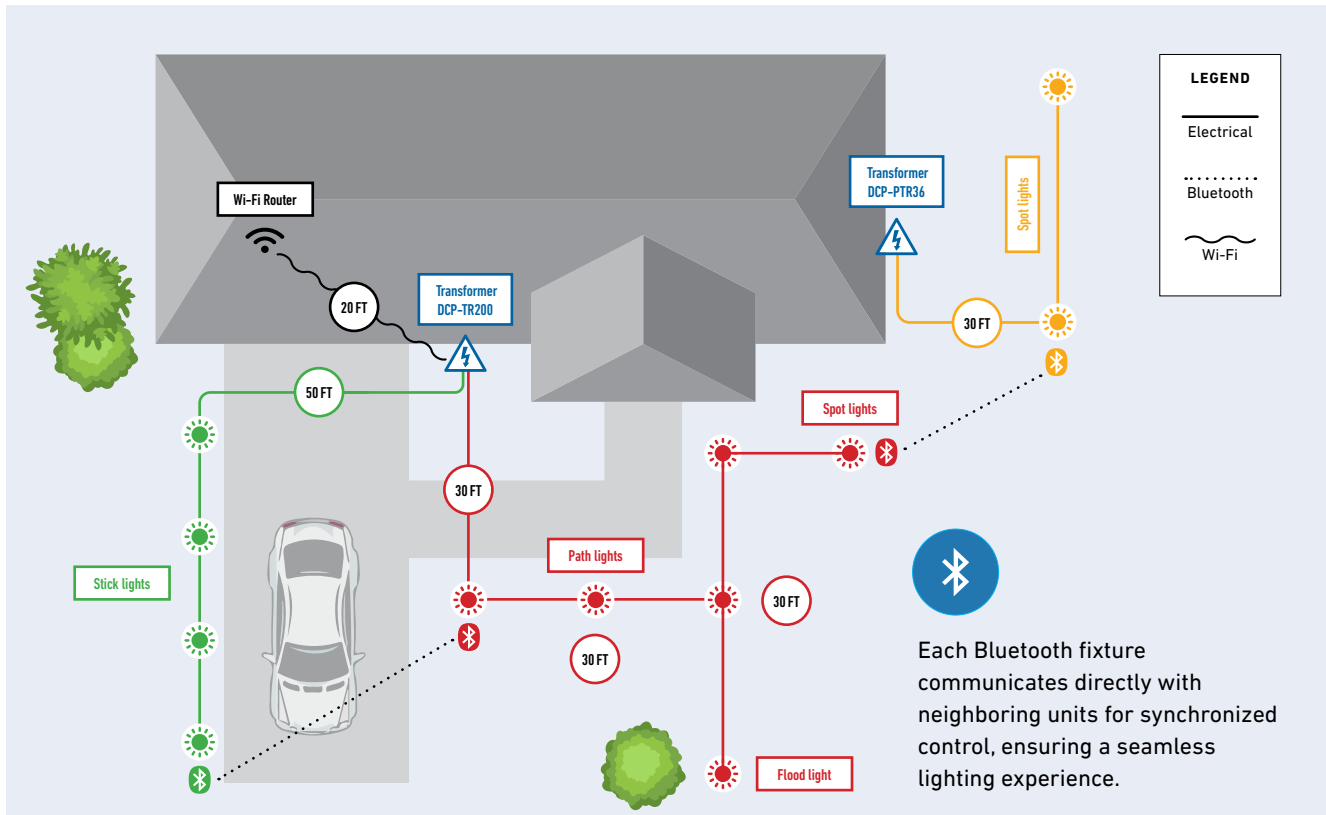





Be sure to call your utility company before you dig anywhere on your property. Most companies provide a free service that marks the locations of all underground utilities.

#### 4. Wiring

To set up Dals Connect PRO smart landscape products, use low-voltage wiring (not included) and secure connections with marettes for a customizable installation.

#### What is Voltage Drop?

Voltage decreases as it moves through a run of wire and a series of lights. This means that, because each light is receiving a little less than the one before it, lights can appear dimmer toward the end of a series. A small loss is OK, but anything more than a 2.5-volt drop should be corrected.

#### Checklist

Before you get ready to install your lights, make sure you have all the tools and accessories required. Below is a basic list of what you might need.

- Landscape lights
- Transformer
- Wire
- Tape measure
- Hardware for installing the transformer on a house or post
- Your Wi-Fi password

#### Sample 24V Smart Wiring Diagram

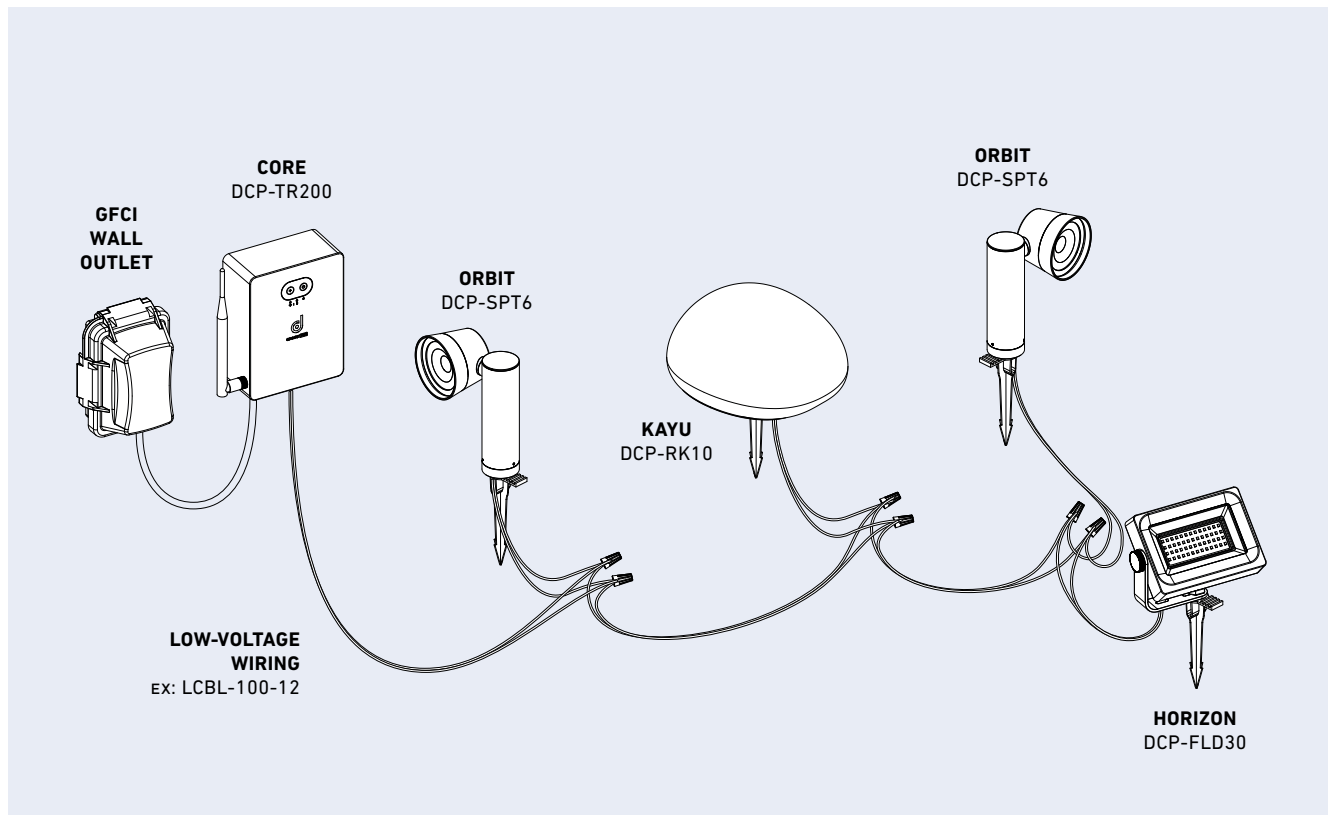

# CORE

The heart of your connected landscape system. By adding the Core, you unleash the full potential of smart lighting.



DCP-TR



## Model

### DCP-TR60

60W low-voltage smart transformer

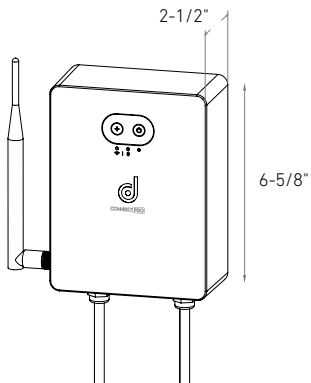

## Specifications

Constant voltage mode power supply

Protection: short circuit / Over voltage

Input voltage: 120VAC 60Hz

Output voltage: 24V DC

Output Power: 60W, 200W, and 300W

Maximum recommended load: 80%

Operating temperature: -30°C to 45°C

Control with the Dals Connect app

Integrated Hub

Number of supported smart devices per hub: 128

Can be controlled locally (without internet)

Works with Dals Connect PRO devices

Secure connection

Can be used with a voice-controlled assistant

Supports Wi-Fi and BLE Mesh protocols

5-year warranty

## Finish

● **BK** Black

### Download the Dals Connect app

Create groups

Set schedules

Remote access

Compatible with Google

Assistant and Amazon Alexa



### DCP-TR200

200W low-voltage smart transformer

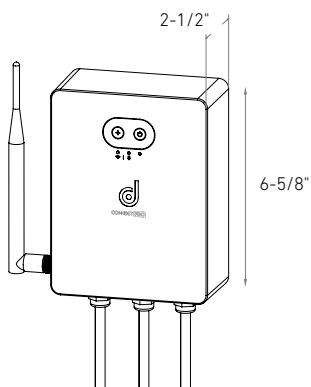

### DCP-TR300

300W low-voltage smart transformer

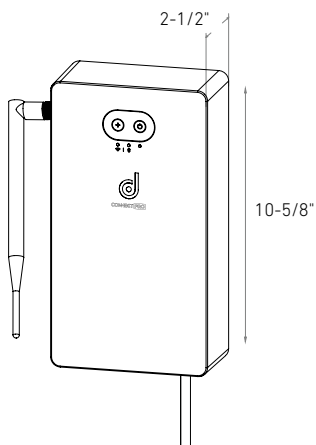

# ORBIT

A swiveling, low profile light designed to brighten a number of exterior applications. Ideal for walkways and flower beds but fits comfortably in any environment. Add a second or third fixture together and create a multi-head device.



DCP-SPT6



Model	Size	Watts	Delivered lumens	CRI	Color °T	Voltage
DCP-SPT6	6"	10 W	540 lm	90	RGB + 2200 K - 4000 K	24 V DC



## DCP-SPT6

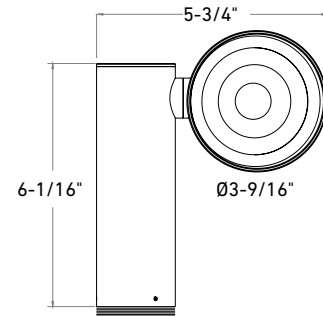
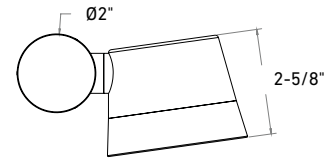

### Specifications

Full color spectrum  
 2200K - 4000K in pure whites  
 120° frosted lens included  
 40° beam angle  
 Up to three Orbit fixtures can be combined  
 Dimmable through the Dals Connect app and the Clicc remote (DCP-RMCT)  
 5-year warranty

### Note

Add the DALS Connect Pro Core transformer for even greater flexibility: voice control, remote access, expanded mesh network.

### Finish

● **BK** Black

### Smart transformers

**DCP-TR60-BK**  
 60W, 120VAC 60Hz input, 24V DC output low-voltage smart transformer

**DCP-TR200-BK**  
 200W, 120VAC 60Hz input, 24V DC output low-voltage smart transformer

**DCP-TR300-BK**  
 300W, 120VAC 60Hz input, 24V DC output low-voltage smart transformer

### Download the Dals Connect app

Create groups  
 Set schedules  
 Remote access\*  
 Compatible with Google Assistant and Amazon Alexa\*



\* Core needed

### Accessories

**DCP-RMCT**  
 Smart remote

**DCP-PTR36**  
 Plug-in driver

**DCP-ACC-MS12**  
 12" metal ground stake

**DCP-ACC-MS06**  
 6" metal ground stake

**DCP-ACC-MB**  
 Mounting bracket

**DCP-SPTTEXT14**  
 14" extension tube

**LCBL-50-16, LCBL-100-16**  
 50 or 100 feet of 16-gauge low-voltage wiring

**LCBL-50-14, LCBL-100-14**  
 50 or 100 feet of 14-gauge low-voltage wiring

**LCBL-100-12, LCBL-200-12**  
 100 or 200 feet of 12-gauge low-voltage wiring

# GAÏA

The main quality of this modern classic is providing downward, wide-area lighting that is both calming and practical. The luminaire includes a head that not only creates unique highlights in flower beds and neatly groomed lawns but can easily light up walkways and winding paths.



Model	Size	Watts	Delivered lumens	CRI	Color °T	Voltage
DCP-CPL24	24"	6 W	470 lm	80	RGB + 2200 K - 4000 K	24 V DC





## DCP-CPL24

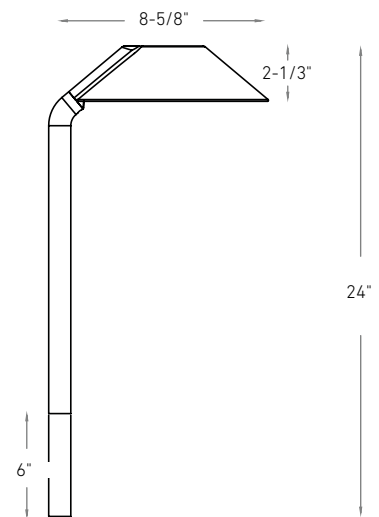

### Specifications

Full color spectrum  
 2200K - 4000K in pure whites  
 Adjustable height: 18" or 24"  
 120° beam angle  
 Dimmable through the Dals Connect app and the Clicc remote (DCP-RMCT)  
 5-year warranty

### Note

Add the DALS Connect Pro Core transformer for even greater flexibility: voice control, remote access, expanded mesh network.

### Finish

● **BK** Black

### Smart transformers

**DCP-TR60-BK**  
 60W, 120VAC 60Hz input, 24V DC output low-voltage smart transformer

**DCP-TR200-BK**  
 200W, 120VAC 60Hz input, 24V DC output low-voltage smart transformer

**DCP-TR300-BK**  
 300W, 120VAC 60Hz input, 24V DC output low-voltage smart transformer

### Download the Dals Connect app

Create groups  
 Set schedules  
 Remote access\*  
 Compatible with Google Assistant and Amazon Alexa\*



\* Core needed

### Accessories

**DCP-RMCT**  
 Smart remote

**DCP-PTR36**  
 Plug-in driver

**DCP-ACC-MS12**  
 12" metal ground stake

**DCP-ACC-MS06**  
 6" metal ground stake

**LCBL-50-16, LCBL-100-16**  
 50 or 100 feet of 16-gauge low-voltage wiring

**LCBL-50-14, LCBL-100-14**  
 50 or 100 feet of 14-gauge low-voltage wiring

**LCBL-100-12, LCBL-200-12**  
 100 or 200 feet of 12-gauge low-voltage wiring

# AXIS

A slender form and a soft black finish give this luminaire a contemporary style that fits almost anywhere.



Model	Size	Watts	Delivered lumens	CRI	Color °T	Voltage
DCP-STK20	20"	6 W	310 lm	80	RGB + 2200 K - 4000 K	24 V DC
DCP-STK50	50"	12 W	565 lm			



## DCP-STK20 / DCP-STK50

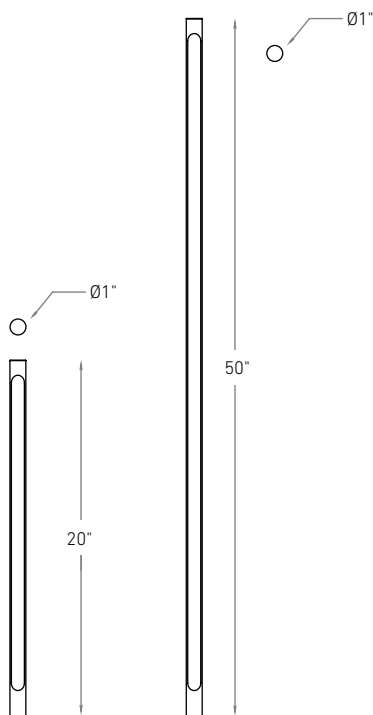

### Specifications

Full color spectrum  
2200K - 4000K in pure whites  
120° beam angle  
Dimmable through the Dals Connect app and the Clicc remote (DCP-RMCT)  
5-year warranty

### Note

Add the DALs Connect Pro Core transformer for even greater flexibility: voice control, remote access, expanded mesh network.

### Finish

● **BK** Black

### Smart transformers

#### DCP-TR60-BK

60W, 120VAC 60Hz input, 24V DC output low-voltage smart transformer

#### DCP-TR200-BK

200W, 120VAC 60Hz input, 24V DC output low-voltage smart transformer

#### DCP-TR300-BK

300W, 120VAC 60Hz input, 24V DC output low-voltage smart transformer

### Download the Dals Connect app

Create groups  
Set schedules  
Remote access\*  
Compatible with Google Assistant and Amazon Alexa\*



\*Core needed

### Accessories

#### DCP-RMCT

Smart remote

#### DCP-PTR36

Plug-in driver

#### DCP-ACC-MS12

12" metal ground stake

#### DCP-ACC-MS06

6" metal ground stake

#### DCP-ACC-MB

Mounting bracket

#### LCBL-50-16, LCBL-100-16

50 or 100 feet of 16-gauge low-voltage wiring

#### LCBL-50-14, LCBL-100-14

50 or 100 feet of 14-gauge low-voltage wiring

#### LCBL-100-12, LCBL-200-12

100 or 200 feet of 12-gauge low-voltage wiring

# ACUTE

With its 45-degree angled head, this modern classic provides calming and practical downward lighting, casting unique highlights in gardens and effortlessly illuminating pathways.



CHANGE COLORS



Model	Size	Watts	Delivered lumens	CRI	Color °T	Voltage
DCP-45HP20	20"	7 W	600 lm	80	RGB + 2200 K - 4000 K	24 V DC

## DCP-45HP20

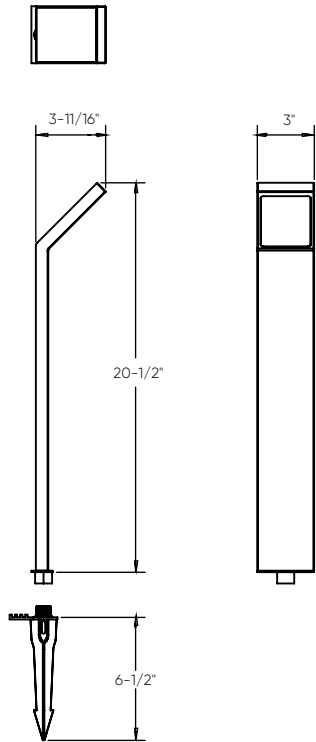

### Specifications

Full color spectrum  
2200K - 4000K in pure whites  
45° beam angle  
Dimmable through the Dals Connect app and the Clicc remote (DCP-RMCT)  
5-year warranty

### Note

Add the DALS Connect Pro Core transformer for even greater flexibility: voice control, remote access, expanded mesh network.

### Finish

● **BK** Black

### Smart transformers

**DCP-TR60-BK**  
60W, 120VAC 60Hz input, 24V DC output low-voltage smart transformer

**DCP-TR200-BK**  
200W, 120VAC 60Hz input, 24V DC output low-voltage smart transformer

**DCP-TR300-BK**  
300W, 120VAC 60Hz input, 24V DC output low-voltage smart transformer

### Download the Dals Connect app

Create groups  
Set schedules  
Remote access\*  
Compatible with Google Assistant and Amazon Alexa\*



\* Core needed

### Accessories

**DCP-RMCT**  
Smart remote

**DCP-PTR36**  
Plug-in driver

**DCP-ACC-MS12**  
12" metal ground stake

**DCP-ACC-MS06**  
6" metal ground stake

**LCBL-50-16, LCBL-100-16**  
50 or 100 feet of 16-gauge low-voltage wiring

**LCBL-50-14, LCBL-100-14**  
50 or 100 feet of 14-gauge low-voltage wiring

**LCBL-100-12, LCBL-200-12**  
100 or 200 feet of 12-gauge low-voltage wiring

# HORIZON

Made of high strength aluminum alloy with adjustable precision. Incredibly bright with a 120° degree beam angle, it can be wall mounted or staked in the ground.



Model	Size	Watts	Delivered lumens	CRI	Color °T	Voltage
DCP-FLD30	7"	30 W	3000 lm	80	RGB + 2200 K - 4000 K	24 V DC

## DCP-FLD30

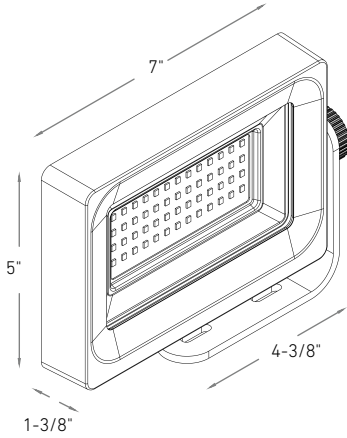

### Specifications

Full color spectrum  
2200K - 4000K in pure whites  
Can be wall mounted  
120° beam angle  
Dimmable through the Dals Connect app and the Clicc remote (DCP-RMCT)  
5-year warranty

#### Note

Add the DALS Connect Pro Core transformer for even greater flexibility: voice control, remote access, expanded mesh network.

#### Finish

● **BK** Black

### Smart transformers

#### DCP-TR60-BK

60W, 120VAC 60Hz input, 24V DC output low-voltage smart transformer

#### DCP-TR200-BK

200W, 120VAC 60Hz input, 24V DC output low-voltage smart transformer

#### DCP-TR300-BK

300W, 120VAC 60Hz input, 24V DC output low-voltage smart transformer

#### Download the Dals Connect app

Create groups  
Set schedules  
Remote access\*  
Compatible with Google Assistant and Amazon Alexa\*



\* Core needed

### Accessories

#### DCP-RMCT

Smart remote

#### DCP-PTR36

Plug-in driver

#### DCP-ACC-MS12

12" metal ground stake

#### DCP-ACC-MS06

6" metal ground stake

#### DCP-ACC-MB

Mounting bracket

#### LCBL-50-16, LCBL-100-16

50 or 100 feet of 16-gauge low-voltage wiring

#### LCBL-50-14, LCBL-100-14

50 or 100 feet of 14-gauge low-voltage wiring

#### LCBL-100-12, LCBL-200-12

100 or 200 feet of 12-gauge low-voltage wiring

# MASON

With its minimalistic form, simple casing and subtle appearance, Mason fits seamlessly into the architecture of any home.



DCP-BRK12



Model	Size	Watts	Delivered lumens	CRI	Color °T	Voltage
DCP-BRK12	12"	8 W	280 lm	80	RGB + 2200 K - 4000 K	24 V DC



## DCP-BRK12

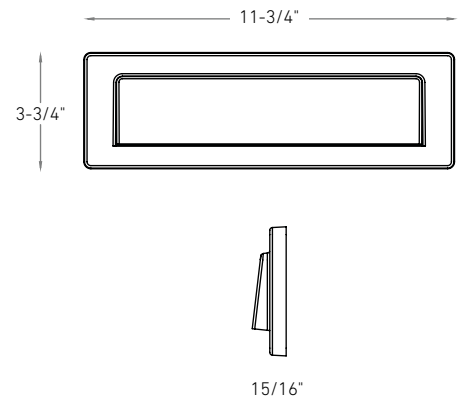

### Specifications

Full color spectrum  
 2200K - 4000K in pure whites  
 Can be recessed or surface mounted  
 40° beam angle  
 Dimmable through the Dals Connect app and the Clicc remote (DCP-RMCT)  
 Installs into a standard electrical junction box  
 5-year warranty

### Note

Add the DALS Connect Pro Core transformer for even greater flexibility: voice control, remote access, expanded mesh network.

### Finish

● **BK** Black

### Smart transformers

**DCP-TR60-BK**  
 60W, 120VAC 60Hz input, 24V DC output low-voltage smart transformer

**DCP-TR200-BK**  
 200W, 120VAC 60Hz input, 24V DC output low-voltage smart transformer

**DCP-TR300-BK**  
 300W, 120VAC 60Hz input, 24V DC output low-voltage smart transformer

### Download the Dals Connect app

Create groups  
 Set schedules  
 Remote access\*  
 Compatible with Google Assistant and Amazon Alexa\*



\* Core needed

### Accessories

**DCP-RMCT**  
 Smart remote

**DCP-PTR36**  
 Plug-in driver

**LCBL-50-16, LCBL-100-16**  
 50 or 100 feet of 16-gauge low-voltage wiring

**LCBL-50-14, LCBL-100-14**  
 50 or 100 feet of 14-gauge low-voltage wiring

**LCBL-100-12, LCBL-200-12**  
 100 or 200 feet of 12-gauge low-voltage wiring



# FLEX

Transform any space with ease using our 5-meter smart neon tape light, seamlessly blending vibrant colors and dynamic lighting effects to create an ambiance that suits your mood and style.



DCP-NFTAP5M

Model	Size	Watts	Delivered lumens	CRI	Color °T	Voltage
DCP-NFTAP5M	5m (196")	24 W	1200 lm	80	RGB + 2200 K- 4000 K	24 V DC





### Specifications

Full color spectrum  
 2200K - 4000K in pure whites  
 Seamless light emission with zero hotspots  
 Flexible and bendable laterally only  
 Can be cut every 2.5 inches  
 (cannot be reconnected)  
 36W plug-in transformer included  
 Includes a wired controller with smart  
 button for CCT selection, color customization  
 and on/off control  
 Dimmable through the Dals Connect app and  
 the Clicc remote (DCP-RMCT)  
 5-year warranty

### Note

Add the DALS Connect Pro Core transformer  
 or the Pro Hub for even greater flexibility:  
 voice control, remote access, expanded mesh  
 network.

### Finish

○ WH White

### Accessories

- DCP-RMCT**  
Smart remote
- DCP-ACC-NFEC**  
Silicone end cap for Neon Flex Tape
- DCP-ACC-NFCH**  
1 meter U-channel for Neon Flex Tape

### Download the Dals Connect app

Create groups  
 Set schedules  
 Remote access\*  
 Compatible with Google  
 Assistant and Amazon Alexa\*



\*Pro Core or the Pro Hub needed

### DCP-NFTAP5M

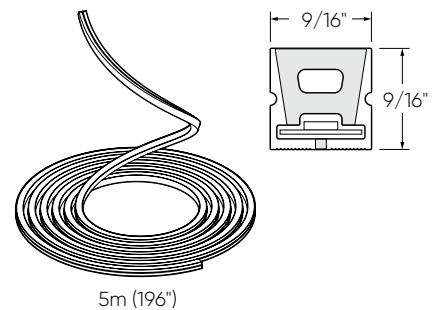

# ORION

Garden parties, birthdays or a relaxing dinner. Create the perfect atmosphere with the numerous lighting effects provided by the Orion string light.



Model	Size	Watts	Delivered lumens	CRI	Color °T	Voltage
DCP-STG48	48'	12 W	1200 lm	80	RGB + 2200 K - 4000 K	24 V DC



### Specifications

- Full color spectrum
- 2200K - 4000K in pure whites
- 24W plug-in driver included
- One 24W transformer can power two string lights daisy chained together
- 15 bulbs per string
- On-wire remote control
- Preset animations
- Dimmable through the Dals Connect app
- 5-year warranty

### Note

Add the DALS Connect Pro Core transformer or the Pro Hub for even greater flexibility: voice control, remote access, expanded mesh network.

### Finish

- **BK** Black

### Accessories

**DCP-STGACBLB**  
Bulb replacement

**DCP-STGACPCB**  
PCB replacement

### Download the Dals Connect app

- Create groups
- Set schedules
- Remote access\*
- Compatible with Google Assistant and Amazon Alexa\*



\*Pro Core or the Pro Hub needed

### DCP-STG48

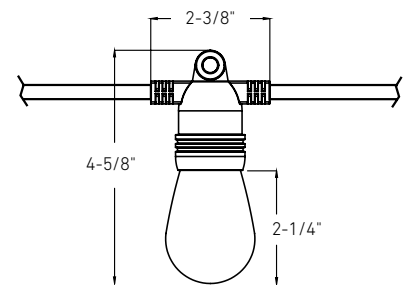

# KAYU

Sprinkle your landscape with subtle touches of light. The Kayu series, a harmonious and organic fixture easily creates a welcoming atmosphere.



Model	Size	Watts	Delivered lumens	CRI	Color °T	Voltage
DCP-RK10	10"	5 W	400 lm	80	RGB + 2200 K - 4000 K	24 V DC
DCP-RK18	18"	7 W	600 lm			



### DCP-RK10

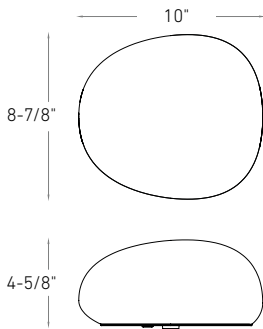

### DCP-RK18

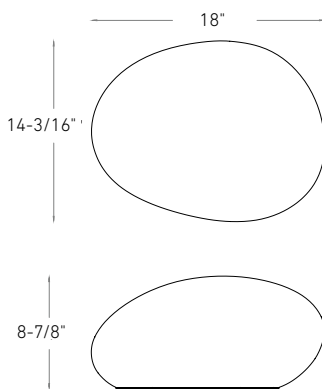

### Specifications

Full color spectrum  
2200K - 4000K in pure whites  
Dimmable through the Dals Connect app and the Clicc remote (DCP-RMCT)  
5-year warranty

### Note

Add the DALS Connect Pro Core transformer for even greater flexibility: voice control, remote access, expanded mesh network.

### Finish

**WH** White

### Smart transformers

#### DCP-TR60-BK

60W, 120VAC 60Hz input, 24V DC output low-voltage smart transformer

#### DCP-TR200-BK

200W, 120VAC 60Hz input, 24V DC output low-voltage smart transformer

#### DCP-TR300-BK

300W, 120VAC 60Hz input, 24V DC output low-voltage smart transformer

### Download the Dals Connect app

Create groups  
Set schedules  
Remote access\*  
Compatible with Google Assistant and Amazon Alexa\*



\* Core needed

### Accessories

#### DCP-RMCT

Smart remote

#### DCP-PTR36

Plug-in driver

#### DCP-ACC-MS12

12" metal ground stake

#### DCP-ACC-MS06

6" metal ground stake

#### LCBL-50-16, LCBL-100-16

50 or 100 feet of 16-gauge low-voltage wiring















#### LCBL-50-14, LCBL-100-14

50 or 100 feet of 14-gauge low-voltage wiring















#### LCBL-100-12, LCBL-200-12

100 or 200 feet of 12-gauge low-voltage wiring

# LANDSCAPE ACCESSORIES

Model		Finish	Specification
<b>LAN-ACC-MS</b>  WET		Black	• 6-3/4 in. metal replacement stake for spotlights
<b>LAN-ACC-PS</b>  WET		Black	• 7-1/4 in. plastic replacement stake for path lights and bollards
<b>LCBL-50-16</b> <b>LCBL-100-16</b> <b>LCBL-50-14</b> <b>LCBL-100-14</b> <b>LCBL-100-12</b> <b>LCBL-200-12</b>  WET		Black	• 16, 14, and 12 gauge low-voltage wire in 50, 100, and 200 ft. lengths.
<b>LSP-EXT04</b>  WET		Black	• 4 in. extension arm
<b>LSP-WM</b>  WET		Black	• Spotlight wall mount adapter
<b>LSP3-ACCLN</b> <b>LSP4-ACCLN</b>  WET		Clear	• 20° and 40° interchangeable lenses for LSP3-CC and LSP3-CC spot lights
<b>LSQP-ACC-PS</b>  WET		Black	• 7-1/4 in. plastic replacement stake for LSQP-CC path light

# SMART LANDSCAPE ACCESSORIES

Model		Finish	Specification
<b>DCP-ACC-MB</b>  WET		Black	<ul style="list-style-type: none"> <li>• Mounting bracket for smart landscape lights</li> </ul>
<b>DCP-ACC-MS06</b> <b>DCP-ACC-MS12</b>  WET		Black	<ul style="list-style-type: none"> <li>• 6 and 12 in. metal replacement ground stakes for smart landscape lights</li> </ul>
<b>LCBL-50-16</b> <b>LCBL-100-16</b> <b>LCBL-50-14</b> <b>LCBL-100-14</b> <b>LCBL-100-12</b> <b>LCBL-200-12</b>  WET		Black	<ul style="list-style-type: none"> <li>• 16, 14, and 12 gauge low-voltage wire in 50, 100, and 200 ft. lengths.</li> </ul>
<b>DCP-PTR36</b>  WET		Black	<ul style="list-style-type: none"> <li>• 36W plug-in driver for smart landscape lights</li> </ul>
<b>DCP-SPTACLENS</b>  WET		Frosted white	<ul style="list-style-type: none"> <li>• 120° frosted lens for DCP-SPT6 spot light</li> </ul>
<b>DCP-SPTTEXT14</b>  WET		Black	<ul style="list-style-type: none"> <li>• 14 in. extension tube for DCP-SPT6 spot light</li> </ul>
<b>DCP-STGACCLB</b> <b>DCP-STGACPCB</b>  WET		White	<ul style="list-style-type: none"> <li>• Replacement bulb for DCP-STG48 string light</li> <li>• Replacement PCB for DCP-STG48 string light</li> </ul>







SMART



**301**  
**CONNECTION**  
**GUIDE**



**304**  
**PRO HUB**  
DCP-HUB



**306**  
**PIVOT PRO**  
DCP-FGM4



**308**  
**REVOLVE PRO**  
DCP-GBR35



**310**  
**ETCH PRO**  
DCP-DDP4  
DCP-DDP6

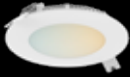

**312**  
**EXCEL PRO**  
DCP-PNL4  
DCP-PNL6

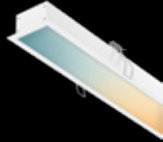

**314**  
**BOULEVARD PRO**  
DCP-LNR24  
DCP-LNR48

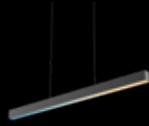

**316**  
**BOULEVARD**  
**PENDANT PRO**  
DCP-LNPD48



**318**  
**FRAME**  
DCP-CGWS



**320**  
**ARCHITECT**  
DCP-LWS19



**322**  
**GLOW**  
DCP-TAPXXFT



**324**  
**AXIS PRO**  
SM-STTL20  
SM-STFL50



**326**  
**A21 PRO**  
DCP-BLBA21



**328**  
**BR30 PRO**  
DCP-BLBBR30



**330**  
**CLICC**  
DCP-RMCT



**332**  
**SMART DIMMER SWITCH**  
SM-DIMSW



## One app — one smart ecosystem with technology options

DALS launched its first smart home products in 2017 and has sold over 350,000 devices as of December 2023, showcasing our developed application expertise.

In 2019, the introduction of our DALs Connect platform quickly established its leadership with its Wi-Fi direct product ecosystem.

In 2022, DALs expanded its offerings with the launch of the DALs Connect PRO product assortment.

This line utilizes Bluetooth mesh technology, enabling a higher number of devices on a network and introducing several other advanced features.

Both DALs Connect and DALs Connect PRO products seamlessly work together and can easily coexist on the same application.

## There are many benefits to smart lighting



### Experience

White color temperature and a wide array of fun colors are easily changeable, allowing you a multitude of lighting options for comfort.



### Save

Save on energy and increase your home's security by using schedules or remotely turning on/off the lights when no one is home.



### Control

Easily control your lighting with smart switches, your phone, or a voice assistant for even more convenience.



### Create

With the Dals Connect app, you can program your own lighting scenes for specific conditions and tasks, such as watching movies, daytime or nighttime reading, parties, and much more. Within a scene, you can change the brightness, color temperature, and even use different hues.

# What are the main differences between DALS Connect and DALS Connect PRO?



## dals **CONNECT**

### Quick start – direct features

DALS Connect products use Wi-Fi wireless technology which is used widely to connect computers, tablets, smartphones, smart devices, and others to the internet. Wi-Fi is shared through a router to all Wi-Fi enabled devices. This technology allows for a lot of range and a lot of devices, although there are some limitations as well. Wi-Fi has a relatively high absorption rate and works best for line-of-sight uses. A residential wireless access point usually has a range of about 30 feet and a maximum of 20 devices, depending on the type of wireless access point.



## dals **CONNECT PRO**

### Higher number of devices – independent network

DALS Connect PRO uses Bluetooth-mesh technology. It works on the principle that each Bluetooth device on the mesh network can relay commands to another device, through the connection from the previous device. Bluetooth-mesh networking is a standard based on Bluetooth Low Energy that allows for many-to-many communication over Bluetooth radio. You can use your smart phone or tablet to control large groups of products even without an internet connection.

### Dals Connect Pro hub

You can also add the Dals Connect Pro hub, to connect up to 128 DALS Connect PRO products to the cloud as a single internet connection (as opposed to DALS Connect products where each product has its individual connection). You can also use multiple hubs for projects with more than 200 devices, with each hub acting as an internet connection as well. Cloud connection allows you to use your products with voice command platforms (such as Google Home and Amazon Alexa) as well as allowing for remote control.



**Not all Wi-Fi routers are created equal.** A 30\$ router will not perform the same or support the same number of devices as a 350\$ router. The number of antennas will greatly increase your Wi-Fi range.



**Most smart devices only operate on the 2.4 GHz spectrum, whereas most routers nowadays share the same band for 5 GHz and 2.4 GHz.** If you experience issues with disconnecting devices or trouble adding new devices, try separating your 5 GHz and 2.4 GHz band on your router. Your internet service provider can help you set this up.

# Which one is best for me?

Thanks to the Dals Connect Application, you don't have to use multiple apps to control all of your smart devices, even if you decide to mix and match communication technologies.

The Dals Connect App can support Bluetooth-mesh devices mixed with Wi-Fi devices, and you can add cloud connectivity to your Bluetooth-mesh devices using the Dals Connect Pro hub. All of these will work together, but which one is right for you? Let's find out.

	DALS Connect	DALS Connect PRO	DALS Connect PRO + Hub
Uses the DALS Connect App	•	•	•
Can be controlled from multiple devices at once	•		•
Operating range within the controller's line of sight (Wi-Fi router or another Bluetooth-mesh device)	30 FT	50 FT	50 FT
Number of supported smart devices	20	100*	200
Can be controlled locally (without internet)		•	•
Requires multiple access points to extend the range	•		
Secure connection	•	•	•
Can be used with voice-controlled assistant	•		•

*\*The actual maximum number of Bluetooth devices supported in a mesh network is much higher (32 767) but achieving these numbers would require professional network installations and mesh network segmentation.*



**You can use a free network scanner tool to determine the limited range of your router.** Wireless strength is represented as dBm (decibel-milliwatts) and a good Wi-Fi signal will usually range between -30 and -65 dBm. Anything lower than -65 dBm will most likely experience issues.



**The technology you choose doesn't have to be all the same.** You can easily combine Bluetooth Mesh devices with Wi-Fi devices thanks to the Dals Connect App. It all depends on the application. If you wish to have smart recessed devices for your exterior soffits, you would opt for Dals Connect Pro products to gain maximum range and inter-connectivity, and could combine them with Wi-Fi products for your living room. The choice is up to you!

# PRO HUB

By connecting to the hub you enable communication with the cloud and the Dals Connect app, allowing users to easily view and control up to 200 smart devices for each hub that use the Bluetooth protocol. Supports Wi-Fi, Ethernet and BLE Mesh: You can control it remotely through Wi-Fi or Ethernet and locally through BLE, ensuring gateway availability even if there is no network.



DCP-HUB



Model	Size	Wi-Fi	Ethernet	Bluetooth	Number of supported devices	Alexa & Google Assistant compatible	Voltage
DCP-HUB	4"	√	√	√	200*	√	120 V

\*Per Hub



### Specifications

- Indoor use only
- Control with the Dals Connect app
- Number of supported smart devices per hub: 200
- Can be controlled locally (without internet)
- Can be powered through any USB port with power
- Works with Dals Connect PRO devices
- Secure connection
- Can be used with a voice-controlled assistant
- Supports Wi-Fi and BLE Mesh protocols
- Supports a hardwired internet connection using an ethernet cable
- 5-year warranty

### Finish

- WH** White

### Note

For remote access a secured 2.4 GHz wireless network or an ethernet cable (included) is required.

### Download the Dals Connect app



### DCP-HUB

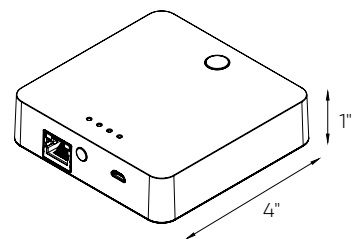



NEW

# PIVOT PRO

The Pivot Pro gimbal recessed light offers adjustable, app-controlled illumination, enhancing both convenience and atmosphere in any space.



WET



SWIVEL/DIRECTIONAL



CHANGE COLORS



AIR TIGHT



IC RATED



T24 JA8 CERTIFIED

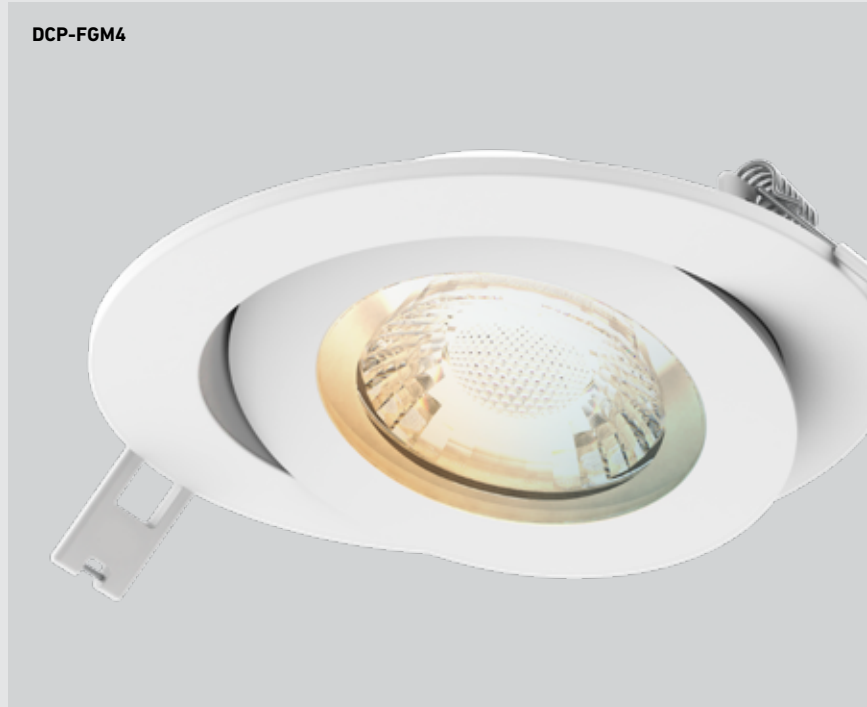

DCP-FGM4

Model	Size	Watts	Delivered lumens	CRI	Color °T	Voltage
DCP-FGM4	4"	9 W	532 lm	90	RGB + 2700 K - 6500 K	120 V



DCP-FGM4

Ø4-1/4"



Ø4-13/16"



### Specifications

Includes a junction box with integrated driver  
Full color spectrum  
2700K - 6500K in pure whites  
40° beam angle  
90° tilting, 360° rotation  
Dimmable through the Dals Connect app and the Clicc remote (DCP-RMCT)  
5-year warranty

### Finish

**WH** White

### Accessories

#### DCP-RMCT

Smart remote

#### RFP-UNI

Universal rough-in plate

#### RFP-46

Rough-in plate

### Note

Add the DALs Connect Pro Hub for even greater flexibility: voice control, remote access, expanded mesh network, ability to connect up to 128 devices per Hub.

### Download the Dals Connect app

Create groups  
Set schedules  
Remote access\*  
Compatible with Google Assistant and Amazon Alexa\*



\*Hub needed

# REVOLVE PRO

Our Recessed family has grown with a new range of adjustable downlights. The effortless design and high functionality of these fixtures are sure to make a welcome addition in any room.



DCP-GBR35



Model	Size	Watts	Delivered lumens	CRI	Color °T	Voltage
DCP-GBR35	3.5"	12 W	650 lm	90	RGB + 2700 K - 6500 K	120 V



### Specifications

Includes a junction box with integrated driver  
 Full color spectrum  
 2700K - 6500K in pure whites  
 40° beam angle  
 30° tilting, 360° rotation  
 Dimmable through the Dals Connect app and the Clicc remote (DCP-RMCT)  
 5-year warranty

### Note

Add the DALS Connect Pro Hub for even greater flexibility: voice control, remote access, expanded mesh network, ability to connect up to 128 devices per Hub.

### Finish

- **BK** Black
- **WH** White

### Accessories

- DCP-RMCT**  
Smart remote
- RFP-UNI**  
Universal rough-in plate
- RFP-46**  
Rough-in plate

### Download the Dals Connect app

Create groups  
 Set schedules  
 Remote access\*  
 Compatible with Google Assistant and Amazon Alexa\*



\* Hub needed

### DCP-GBR35

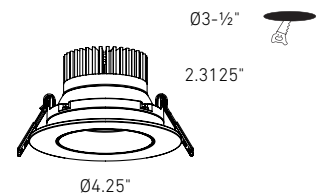

# ETCH PRO

With reduced glare and a sleek and minimal construction, the Dals Connect Pro regressed panel lights will be a great addition to any project. Connect 100+ devices through Bluetooth, create groups, set schedules and select from a wide range of colors, all possible with the DALS Connect App™.



Model	Size	Watts	Delivered lumens	CRI	Color °T	Voltage
DCP-DDP4WH	4"	15 W	1000 lm	90	RGB + 2700 K - 6500 K	120 V
DCP-DDP6WH	6"	20 W	1500 lm			



#### DCP-DDP4

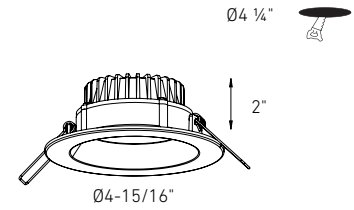

#### DCP-DDP6

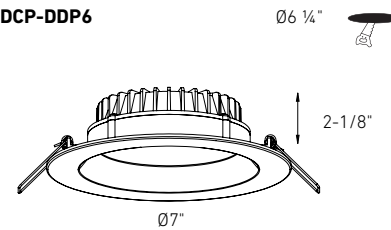

#### Specifications

Includes a junction box with integrated driver

Full color spectrum

2700K - 6500K in pure whites

125° beam angle

Dimmable through the Dals Connect app and the Clicc remote (DCP-RMCT)

5-year warranty

#### Note

Add the DALS Connect Pro Hub for even greater flexibility: voice control, remote access, expanded mesh network, ability to connect up to 128 devices per Hub.

#### Finish

**WH** White

#### Accessories

**DCP-RMCT**

Smart remote

**RFP-UNI**

Universal rough-in plate

**RFP-46**

Rough-in plate

#### Download the Dals Connect app

Create groups

Set schedules

Remote access\*

Compatible with Google

Assistant and Amazon Alexa\*



\*Hub needed

# EXCEL PRO

The Dals Connect Pro panel lights will be a great addition to any project. Connect 100+ devices through Bluetooth, create groups, set schedules and select from a wide range of colors, all possible with the DALS Connect App™.



Model	Size	Watts	Delivered lumens	CRI	Color °T	Voltage
DCP-PNL4WH	4"	14 W	750 lm	90	RGB + 2700 K - 6500 K	120 V
DCP-PNL6WH	6"	20 W	1200 lm			



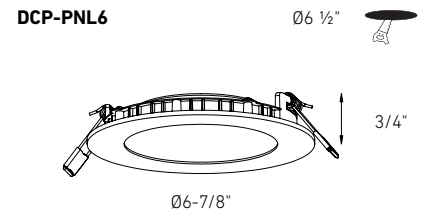
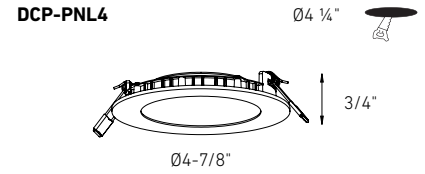

### Specifications

Includes a junction box with integrated driver  
 Full color spectrum  
 2700K - 6500K in pure whites  
 150° beam angle  
 Dimmable through the Dals Connect app and the Clicc remote (DCP-RMCT)  
 5-year warranty

### Note

Add the DALS Connect Pro Hub for even greater flexibility: voice control, remote access, expanded mesh network, ability to connect up to 128 devices per Hub.

### Finish

**WH** White

### Download the Dals Connect app

Create groups  
 Set schedules  
 Remote access\*  
 Compatible with Google Assistant and Amazon Alexa\*



\*Hub needed

### Accessories

**DCP-RMCT**  
 Smart remote

**DCP-PNL4-TRIM-BK** (DCP-PNL4WH)  
 4" recessed panel trim in black

**DCP-PNL6-TRIM-BK** (DCP-PNL6WH)  
 6" recessed panel trim in black

**RFP-UNI**  
 Universal rough-in plate

**RFP-46**  
 Rough-in plate

# BOULEVARD PRO

The Boulevard series, an architectural recessed lighting channel that can be installed in a wide range of commercial and residential environments. Add depth to ceiling planes with a visible separation, or seamlessly daisy-chained to create dramatic effects.

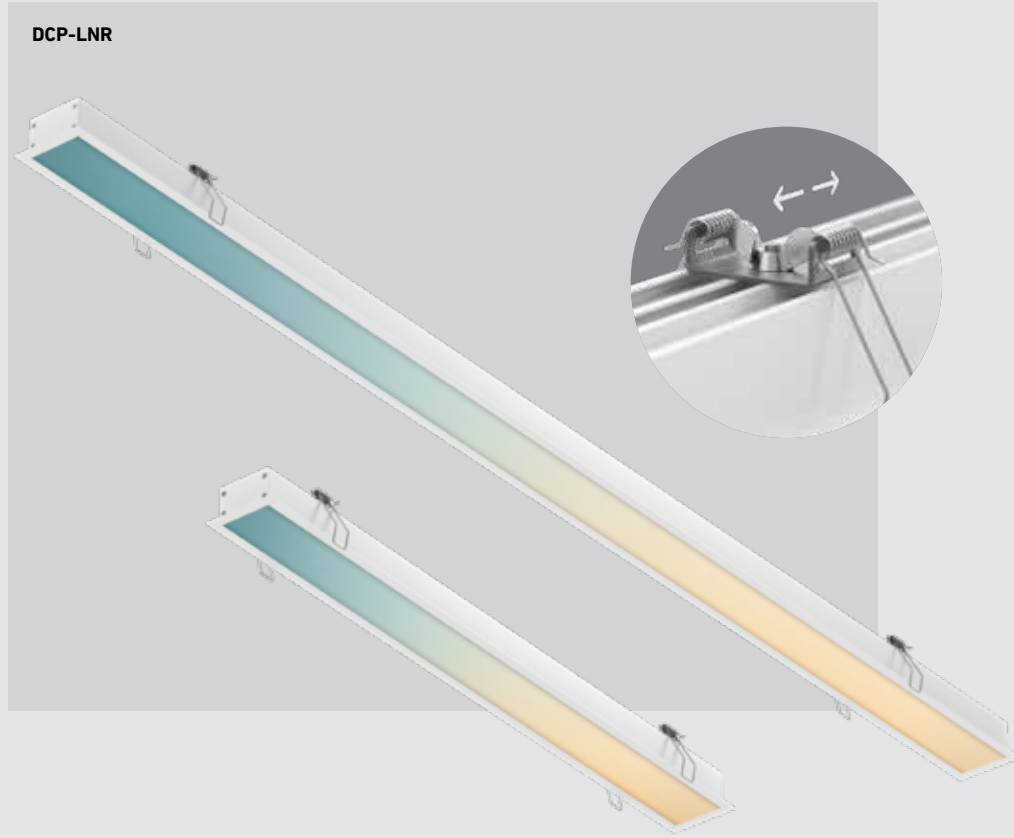

Model	Size	Watts	Delivered lumens	CRI	Color °T	Voltage
DCP-LNR24	24"	20 W	1785 lm	90	RGB + 2700 K - 6500 K	120 V
DCP-LNR48	48"	40 W	3380 lm			



**DCP-LNR24**

23-1/4" x 2-1/8"

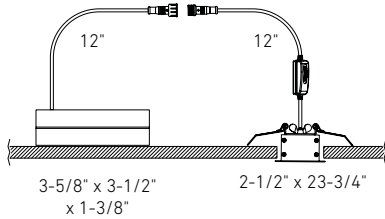
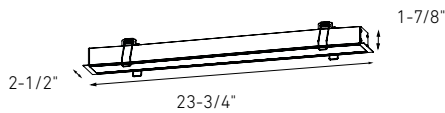
**DCP-LNR48**

47-1/4" x 2-1/8"

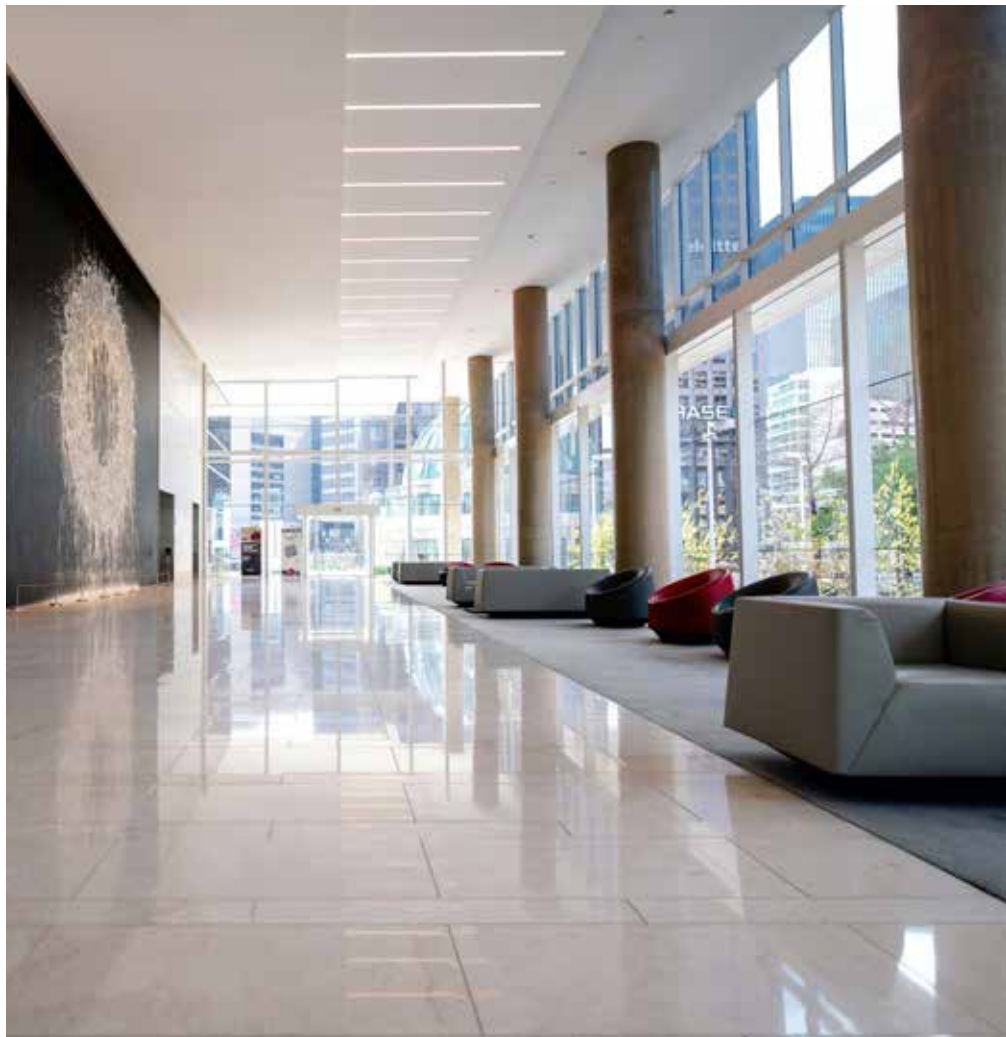
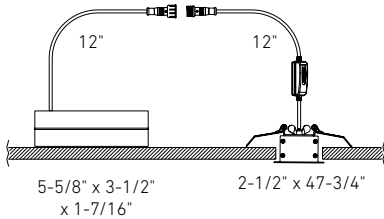
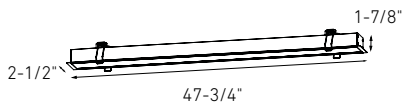
**Specifications**

Includes a junction box with integrated driver

Full color spectrum

2700K - 6500K in pure whites

108° beam angle

Dimmable through the Dals Connect app and the Clicc remote (DCP-RMCT)

5-year warranty

**Finish**

○ **WH** White

**Accessories****LNACC-L16FT**

16-foot lens for Boulevard series pendants and recessed linears

**DCP-RMCT**

Smart remote

**RFP-LNR24**

Rough-in plate for LNR24

**RFP-LNR48**

Rough-in plate for LNR48

**Note**

Add the DALS Connect Pro Hub for even greater flexibility: voice control, remote access, expanded mesh network, ability to connect up to 128 devices per Hub.

**Download the Dals Connect app**

Create groups

Set schedules

Remote access\*

Compatible with Google

Assistant and Amazon Alexa\*



\*Hub needed

# BOULEVARD PENDANT PRO

The Boulevard series, a linear modular light fixture perfect for general office, home, and shop illumination. Can be interconnected to produce striking visual effects.

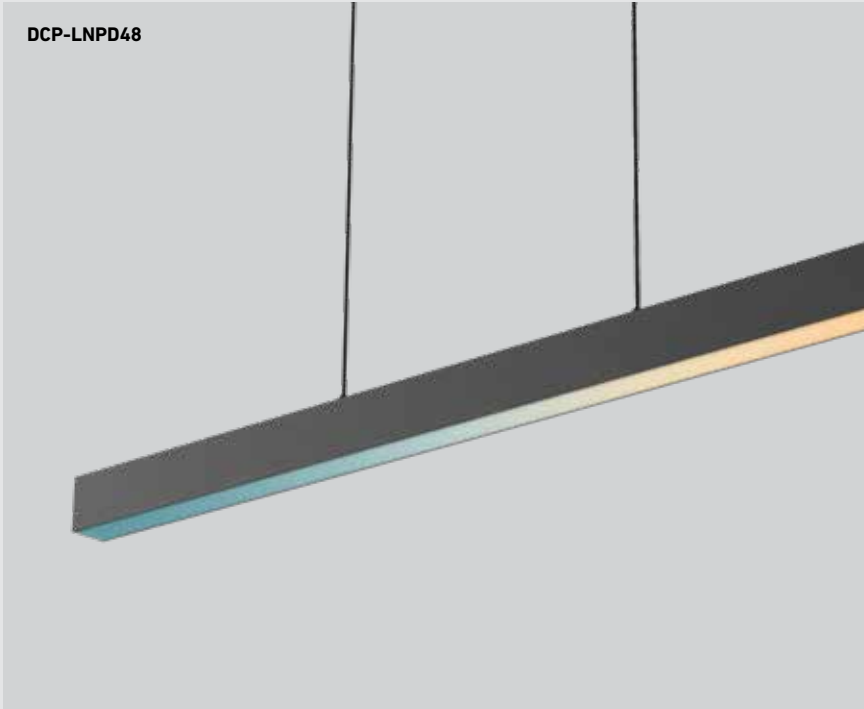

Model	Size	Watts	Delivered lumens	CRI	Color °T	Voltage
DCP-LNPD48	48"	40 W	2620 lm	90	RGB + 2700 K - 6500 K	120 V

## DCP-LNPD48

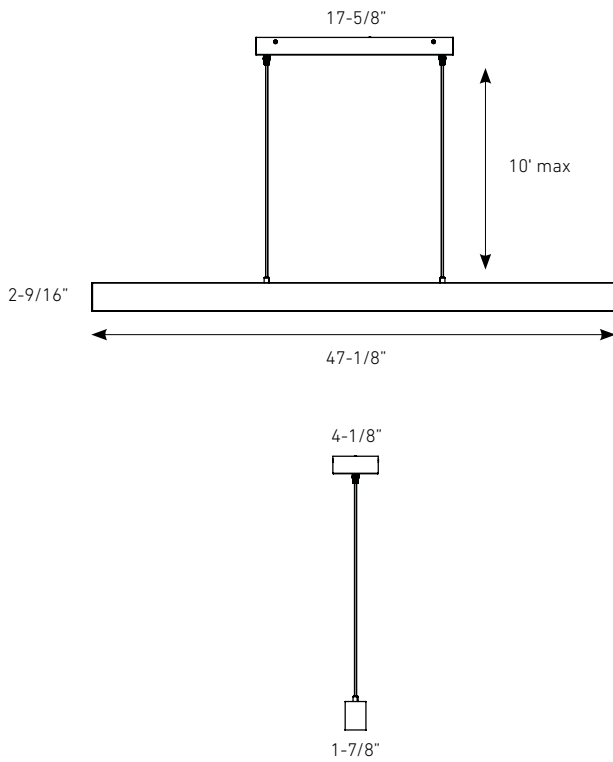

### Specifications

Includes a junction box with integrated driver  
Full color spectrum  
2700K - 6500K in pure whites  
108° beam angle  
Dimmable through the Dals Connect app and the Clicc remote (DCP-RMCT)  
5-year warranty

### Finish

● **BK** Black

### Accessories

**LNACC-L16FT**  
16-foot lens for Boulevard series pendants and recessed linears

**DCP-RMCT**  
Smart remote

### Note

Add the DALS Connect Pro Hub for even greater flexibility: voice control, remote access, expanded mesh network, ability to connect up to 128 devices per Hub.

### Download the Dals Connect app

Create groups  
Set schedules  
Remote access\*  
Compatible with Google Assistant and Amazon Alexa\*



Download on the App Store



works with Hey Google

works with alexa

\*Hub needed

# FRAME

Frame elegantly combines functionality with style, offering a dynamic lighting experience, all conveniently controlled by a sleek smart button for personalized illumination.



Model	Size	Watts	Delivered lumens	CRI	Color °T	Voltage
DCP-CGWS	12-7/8"	20 W	1000 lm	80	RGB + 2200 K - 4000 K	120 V



**DCP-CGWS**

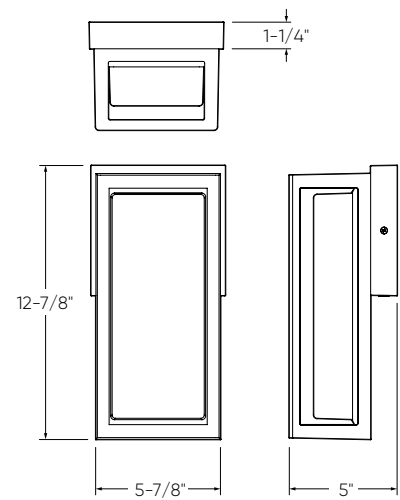

**Specifications**

Full color spectrum  
 2200K - 4000K in pure whites  
 Choose from 7 preset colors and 5 white tones directly using the button, or access additional options through the app  
 Dimmable through the Dals Connect app and the Clicc remote (DCP-RMCT)  
 Wall mount on 4" octagonal junction box  
 120° beam angle  
 5-year warranty

**Finish**

● **BK** Black

**Accessories**

**DCP-RMCT**  
 Smart remote

**Note**

Add the DALS Connect Pro Hub for even greater flexibility: voice control, remote access, expanded mesh network, ability to connect up to 128 devices per Hub.

**Download the Dals Connect app**

Create groups  
 Set schedules  
 Remote access\*  
 Compatible with Google Assistant and Amazon Alexa\*



\* Hub needed

# ARCHITECT WALL

Looking to add to your smart family products? Here is our new smart linear wall sconce. Not only decorative but also practical, this fixture can be controlled with the DALI Connect™ app and is compatible with Google Home and Amazon Alexa. So many options at your fingertips - the possibilities are endless.

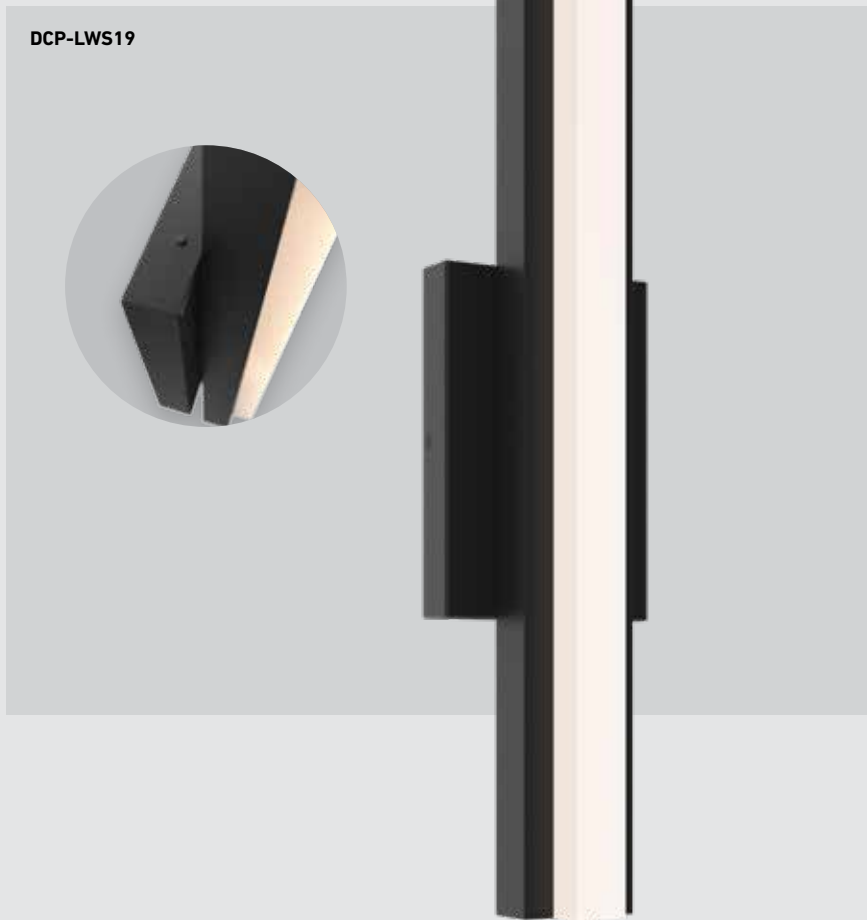

CHANGE COLORS

**ADA**  
COMPLIANT



Model	Size	Watts	Delivered lumens	CRI	Color °T	Voltage
DCP-LWS19	19"	15 W	1130 lm	80	RGB + 2200 K - 6500 K	120 V

## DCP-LWS19

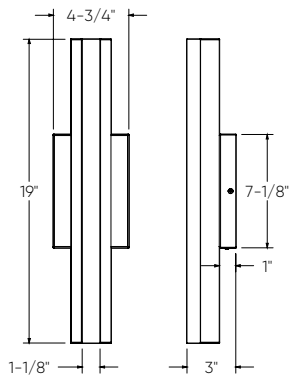

### Specifications

Made of extruded aluminum  
Full color spectrum  
2700K - 6500K in pure whites  
Choose from 7 preset colors and 5 white tones directly using the button, or access additional options through the app  
Dimmable through the Dals Connect app and the Clicc remote (DCP-RMCT)  
Wall mount on 4" octagonal junction box  
5-year warranty

### Finish

● **BK** Black

### Accessories

**DCP-RMCT**  
Smart remote

### Download the Dals Connect app

Create groups  
Set schedules  
Remote access\*  
Compatible with Google Assistant and Amazon Alexa\*

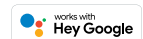

\*Hub needed



NEW

# GLOW

The 10, 20, and 50-foot smart tape features a full RGB color range and tunable white light, enabling users to adjust from warm to cool tones—perfect for adding dynamic and personalized lighting to any space.

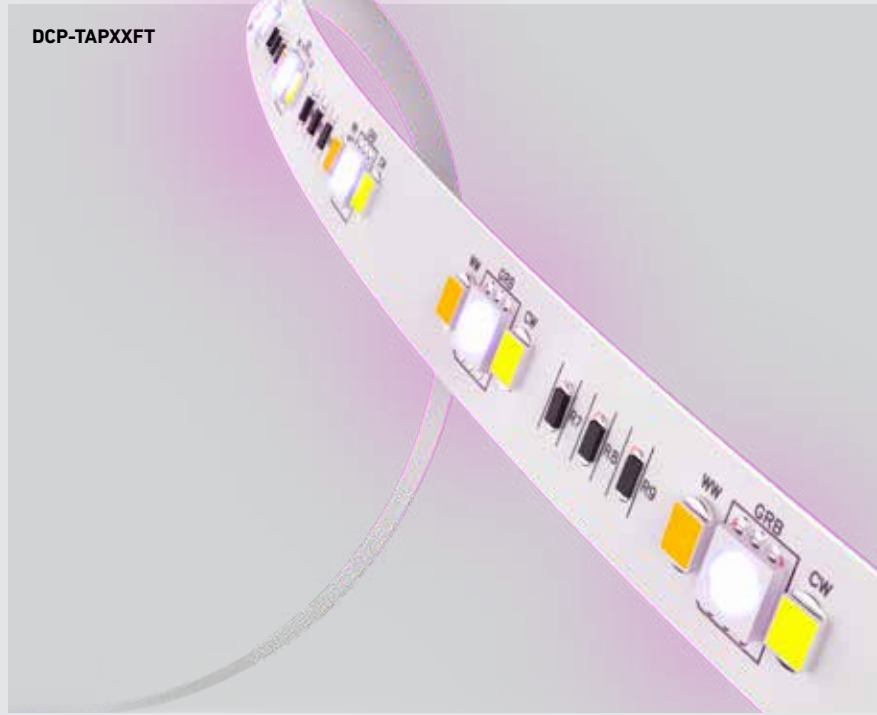

Model	Size	Watts	Delivered lumens	CRI	Color °T	Voltage
DCP-TAP10FT	10'	9 W	700 lm	80	RGB + 2700 K - 6500 K	24 VDC
DCP-TAP20FT	20'	16 W	1200 lm			
DCP-TAP50FT	50'	19 W /per 25'	1400 lm /per 25'			





### DCP-TAP10FT / DCP-TAP20FT

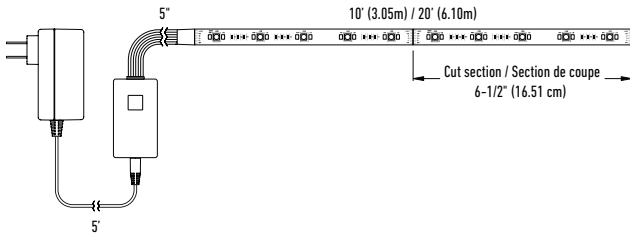

### DCP-TAP50FT

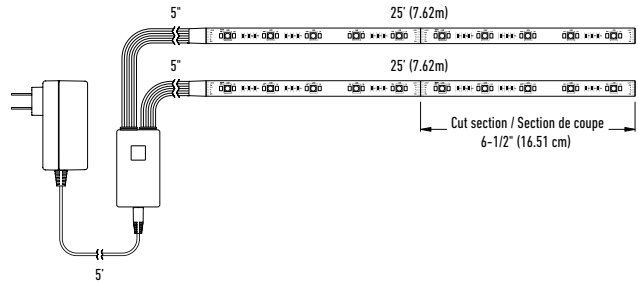

### Specifications

Full color spectrum  
 2700K - 6500K in pure whites  
 Includes a wired controller with smart button for CCT selection, color customization and on/off control  
 Dimmable through the Dals Connect app and the Clicc remote (DCP-RMCT)  
 5-year warranty

### Finish

**WH** White

### Accessories

**DCP-RMCT**  
 Smart remote

### Note

Add the DALs Connect Pro Hub for even greater flexibility: voice control, remote access, expanded mesh network, ability to connect up to 128 devices per Hub.

### Download the Dals Connect app

Create groups  
 Set schedules  
 Remote access\*  
 Compatible with Google Assistant and Amazon Alexa\*



\* Hub needed

# AXIS PRO

The digital Axis 20" table lamp and 50" floor lamp let you adjust individual segments for precise illumination, offering a fully personalized lighting experience. Additionally, select from a range of pre-designed smooth animations to create the perfect mood.

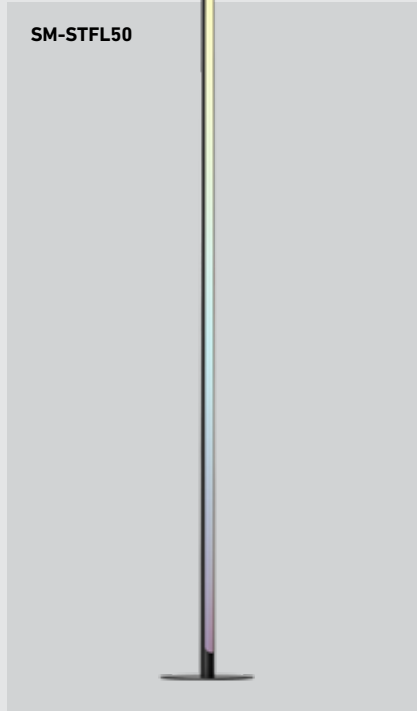
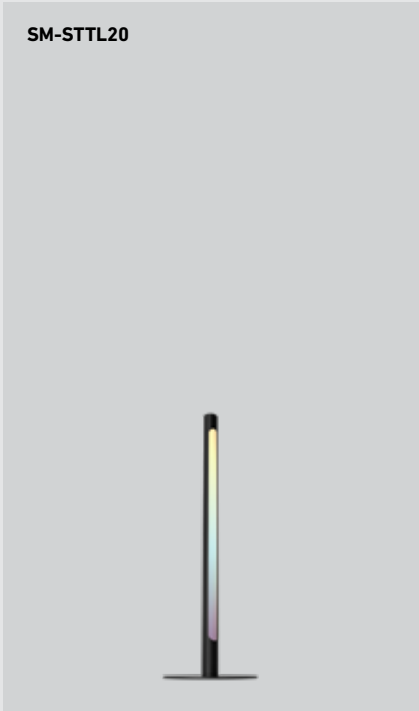

Model	Size	Watts	Delivered lumens	CRI	Color °T	Voltage
SM-STTL20	20"	7 W	360 lm	80+	RGB + 2200 K - 6500 K	120 V
SM-STFL50	50"	14 W	720 lm			

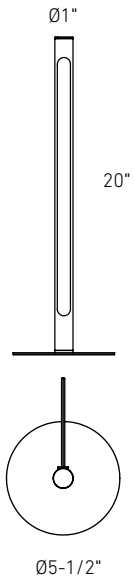
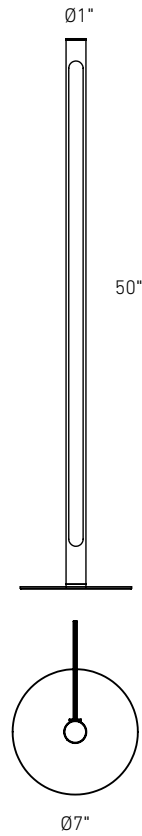
**SM-STTL20****SM-STFL50****Specifications**

Full color spectrum  
 2700K - 6500K in pure whites  
 Create gradients  
 Preset animations  
 Aluminum construction  
 On-cord on/off physical switch  
 Dimmable through the Dals Connect app and the Clicc remote (DCP-RMCT)  
 5-year warranty

**Finish**

● **BK** Black

**Download the Dals Connect app**

Wi-Fi - no hub needed  
 Create groups  
 Set schedules  
 Remote access  
 Compatible with Google Assistant and Amazon Alexa



# A21 PRO

Enter the world of Smart lighting with our array of dimmable LED Bluetooth controlled bulbs that emit a full spectrum of vibrant colors or tunable pure whites ranging from 2700 to 6500 K.



Model	Size	Watts	Delivered lumens	CRI	Color °T	Voltage
DCP-BLBA21	A21	12 W	1100 lm	90	RGB + 2700 K - 6500 K	120 V

## DCP-BLBA21

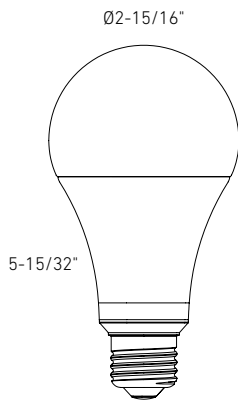

### Specifications

Full color spectrum  
2700K - 6500K in pure whites  
Suitable for enclosed fixtures  
Dimmable through the Dals Connect app and the Clicc remote (DCP-RMCT)  
5-year warranty

### Finish

**WH** White

### Accessories

**DCP-RMCT**  
Smart remote

### Note

Add the DALS Connect Pro Hub for even greater flexibility: voice control, remote access, expanded mesh network, ability to connect up to 128 devices per Hub.

### Download the Dals Connect app

Create groups  
Set schedules  
Remote access\*  
Compatible with Google Assistant and Amazon Alexa\*



\*Hub needed

# BR30 PRO

Enter the world of Smart lighting with our array of dimmable LED Bluetooth controlled bulbs that emit a full spectrum of vibrant colors or tunable pure whites ranging from 2700 to 6500 K.



Model	Size	Watts	Delivered lumens	CRI	Color °T	Voltage
DCP-BLBBR30	BR30	12 W	1200 lm	90	RGB + 2700 K - 6500 K	120 V



## DCP-BLBBR30

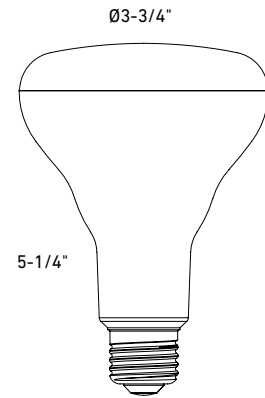

### Specifications

Full color spectrum  
 2700K - 6500K in pure whites  
 Minimal heat emission  
 Dimmable through the Dals Connect app and the Clicc remote (DCP-RMCT)  
 5-year warranty

### Finish

**WH** White

### Accessories

**DCP-RMCT**  
 Smart remote

### Note

Add the DALS Connect Pro Hub for even greater flexibility: voice control, remote access, expanded mesh network, ability to connect up to 128 devices per Hub.

### Download the Dals Connect app

Create groups  
 Set schedules  
 Remote access\*  
 Compatible with Google Assistant and Amazon Alexa\*



\*Hub needed

# CLICC

Upgrade your home automation with the Clicc smart remote and enjoy the perfect combination of local control and app integration for a seamlessly connected smart home experience. Effortlessly integrate your Dals Connect Pro products for centralized control over multiple devices. The remote is easily detachable from its wall plate, allowing you to take it anywhere in your home. Adjust color temperatures, dim the lights, or select vibrant hues—all with ease from this versatile remote.



DCP-RMCT



Model	Size	Programmable	Wall adapter	Number of supported devices	Battery
DCP-RMCT	2 5/8"	√	√	100	CR2032



## DCP-RMCT

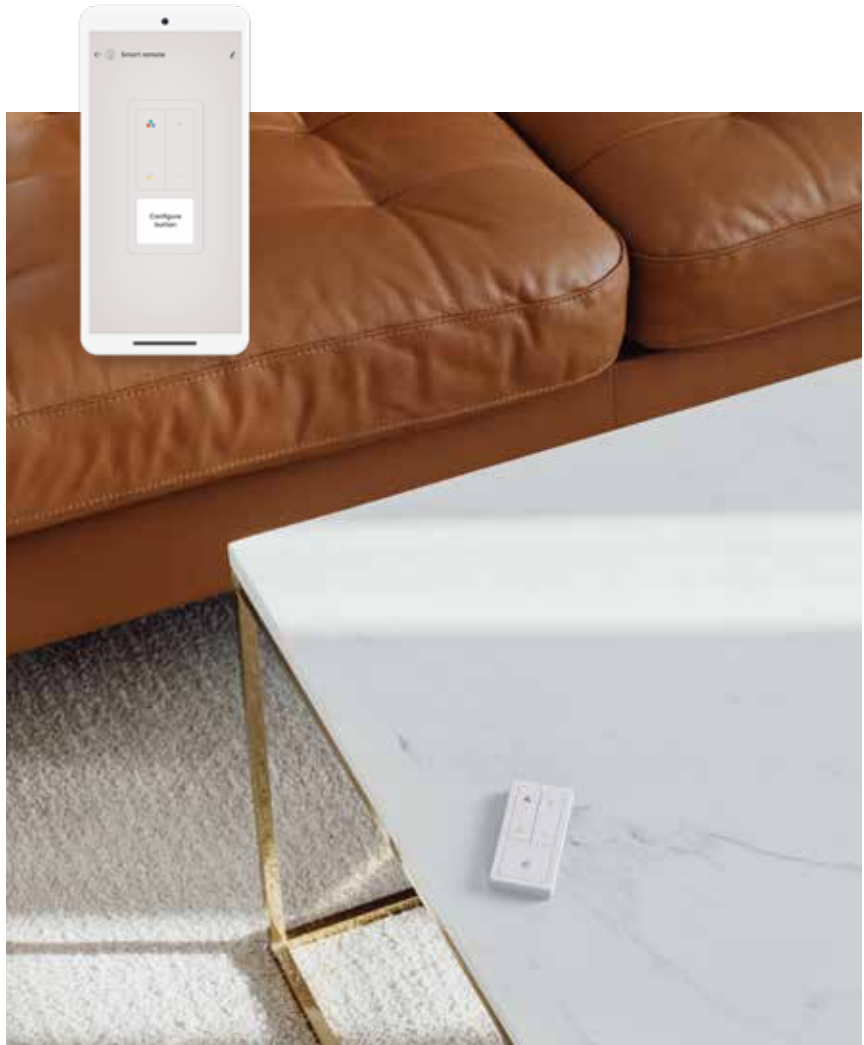
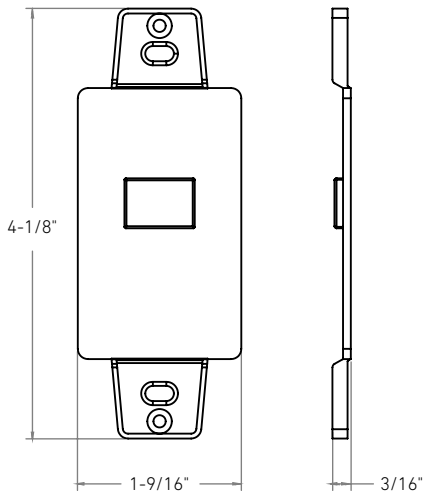
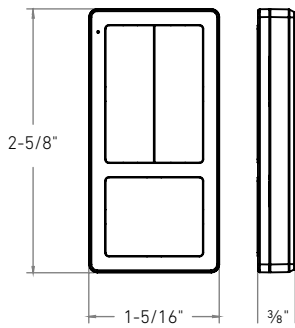

### Specifications

Indoor use only  
Controls any Dals Connect Pro device  
Tune whites, change colors, dim or turn on/off the lights  
Control your lights locally, without an internet connection, directly from the remote  
Fits any decorator wall plate (not included)  
Includes remote, CR2032 battery and magnetic wall plate adapter  
5-year warranty

### Finish

**WH** White

### Download the Dals Connect app



# SMART DIMMER SWITCH

In need of a dimmer but not sure which one to get? Look no further. With the DALS Connect™ app, you will be able to create groups, set timers and much more. This is a great way to get to know smart home technologies and perhaps convince you to come and join us on the smart side with our ever growing smart product line.



SM-DIMSW



Model	Size	Dimmer	Scheduling	Sunrise & Sunset setting	Alexa & Google Assistant compatible	Voltage
SM-DIMSW	4 1/2"	✓	✓	✓	✓	120 V

## SM-DIMSW

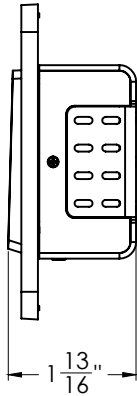
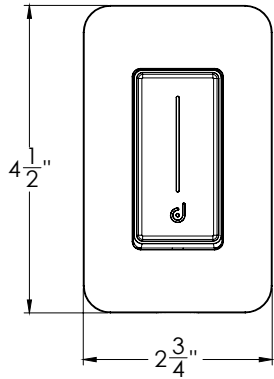

### Specifications

Indoor use only  
Control from the wall switch or with the Dals Connect app  
LED brightness indicator  
Touch-sensitive slide dimmer  
Works with all "non-smart" standard lights  
Dimming type: TRIAC Edge cut  
Inductive load (LED-CFL): 250W max.  
Resistive load (incan.): 430W max.  
Standby power: 1W  
5-year warranty

### Finish

**WH** White

### Note

Does not work with Dals smart lights.  
Requires a neutral wire. Works in a single-pole setup only. Secured 2.4 GHz wireless network required.

### Download the Dals Connect app

Wi-Fi - no hub needed  
Create groups  
Set schedules  
Remote access  
Compatible with Google Assistant and Amazon Alexa



# INDEX

2000-EXT20FT.....	81
2003 .....	72
2004 .....	72
2006 .....	72
4000-E24 .....	106
4000-E60 .....	106
4000HRNS-24.....	106
4001-CC.....	91
4005-CC .....	92
K4005-CC.....	92
5000-EXT8FT.....	81
5000-EXT20FT.....	81
5003-CC .....	70
5004-CC .....	70
5005-CC .....	70
5006-CC .....	70
5004SQ-CC.....	70
6000-ACCE06.....	111
6000-ACCE24.....	111
6000-ACCE60.....	111
6000-ACCLR.....	111
6000-ACCPC.....	111
6000-JB.....	110
6000-JB.....	111
6001-CC.....	98
6001-E24.....	110
6001-E60.....	110
6001-PC.....	110
6009C.....	99
6012CC.....	99
6024CC.....	99
6036CC.....	99
6048CC.....	99
9000-ACCE24.....	111
9000-ACCE72.....	111
9009CC.....	102
9012CC.....	102
9018CC.....	102
9024CC.....	102
9030CC.....	102

## B

BRPD18-CC.....	136
BRPD40-CC.....	136
BRV24-CC.....	136
BRV36-CC.....	136
BT06DIM-IC.....	104
BT12DIM-IC.....	104
BT24DIM-IC.....	104
BT36DIM.....	104
BT48DIM.....	104

## C

CAPD72-CC.....	122
CAPD-ACLL.....	242
CAPD-ACCLS.....	242
CCFM-CC.....	170
CFG13-CC.....	178

CFH12-CC.....	176
CFLEDR6-CC.....	182
CFLEDR10-CC.....	182
CFLEDR14-CC.....	182
CFLEDR18-CC.....	182
CFLEDR24-CC.....	182
CFLEDSQ6-CC.....	182
CFLEDSQ10-CC.....	182
CFLEDSQ14-CC.....	182
CFPD20-CC.....	154
COBTB-EXT60.....	107
COBT3M.....	88
COBT5M.....	88
COBTP-REEL.....	88
COBTP24V-K10FT-CC.....	96
COBTP24V-K20FT-CC.....	96
COBTP24V-R50FT-CC.....	96
COBTP24V-R100FT-CC.....	96
COBTP24V-ACCI.....	109
COBTP24V-ACCL.....	109
COBTP24V-CC36.....	109
COBTP24V-ETR30.....	109
COBTP24V-ETR60.....	109
COBTP24V-EXT24.....	109
COBTP24V-EXT60.....	109
COBTP24V-EXT120.....	109
COBTP24V-SWT.....	109
COBTP-ALXT-BK.....	107
COBTP-ALXT-L5M-BK.....	107
COBTP-ALXT-L5M-WH.....	107
COBTP-ALXT-WH.....	107
COBTP-CC06.....	107
COBTP-EXT02.....	107
COBTP-EXT24.....	107
CYL05-CC.....	168
CYL06-CC-V.....	168
CYL05-TRIM-AZ.....	242
CYL05-TRIM-BK.....	242
CYL05-TRIM-GD.....	242
CYL05-TRIM-WH.....	242
CYL06-TRIM-AZ.....	242
CYL06-TRIM-BK.....	242
CYL06-TRIM-GD.....	242
CYL06-TRIM-WH.....	242

## D

DCP-45HP20.....	284
DCP-ACC-MB.....	297
DCP-ACC-MS06.....	297
DCP-ACC-MS12.....	297
DCP-BLBA21.....	326
DCP-BLBBR30.....	328
DCP-BRK12.....	288
DCP-CGWS.....	318
DCP-CPL24.....	280
DCP-DDP4.....	310
DCP-DDP6.....	310
DCP-FGM4.....	306

DCP-FLD30.....	286
DCP-GBR35.....	308
DCP-HUB.....	304
DCP-LNPD48.....	316
DCP-LNR24.....	314
DCP-LNR48.....	314
DCP-LWS19.....	320
DCP-NFTAP5M.....	290
DCP-PNL4.....	312
DCP-PNL6.....	312
DCP-PTR36.....	297
DCP-RK10.....	294
DCP-RK18.....	294
DCP-RMCT.....	330
DCP-SPT6.....	278
DCP-SPTACCLENS.....	297
DCP-SPTTEXT14.....	297
DCP-STG48.....	292
DCP-STGACCLB.....	297
DCP-STGACPCB.....	297
DCP-STK20.....	282
DCP-STK50.....	282
DCP-TAPXXFT.....	322
DCP-TR60.....	276
DCP-TR200.....	276
DCP-TR300.....	276
DD1260.....	95
DDP4-CC.....	40
DDP6-CC.....	40
DDP4-TRIM-BK.....	81
DDP6-TRIM-BK.....	81
DR2412DIM.....	104
DR2424DIM.....	104
DR2448DIM.....	104
DR2460DIM.....	104
DR2496DIM.....	104
DRR2-CC.....	38
DRR4-CC.....	38
DRR6-CC.....	38
DRR4-TRIM-BK.....	81
DRR4-TRIM-SBA.....	81
DRR6-TRIM-BK.....	81
DRR6-TRIM-SBA.....	81
DSWC05-CC.....	222
DSWC07-CC-V.....	222

## F

FDB-CC.....	146
FGM4-3K.....	60
FGM2-CC.....	60
FGM3-CC.....	60
FGM4-CC.....	60
FGM6-CC.....	60
FGM4SQ-CC.....	60
FGM6SQ-CC.....	60
FGM4-CC-DUO.....	60
FGM4-CC-TRIO.....	60
FMM09-CC.....	186

FMM12-CC.....	186
FMP05-CC-CR.....	188
FMP05-CC.....	188
FMP05M-CC.....	188
FMP09-CC.....	188
FMP12-CC.....	188
FMP09-CC-CR.....	188
FMP12-CC-CR.....	188
FMT18-CC.....	172
FPD60-CC.....	146
FPD-CC.....	146
FPDC3-CC.....	146
FUZ11-CC.....	174

## G

GBR35-CC.....	56
GBR04-CC.....	56
GBR06-CC.....	56
GBR35-DW.....	56
GBR04-DW.....	56
GBR06-DW.....	56
GBR35SQ-CC.....	56
GBR35-CC-DUO.....	56
GBR35-CC-TRIO.....	56
GMB2-CC.....	64
GMB4-CC.....	64
GL-CFG13-CC.....	242
GMB2-GOOF.....	80
GPN4-CC.....	66
GPN6-CC.....	66
GPN-CC-EXT8FT.....	81
GPN-CC-EXT20FT.....	81
GRD2-CC.....	256
GSP3-CC.....	54
GSP-CC-EXT8FT.....	81
GSP-CC-EXT20FT.....	81

## H

HLF09.....	100
HLF12.....	100
HLF18.....	100
HLF24.....	100
HLF30.....	100
HPD4-CC.....	48
HPD6-CC.....	48
HPD8-CC.....	48

## I

IND4-DW.....	42
IND6-DW.....	42
IRPD-CC.....	120

## K

K4005-CC.....	92
---------------	----

## L

LAN-ACC-MS.....	296
LAN-ACC-PS.....	296

LCBL-50-14	296
LCBL-50-14	297
LCBL-50-16	296
LCBL-50-16	297
LCBL-100-12	296
LCBL-100-12	297
LCBL-100-14	296
LCBL-100-14	297
LCBL-100-16	296
LCBL-100-16	297
LCBL-200-12	296
LCBL-200-12	297
LEDDOWNACC-GOOF3	80
LEDDOWNACC-GOOF4	80
LEDDOWNACC-GOOF6	80
LEDDOWNG3-CC	64
LEDHRNS-6	106
LEDPATH004D	268
LEDPNLRTF56-CC	76
LEDRDM1	93
LEDRDP18	94
LEDSTEP002D-CC	234
LEDSTEP004D-CC	236
LEDSTEP005D-CC	238
LEDVAN001-CC-18	200
LEDVAN001-CC-24	200
LEDVAN002-CC-24	202
LEDVAN002-CC-36	202
LEDVAN003-CC-24	204
LEDVAN003-CC-32	204
LEDWALL001D-CC	230
LEDWALL-A	216
LEDWALL-B	218
LEDWALL-E	220
LEDWALL-G-CC	224
LEDWALL-H	226
LHS07-CC	264
LNACC-L16FT	242
LNFM48-CC	124
LNP48-CC	124
LNP48-CC	124
LNP48-CC	124
LNR24-CC	50
LNR48-CC	50
LPP20-CC	260
LRB20-CC	262
LRB30-CC	262
LSP3-ACCLN	296
LSP3-CCL	254
LSP4-CCL	254
LSP4-ACCLN	296
LSP-EXT04	296
LSP-WM	296
LSQP-ACC-PS	296
LSQP-CC	258
LSS10-CC	252
LSTP07-CC	240
LSTP12-CC	232
LTRP-60	266

LTR-300	266
LWJ08-CC	214
LWJ16-CC	214
LWJ24-CC	214

## M

MFD03-CC	52
MSL1-CC	44
MSL2-CC	44
MSL4-CC	44
MSL5-CC	44
MSL10-CC	44
MSL5G-CC	44
MSL10G-CC	44
MSLPD48-CC	126
MSLWALL-CC	126

## N

NAPF20-CC	118
NAPF20-CC	118

## P

PDC18-CC	164
PDLED120-24	166
PDLED120-36	166
PDLED120-48	166
PDLED120-60	166
PDLED120-5	166
PDLED120-5SQ	166
PDLED120-8	166
PDLED120-8SQ	166
PDR14-CC	150

## R

RC-03-CC	28
RC-04-CC	28
RC-06-CC	28
REC-3K-EXT8FT	81
REC-3K-EXT20FT	81
REC-CC-EXT8FT	81
REC-CC-EXT20FT	81
REC-GOOF2	80
REC-PT4-GD	81
REC-TRIM4-BK	81
REC-TRIM4-GD	81
REC-TRIM4-SN	81
REC-TRIM6-BK	81
REC-TRIM6-GD	81
REC-TRIM6-SN	81
RFP-23	78
RFP-35	78
RFP-46	78
RFP-58	78
RFP-DUO	80
RFP-GMB2	78
RFP-LNR24	80
RFP-LNR48	80
RFP-MSL1	79

RFP-MSL2	79
RFP-MSL4	79
RFP-MSL5	79
RFP-MSL5G	79
RFP-MSL10	79
RFP-MSL10G	79
RFP-RC06	78
RFP-TRIO	80
RFP-UNI	78
RGM2-CC	32
RGM4-CC	32
RGM6-CC	32
RGPD24-CC	148
RGR1-CC	34
RGR2-CC	34
RGR4-CC	34
RGR6-CC	34
RGR2-CC	34
RGR4-HP-CC	34
RGR4-CC	34
RGR6SQ-CC	34
RRPD2-CC	138
RRPD5-CC	138
RTJB4-3K	74
RTJB3-CC	74
RTJB4-CC	74
RTJB4-ACC	81
RTJB4-TRIM-BK	81
RTL-3C	250
RWS24-CC	210
RWS48-CC	210
RWS60-CC	210

## S

SLPD60-CC	132
SM-DIMSW	332
SM-STTL20	324
SM-STFL50	324
SPD48-CC	128
SPD72-CC	128
SPN4-CC	68
SPN6-CC	68
SPR20-CC	140
SPR34-CC	140
SQS06-NUM-BK	242
SQS06-CC	228
SQS10-CC	228
SQS15-CC	228
SQS10-NUM-BK	242
SQS15-NUM-BK	242
SQSTP-CC	228
SSFM20-CC	158
SSPD32-CC	158
STK21-CC	160
STK37-CC	160
STRFL-3K	160
STRFM-3K	160
STRPD-3K	160

SWIVLED12-CC	90
SWIVLED-CC10-OUTPUT108	
SWIVLEDACC-45VCLIP	108
SWIVLEDCC-EXT10	108
SWIVLEDCC-EXT36	108
SWIVLEDCC-EXT60	108
SWS24-CC	208
SWS36-CC	208
SWS48-CC	208
SWS60-CC	208

## T

TLFM12-CC	180
TLFM21-CC	180
TRFM22-CC	152
TRPD34-CC	152
TWPD-CC	144
TWPS-3K	142

## V

VAL24-CC	192
VAL36-CC	192
VA032-CC	190
VA024-CC	190
VCC24-CC	194
VCC36-CC	194
VDL40-CC	196
VLG24-CC	206
VLG36-CC	206
VSW24-CC	198
VSW36-CC	198

## W

W1PD48-CC	134
W3FM-CC	134
W3PD36-CC	134



**Canada**

80, blvd. de la Seigneurie, East  
Blainville, Quebec J7C 4N1  
450 430 1818

**U.S.A**

4383, NW 124<sup>th</sup> Ave.,  
Coral Springs, Florida 33065

**Customer service**

877 430 1818

For information regarding distributors  
and points of sale please visit our website  
[dals.com](http://dals.com) or email: [info@dals.com](mailto:info@dals.com)



[dals.com](http://dals.com)



LIGHTING DESIGN GUIDE

